



USER MANUAL

MODEL:

KDS-SW3-EN7 4K AVoIP Encoder with Dante



Contents

Introduction	3
Getting Started	3
Overview	4
Typical Applications	5
Defining KDS-SW3-EN7	6
LED Functionality	7
Mounting KDS-SW3-EN7	8
Connecting KDS-SW3-EN7 and KDS-DEC7	9
Connecting the Audio Input/Output	10
Connecting to KDS-SW3-EN7 via RS-232	11
Connecting to KDS-SW3-EN7 via Ethernet	11
Fast switching configuration	14
Operating and Controlling from the Front Panel	15
Using the Menu Navigation Button	15
Using the LCD Display Menu	16
Identifying the IP Address	16
Setting the Channel Number	17
Setting the Input Port	17
Viewing Version Information	17
Selecting the EDID	18
Defining HDCP Settings	18
Operating and Controlling from the Embedded Web Pages	19
Opening the Embedded Web Pages	20
Defining AV Routing Parameters	21
Defining Auto Switching	22
Defining Signal Loss Timeouts	23
Defining HDMI Input Settings	24
Defining Audio Settings	25
Defining Dante Audio as a Source or Destination	26
Managing EDID	27
General Device Settings	29
KDS-SW3-EN7 Network Settings	33
Defining KDS-SW3-EN7 Time and Date	36
Setting KDS-SW3-EN7 Security	37
Defining KDS-SW3-EN7 User Access	40
Defining KDS-SW3-EN7 Gateway Settings	43
Viewing KDS-SW3-EN7 Status	46
Viewing KDS-SW3-EN7 Connections Status	47
Viewing KDS-SW3-EN7 Advanced Status	48
Viewing the About Page	49
Upgrading Firmware	50
Technical Specifications	51
KDS-SW3-EN7 Specifications	51
Default Communication Parameters	53
Default EDID	53
Default Parameters	56
Protocol 3000	58
Understanding Protocol 3000	58
Protocol 3000 Commands	59
Result and Error Codes	74

Introduction

Welcome to Kramer Electronics! Since 1981, Kramer Electronics has been providing a world of unique, creative, and affordable solutions to the vast range of problems that confront the video, audio, presentation, and broadcasting professional on a daily basis. In recent years, we have redesigned and upgraded most of our line, making the best even better!

Getting Started

We recommend that you:

- Unpack the equipment carefully and save the original box and packaging materials for possible future shipment.
- Review the contents of this user manual.



to www.kramerav.com/downloads/KDS-SW3-EN7 to check for up-to-date user manuals, application programs, and to check if firmware upgrades are available (where appropriate).

Achieving Best Performance

- Use only good quality connection cables (we recommend Kramer high-performance, high-resolution cables) to avoid interference, deterioration in signal quality due to poor matching, and elevated noise levels (often associated with low quality cables).
- Do not secure the cables in tight bundles or roll the slack into tight coils.
- Avoid interference from neighboring electrical appliances that may adversely influence signal quality.
- Position your Kramer **KDS-SW3-EN7** away from moisture, excessive sunlight and dust.

Safety Instructions



Caution:

- This equipment is to be used only inside a building. It may only be connected to other equipment that is installed inside a building.
- For products with relay terminals and GPIO ports, please refer to the permitted rating for an external connection, located next to the terminal or in the User Manual.
- There are no operator serviceable parts inside the unit.



Warning:

- Use only the power cord that is supplied with the unit.
- To ensure continuous risk protection, replace fuses only according to the rating specified on the product label which is located on the bottom of the unit.

Recycling Kramer Products

The Waste Electrical and Electronic Equipment (WEEE) Directive 2002/96/EC aims to reduce the amount of WEEE sent for disposal to landfill or incineration by requiring it to be collected

and recycled. To comply with the WEEE Directive, Kramer Electronics has made arrangements with the European Advanced Recycling Network (EARN) and will cover any costs of treatment, recycling and recovery of waste Kramer Electronics branded equipment on arrival at the EARN facility. For details of Kramer's recycling arrangements in your particular country go to our recycling pages at www.kramerav.com/il/quality/environment.

Overview

Congratulations on purchasing your Kramer **KDS-SW3-EN7 4K AVoIP Encoder with Dante**. **KDS-SW3-EN7** is an auto switcher and advanced encoder for streaming a selected video signal at 4K@60Hz via Ethernet over copper cable in unicast (one-to-one) or multicast (one-to-many) configurations. It can add digital audio Dante (AES-67 is not supported), USB, IR, RS-232, or CEC signals.

KDS-SW3-EN7 encodes and streams the video signal from one of three selectable inputs: HDMI IN 1, HDMI IN 2 or USB-C input. It transmits de-embedded HDMI audio to digital Dante, USB, IR, RS-232, or CEC signals over an IP network. The Kramer **KDS-SW3-EN7** receives data traffic from **KDS-DEC7** USB devices.

KDS-SW3-EN7 provides exceptional quality, advanced user-friendly operation, and flexible control.

Exceptional Quality

- Instantaneous Switching Time – 1 second switching time between selectable video inputs.
- Video Streaming Transmitter - Streams up to 4K@60Hz (4:2:0) resolution signals over a 1G network interface. While **KDS-DEC7** decodes the stream to 4K@30Hz (4:4:4) resolution.
- Streaming delay 33msec for video 4K@30Hz 4:4:4 signal.
- HDR Support – HDR10 up to 4K@30Hz 4:2:2 12bits.
- Streaming Support – Provides unicast and multicast streaming.
- Flexible **Analog** Audio Embedding and De-embedding - Select **balanced analog audio** as input to embed into the streaming and HDMI™ output signal, or as output to extract the HDMI audio signal and output it as balanced analog audio.
- Flexible **Digital** Audio Embedding and De-embedding Dante - Select **digital audio** as input to embed into the streaming and HDMI™ output signal, or as output to extract the HDMI audio signal and output it as balanced analog audio.
- Easy To Use KM/KVM Support – Searchable, OSD menu for KM and fully configurable KVM roaming.
- Power consumption without USB-C Power Delivery is 13W, and power consumption with USB-C Power Delivery is 77W (requiring the optional power supply).

Advanced and User-friendly Operation

- Convenient and Comprehensive Control – Control the unit using intuitive embedded web pages, Protocol 3000 API commands via Ethernet, or front panel LCD and navigation buttons.
- PoE Support – Powered with PoE connection from PoE LAN switch.
- Control Gateway - Through P3K or special TCP connection, users can control/communicate with IR, RS-232, or CEC to the connected devices.
- Separate Service LAN Port – can be used for physical separation between AV and command streams to separate LAN for security and reliability purposes.

Flexible Connectivity

- Selectable Inputs – 2 HDMI and 1 USB-C input.
- Analog/Digital audio inputs and outputs.
- Plug-and-play with Netgear M4250 AVoIP switches, Kramer Control, and KDS-USB2.

Typical Applications

KDS-SW3-EN7 is ideal for the following typical applications:

- Real-time essential installations such as command and control rooms.
- Large scale AV content sharing installations using existing wires and infrastructure in corporate offices and government applications.
- AV distribution systems with one or more sources and multiple displays in schools, universities, and public venues.
- AV installations where low latency KM/KVM capabilities are required.

Controlling your KDS-SW3-EN7

Control your KDS-SW3-EN7 directly via Navigation buttons, or via:

- The Ethernet using built-in user-friendly web pages.
- Protocol commands.
- KDS-7-MNGR.

Defining KDS-SW3-EN7

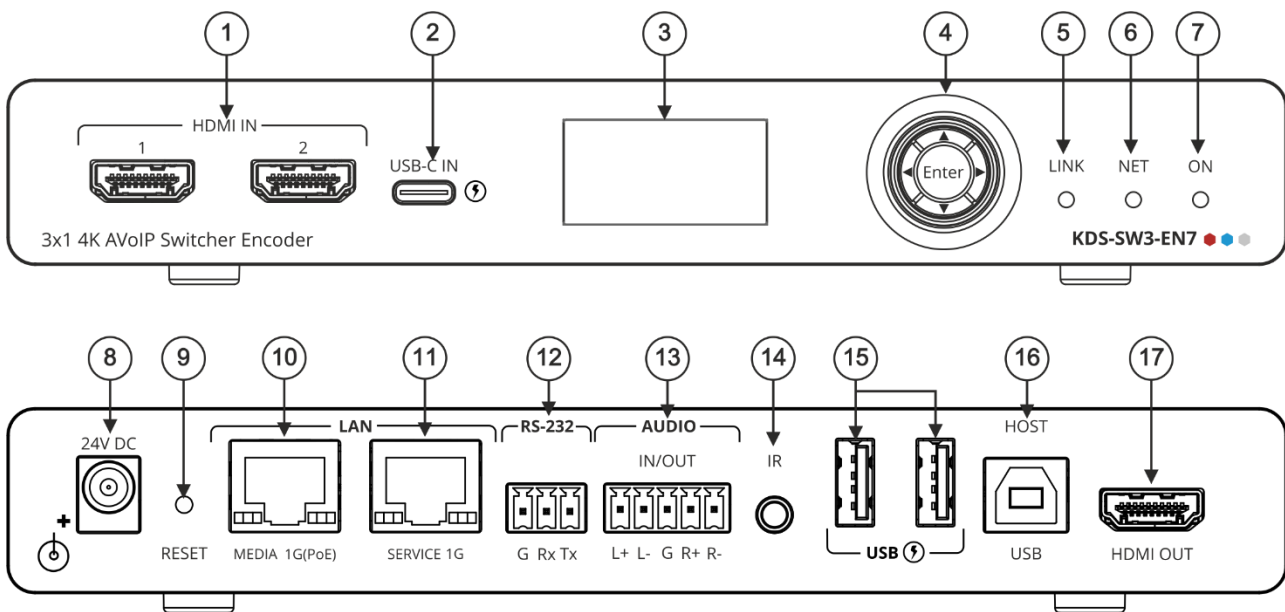

Figure 1: KDS-SW3-EN7 4K AVoIP Encoder

#	Feature	Function	
①	HDMI IN Connectors (1 and 2)	Connect to HDMI sources.	
②	USB-C IN Port	Connect to a USB-C source. <ul style="list-style-type: none"> This port can receive video, audio and USB 2.0 data. When powered by a Kramer 24V power supply (optional), charges sources (that support USB Power Delivery 2.0) up to 60W. 	
③	LCD Display	Use for device configuration such as setting the AV stream's Ethernet transmission channel.	
④	Menu Navigation Button	◀	Press to return to the previous menu.
		▲	Press to move up to the next configuration parameter.
		▶	Press to go to the next menu.
		▼	Press to move down to the next configuration parameter.
		Enter	Press to accept changes.
⑤	LINK LED	See LED Functionality on page 7.	
⑥	NET LED		
⑦	ON LED		
⑧	24V/5A DC Connector	Connect to the power adapter (purchased separately).	
⑨	RESET Recessed Button	Press and hold for 10 seconds to reset the device to its factory default values. All LEDs flash.	
⑩	LAN MEDIA 1G(PoE) RJ-45 Port	Connect for streaming either directly to a decoder or via LAN. <ul style="list-style-type: none"> Dante: When connected to Dante audio via the network, provides 2 Tx channels and 2 Rx channels. By default, DHCP is enabled on Dante. PoE: KDS-SW3-EN7 is powered by PoE (power over ethernet) delivered through the LAN MEDIA port, unless the optional 24V DC connector is attached. Multicast: Connect to multiple decoders or connect to one decoder to which multiple decoders are daisy-chained via the SERVICE (1G) port. 	

#	Feature	Function
⑪	LAN SERVICE 1G RJ-45 Port	Used optionally for physical separation between AV and command streams to separate LAN for security and reliability purposes.
⑫	RS-232 3-pin Terminal Block Connector	Connect to an RS-232 device to use as a Gateway and bi-directional signal extension (even when no AV signal is extended).
⑬	AUDIO IN/OUT 5-pin Terminal Block Connector	Connect to a balanced analog stereo audio source/acceptor.
⑭	IR 3.5 Mini Jack	Connect to an IR sensor or emitter for bi-directional signal extension (even when no AV signal is extended). Expected voltage for IR receiver - (3.3V).
⑮	USB Type A Charging Ports (1 and 2)	Connect to USB devices, for example, to a speakerphone and webcam.
⑯	HOST USB Type B Port	Connect to a USB host.
⑰	HDMI OUT Connector	Connect to loop the signal.

LED Functionality

KDS-SW3-EN7 LEDs function as follows:

LED	Color	Definition
LINK LED	Lights Green	A link is established between KDS-SW3-EN7 and the decoder is transmitting A/V signals.
	Flashes Green	A signal is established, and a problem is detected.
NET LED	Off	No IP address is acquired.
	Lights Green	A valid IP address has been acquired.
	Flashes Green very fast (for 60sec)	A device identification command is sent (Flag me).
	Lights Yellow	No DHCP IP was assigned, so the device is using the fallback (default) IP address, 192.168.1.39.
ON LED	Flashes Red	The default IP address is unavailable, and the device is acquiring a fallback IP address in subnet 192.168.0.0/16. The ON LED flashes continuously in a slow 0.5/10sec cadence.
	Lights Green	When power is on.
	Flashes Green fast	FW is downloaded in the background.
	Flashes Green very fast (for 60sec)	A device identification command is sent (Flag me).
	Lights Yellow	Device falls back to the default IP address.
Post reboot, all LEDs light for 3 seconds then return to their normal LED display mode.		

Mounting KDS-SW3-EN7

This section provides instructions for mounting **KDS-SW3-EN7**. Before installing, verify that the environment is within the recommended range:



- Operation temperature – 0° to 40°C (32 to 104°F).
- Storage temperature – -40° to +70°C (-40 to +158°F).
- Humidity – 10% to 90%, RHL non-condensing.



Caution:

- Mount **KDS-SW3-EN7** before connecting any cables or power.



Warning:

- Ensure that the environment (e.g., maximum ambient temperature & air flow) is compatible for the device.
- Avoid uneven mechanical loading.
- Appropriate consideration of equipment nameplate ratings should be used for avoiding overloading of the circuits.
- Reliable earthing of rack-mounted equipment should be maintained.
- Maximum mounting height for the device is 2 meters.

Mount KDS-SW3-EN7 in a rack:

Use the recommended rack adapter <https://www1.kramerav.com/product/RK-10MT>.

Mount KDS-SW3-EN7 on a surface using one of the following methods:

- Attach the rubber feet and place the unit on a flat surface.
- Fasten 2 brackets (included) on each side of the unit and attach it to a flat surface.
- For more information see the **Tool bracket installation** instructions in the **Resources** tab at www.kramerav.com/product/KDS-SW3-EN7.

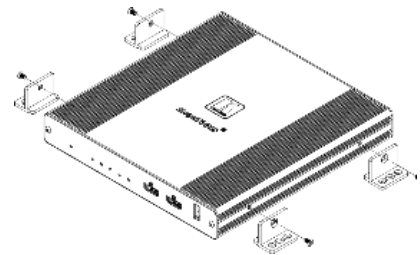

Connecting KDS-SW3-EN7 and KDS-DEC7

i By-default, the device uses PoE for powering the device. Optionally, you can separately purchase a power adapter to connect to the product and plug into the mains electricity.

Always switch off the power to each device before connecting it to your **KDS-SW3-EN7** and **KDS-SW3-EN7**. After connecting your devices, connect their power and then switch on the power to each device.

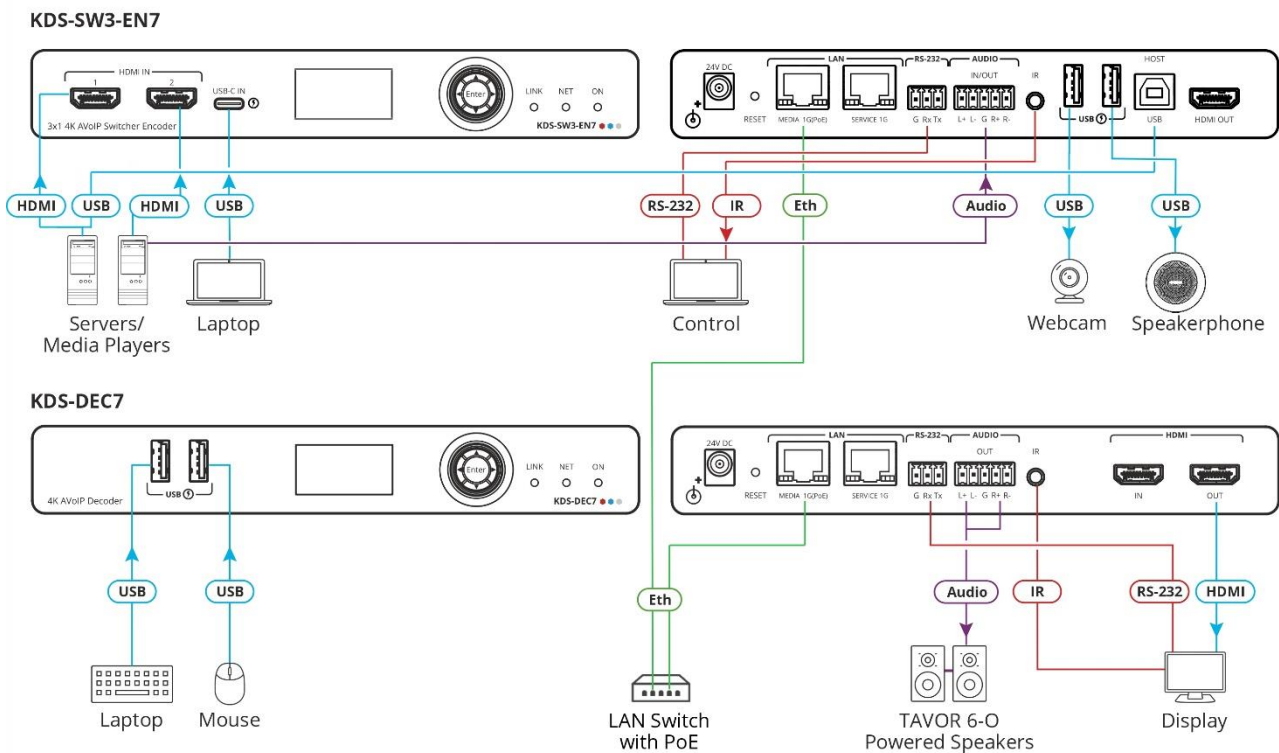

Figure 2: Connecting the KDS-SW3-EN7 and KDS-SW3-EN7

To connect KDS-SW3-EN7 as illustrated in the example in [Figure 2](#):

1. Connect an HDMI source (for example, a server or a media player) to the HDMI IN 1 connector on the **KDS-SW3-EN7** (connector ① in [Figure 1](#)).
2. Connect a video source (for example, a laptop) to the USB IN connector on the **KDS-SW3-EN7** (connector ② in [Figure 1](#)).
3. Connect a balanced stereo audio source (for example, the server audio connector) to the AUDIO IN/OUT 5-pin terminal block connector on the **KDS-SW3-EN7** (connector ⑬ in [Figure 1](#)).
4. Connect the LAN MEDIA 1G(PoE) RJ-45 port (⑨ in [Figure 1](#)) on the **KDS-SW3-EN7** to the LAN MEDIA 1G(PoE) RJ-45 port (⑳ in [Figure 1](#)) on the Kramer **KDS-DEC7** decoder via a LAN switch.
5. Connect the HDMI OUT connector on the **KDS-SW3-EN7** to an HDMI acceptor (for example, a display).

6. Connect the AUDIO OUT 5-pin terminal block connector on the **KDS-SW3-EN7** to a balanced stereo audio acceptor (for example, an audio amplifier).
7. Connect the USB ports:
 - On **KDS-SW3-EN7**, connect the two USB Type A ports ((15) in [Figure 1](#)) to a (for example) webcam and a speakerphone.
 - On **KDS-DEC7**, connect a mouse and a keyboard to the two USB type A ports.
8. Control the display connected to **KDS-SW3-EN7** from the encoder side via IR:
 - On **KDS-SW3-EN7**, connect the IR 3.5mm mini jack ((13) in [Figure 1](#)) to a laptop/controller.
 - On **KDS-DEC7**, connect the IR 3.5mm mini jack to an emitter cable and attach the emitter side to the IR sensor of the display.
9. Connect RS-232 3-pin terminal block connectors:
 - On **KDS-SW3-EN7**, connect the RS-232 port ((11) in [Figure 1](#)) to a laptop/controller.
 - On **KDS-DEC7**, connect RS-232 to the display.



RS-232 bidirectional signals can be sent between the display and the laptop connected to the HDMI OUT connector on the **KDS-SW3-EN7**.

Connecting the Audio Input/Output

The following are the pinouts for connecting the input/output to a balanced or unbalanced stereo audio acceptor:

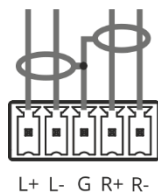

Figure 3: Connecting to a Balanced Stereo Audio Source/Acceptor

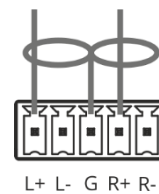

Figure 4: Connecting to an Unbalanced Stereo Audio Acceptor

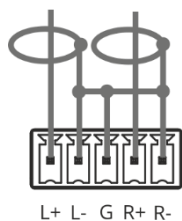

Figure 5: Connecting an Unbalanced Stereo Audio Source to the Balanced Input

Connecting to KDS-SW3-EN7 via RS-232

You can connect to **KDS-SW3-EN7** via an RS-232 connection (12) in [Figure 1](#)) using, for example, a PC.

KDS-SW3-EN7 features an RS-232 3-pin terminal block connector allowing the RS-232 to control **KDS-SW3-EN7**.

Connect the RS-232 terminal block on the rear panel of **KDS-SW3-EN7** to a PC/controller, as follows:

From the RS-232 9-pin D-sub serial port connect:

- Pin 2 to the TX pin on the **KDS-SW3-EN7** RS-232 terminal block
- Pin 3 to the RX pin on the **KDS-SW3-EN7** RS-232 terminal block
- Pin 5 to the G pin on the **KDS-SW3-EN7** RS-232 terminal block

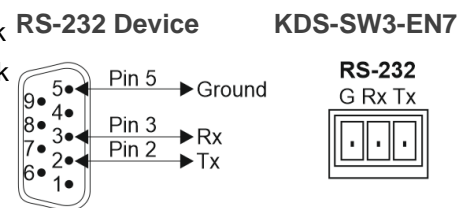

Connecting to KDS-SW3-EN7 via Ethernet

You can connect to **KDS-SW3-EN7** via Ethernet using either of the following methods:

Connect to the PC using a crossover cable, see [Connecting the Ethernet Port to a PC](#) on page [12](#).

Connect to a network hub, switch, or router, using a straight-through cable; see [Connecting the Ethernet Port via a Network Hub or Switch](#) on page [11](#).



If you want to connect via a router and your IT system is based on IPv6, speak to your IT department for specific installation instructions.

Connecting the Ethernet Port via a Network Hub or Switch

Connect the Ethernet port of **KDS-SW3-EN7** to the Ethernet port on a network hub or using a straight-through cable with RJ-45 connectors.

Before setting the system, make sure that your AV over IP network switch meets the following minimum requirements:

- Jumbo Frames – On. (at least 8000 bytes).
- IGMP Snooping – On.
- IGMP Querier – On.
- IGMP Immediate/Fast Leave – On.
- Unregistered Multicast Filtering – On.

Connecting the Ethernet Port to a PC

Connect the LAN Media (Ethernet) port of **KDS-SW3-EN7** directly to the Ethernet port on your PC using a crossover cable with RJ-45 connectors.



This type of connection is recommended for identifying the **KDS-SW3-EN7** with the factory configured default IP address.

If you connect through an installation-wide LAN, the DHCP will automatically allocate an IP address to the device, which you will need to identify.

After connecting **KDS-SW3-EN7** to the Ethernet port, configure your PC as follows:

1. Click **Start > Settings > Network & Internet**.
2. In the **Advanced network settings**, click **Change adapter options**.
3. Highlight the network adapter you want to use to connect to the device and click **Change settings of this connection**.

The Local Area Connection Properties window for the selected network adapter appears as shown below:

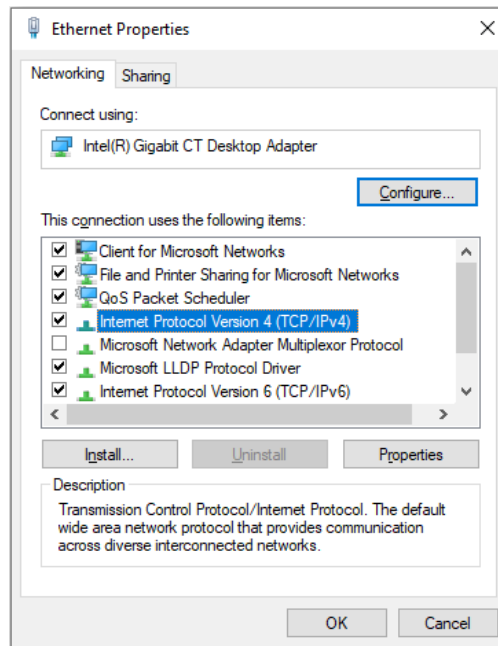

Figure 6: Local Area Connection Properties Window

4. Highlight **Internet Protocol Version 4 (TCP/IPv4)** or **Internet Protocol Version 6 (TCP/IPv6)** if your system uses it.
5. Click **Properties**.

The Internet Protocol Properties window relevant to your IT system appears.

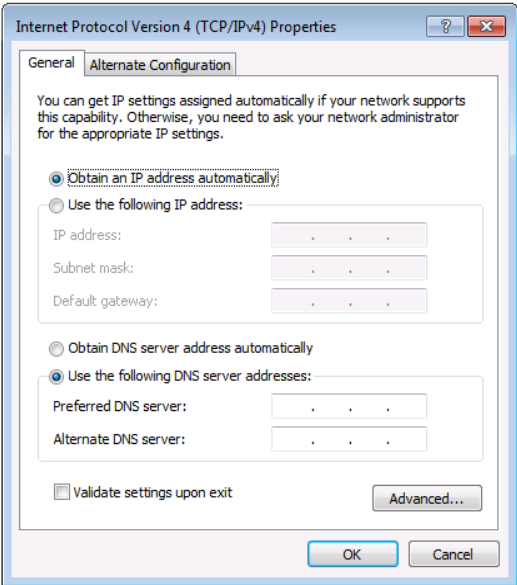

Figure 7: Internet Protocol Version 4 Properties Window

- 6. Select **Use the following IP Address** for static IP addressing and fill in the details as shown below. You can use any IP address in the range 192.168.1.1 to 192.168.1.255 (excluding 192.168.1.39) that is provided by your IT department.

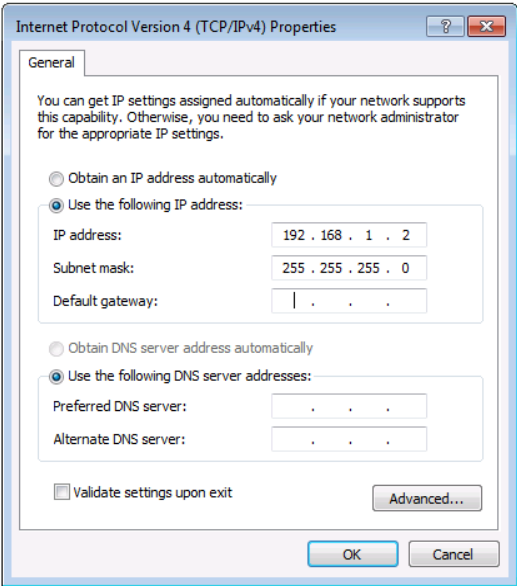

Figure 8: Internet Protocol Properties Window

- 7. Click **OK**.
- 8. Click **Close**.

Fast switching configuration

When fast switching is configured, you can easily switch decoders between different encoders on different channels.

To set fast switching:

1. Access the encoder and decoder web pages.
2. In the Main > AV Routing page, set a unique Channel ID and Channel Name.

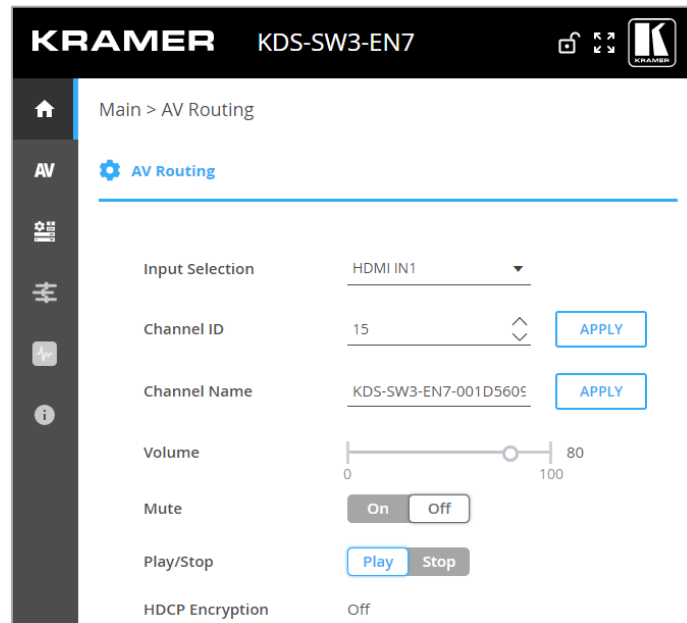

Figure 9: Setting Channel ID and Name on the **KDS-SW3-EN7**

3. If there are other encoders in the system, they should share the same HDCP setting and resolution rate. For example, to configure fast switching between encoder 1 and encoder 2 the following settings need to be identical on the input source:
 - HDCP setting.
 - Resolution and Refresh rate.
4. On the decoders, set the Maximum Resolution in the AV Settings>Video page to be identical to the encoder.

Fast switching is configured.

Operating and Controlling from the Front Panel

- [Using the Menu Navigation Button](#) on page [15](#).
- [Using the LCD Display Menu](#) on page [16](#).
- [Identifying the IP Address](#) on page [16](#).
- [Setting the Channel Number](#) on page [17](#).
- [Setting the Input Port](#) on page [17](#).
- [Viewing Version Information](#) on page [17](#).
- [Selecting the EDID](#) on page [18](#).
- [Defining HDCP Settings](#) on page [18](#).

Using the Menu Navigation Button

Use the navigation button to easily view and set basic device parameters via the LCD display menu (② in [Figure 1](#))

Use the Navigation buttons (③ in [Figure 1](#)):

- Up arrow – Move to the previous configuration parameter.
- Down arrow – Move to the next configuration parameter.
- Left arrow – Return to the previous menu.
- Right arrow – Go to the next menu.
- Enter button – Accept and save the change.

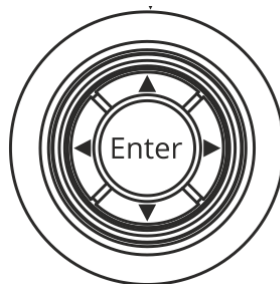

Figure 10: Navigation button

Using the LCD Display Menu

To access the LCD display menu, press **Enter**: The Main Menu is displayed.

The **Main Menu** has 3 sub-menus (listed below). Only the **Dev Settings** entries are editable.

Main Menu Items	Sub-menu Options	Output
1. Dev Status	LAN 1 Status	Displays the IP address of the KDS-SW3-EN7 MEDIA port.
	LAN 2 Status	Displays the IP address of the KDS-SW3-EN7 SERVICE port.
	INPUT Status	Displays the resolution and HDCP status of the active input connection (HDMI 1, HDMI 2, or USB-C).
	CH Define	Channel number of the output stream.
	Temperature	Device temperature in centigrade.
2. Info		Firmware version, build version and hardware version.
3. Dev Settings	INPUT	Lists the available inputs (HDMI 1, HDMI 2 and USB-C). An asterisk (*) indicates the active input: Use "Enter" to change the setting. If no input is detected on selected input, auto-switching will be applied, see Defining Auto Switching on page 22.
	EDID	Lists the stored EDIDs (maximum 8). An asterisk (*) indicates the active EDID. Use "Enter" to change the setting. To change the EDID list see Managing EDID on page 27.
	HDCP	Shows if HDCP is active on the HDMI or USB-C input. An asterisk (*) indicates that HDCP is active: Use "Enter" to change the setting (see also Defining HDCP Settings on page 18).
	CH Select	Shows channel Id of the output stream, enter a different channel number using the up/down arrows on each numeral in the number (see also Setting the Channel Number on page 17).

Identifying the IP Address

KDS-SW3-EN7 IP default static addresses is: 192.168.1.39. If a DHCP server allocates the address, you may need to identify it.

To identify the actual IP address:

1. Press **Enter** on the navigation button to open the Main Menu.
2. Press **Enter** to open the **Dev Status** menu.
3. Use the Up/Down arrows to select **LAN1**.

The IP address is displayed.

Setting the Channel Number

Each encoder requires a unique channel number, and the connected decoders should be tuned to that encoder channel. You can set the channel number via the LCD screen menu or the embedded web pages.

To set the channel number for KDS-SW3-EN7, via LCD screen menu:

1. Press **Enter** on the navigation button to open the Main Menu.
2. Press **Enter** to open the **DEV SETTINGS** menu.
3. Use the Up/Down arrows to select **CH DEFINE**.
4. Use the Up/Down arrows to change the channel number (set a unique channel number).
5. Press **Enter** to save your selection.

The channel number is set.

Setting the Input Port

To select the Input Port (HDMI 1, HDMI 2 or USB-C):

1. Press **Enter** on the navigation button to open the **Main Menu**.
2. Use the up/down arrows to select the **Dev Settings** menu, and press **Enter**.
3. Use the Up/Down arrows to select **Input**.

The available input ports are listed, with an asterisk next to the active input source.

4. Use the up/down arrows to select the input you want, and press **Enter**: The asterisk will be placed next to it.

The input port has been set.

Viewing Version Information

To view device parameters:

1. Press **Enter** on the navigation button to open the **Main Menu**.
2. Use the up/down arrows to select **Info**.
3. Press the up or down arrows to view the device firmware and hardware information:
 - Firmware version (FW).
 - Bootloader information (BL).
 - Hardware version (HW).

Device version information is viewed.

Selecting the EDID

To select the EDID:

1. Press **Enter** on the navigation button to open the **Main Menu**.
2. Use the up/down arrows to select the **Dev Settings** menu, and press **Enter**.
3. Use the Up/Down arrows to select **EDID**.

The active EDID will be shown with an asterisk next to it.

4. To change the EDID, move up or down through the list and stop on the desired EDID.
5. Press **Enter** to accept change.

EDID on the input is set.

Defining HDCP Settings

Enable or disable HDCP on the input via the navigation buttons.

To define HDCP settings:

1. Press Enter on the navigation button to open the **Main Menu**.
2. Use the up/down arrows to select the **Dev Settings** menu, and press **Enter**.
3. Use the Up/Down arrows to select **HDCP**.

If HDCP is active on HDMI or USB-C, it will have an asterisk next to it.

Use the arrow keys to activate HDCP on another input type.

4. Press **Enter** to accept the **HDCP** mode.

HDCP on the input is set.

Operating and Controlling from the Embedded Web Pages

KDS-SW3-EN7 enables you to operate and control the device via Ethernet using built-in, user-friendly web pages.

KDS-SW3-EN7 embedded web pages enable you to do the following:

- [Opening the Embedded Web Pages](#) on page [20](#).
- [Defining AV Routing Parameters](#) on page [21](#).
- [Defining Auto Switching](#) on page [22](#).
- [Defining Signal Loss Timeouts](#) on page [23](#).
- [Defining HDMI Input Settings](#) on page [24](#).
- [Defining Audio Settings](#) on page [25](#).
- [Defining Dante Audio as a Source or Destination](#) on page [26](#).
- [Managing EDID](#) on page [27](#).
- [General Device Settings](#) on page [29](#).
- [KDS-SW3-EN7 Network Settings](#) on page [33](#).
- [Defining KDS-SW3-EN7 Time and Date](#) on page [36](#).
- [Setting KDS-SW3-EN7 Security](#) on page [37](#).
- [Defining KDS-SW3-EN7 User Access](#) on page [40](#).
- [Defining KDS-SW3-EN7 Gateway Settings](#) on page [43](#).
- [Viewing KDS-SW3-EN7 Status](#) on page [46](#).
- [Viewing KDS-SW3-EN7 Connections Status](#) on page [47](#).
- [Viewing KDS-SW3-EN7 Advanced Status](#) on page [48](#).
- [Viewing the About Page](#) on page [49](#).

Opening the Embedded Web Pages



If an embedded web page does not update correctly, clear your Web browser's cache.

To browse the KDS-SW3-EN7 embedded web pages:

1. Find the IP address of the **KDS-SW3-EN7**. The default IP (when connected directly to a computer) is 192.168.1.39, see also [Identifying the IP Address](#) on page 16 if a DHCP server defines the address.
2. Type the IP address of **KDS-SW3-EN7** in the address bar of your internet browser.

The **Login** window appears:

The login window is titled "Login" and contains two input fields: "Username" and "Password". Below the fields is a blue "Sign In" button.

Figure 11: Login Window

3. Enter the **Username** and **Password** (admin/admin, by default). The **KDS-SW3-EN7** page appears.

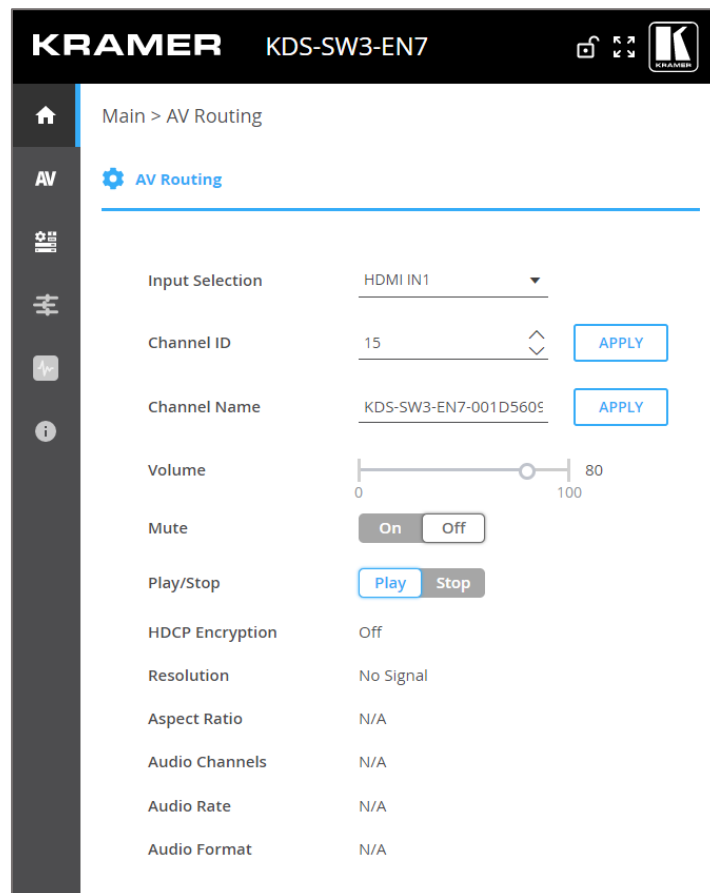

Figure 12: Embedded web pages – Home page

4. Click the tabs on the left side of the screen to access the relevant web page.

Defining AV Routing Parameters

Set the KDS-SW3-EN7 AV routing parameters.

To set AV routing parameters:

1. In the Navigation pane, Select **Main>AV Routing**. The AV Routing page appears (see [Figure 12](#)).
2. Select an input from the **Input Selection** drop-down box (HDMI IN1, HDMI IN2 or USB IN3).
3. Define the following settings:
 - **Channel ID:** Set Channel ID and click **APPLY**.
Channel ID defines the device input ID (1 to 999).
 - **Channel Name:** Enter the Stream Name and click **APPLY**.
Channel name is identical to Host name (see [General Device Settings](#) on page [29](#)), can include up to 24 characters; “-“ and “_” are allowed within the name.
By default, the name is the model name and MAC address connected by “-”.
 - **Volume:** Use the slider to adjust the analog audio output volume (0 to 100%).
Default is 80 (0dB), 100% (12dB) and 0 is mute.
 - **Mute:** Mute/unmute all audio outputs (HDMI out, Analog audio out, Dante out and MEDIA port).
 - **Play/Stop:** Start or stop streaming of video, audio, IR, RS-232 and USB signals.
4. View the following streaming parameters: HDCP Encryption, Resolution, Aspect Ratio, Audio Channels, Audio Rate and Audio Format.

Routing parameters are defined.

Defining Auto Switching

Set **KDS-SW3-EN7** auto switching to one of three configurations:

- **Last Connected** (default) – When a video source input is detected, the device switches to that latest connected video source to the output.
When the selected video source is disconnected, the device switches to the other video source automatically.
- **Priority** – When more than one of HDMI IN 1, HDMI IN 2 and USB IN 3 are connected to video sources, after the device is powered on, the input port with higher priority is selected.
When the selected video source is disconnected, the device switches to the other (lower priority) video source automatically.
- **Manual** – The input is selected manually.

To define input auto switching settings:

1. In the Navigation pane, Select **AV**. The **Auto Switch** tab in the AV Routing page appears:

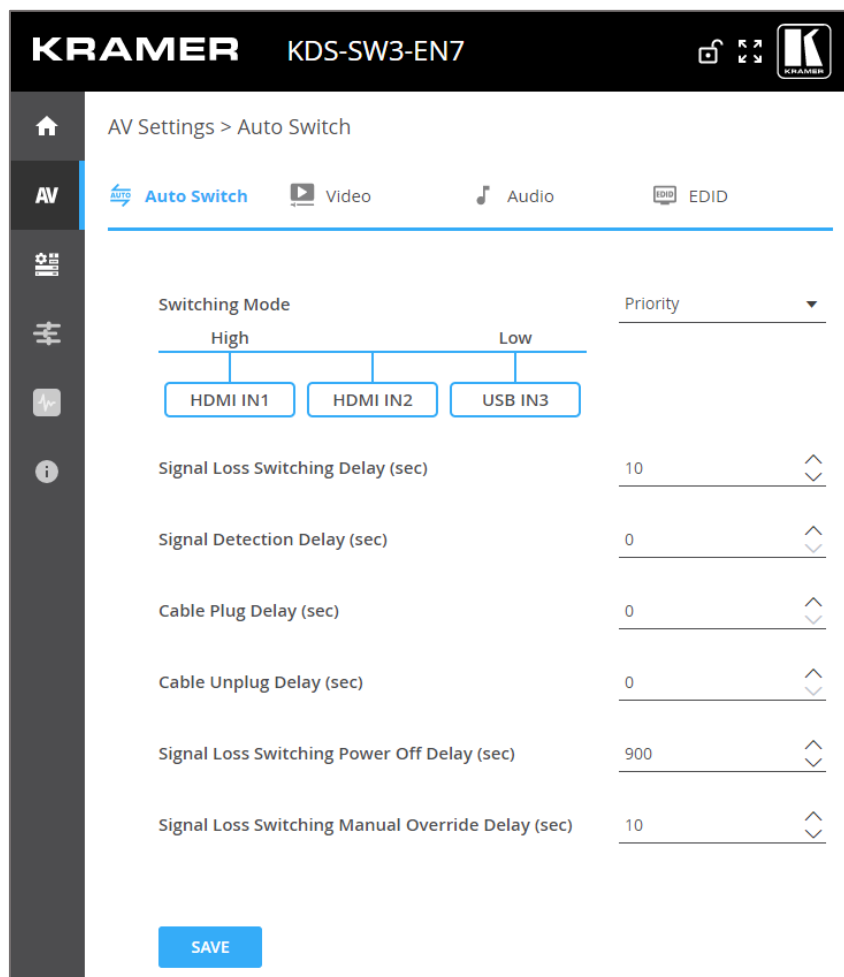

Figure 13: AV Settings Page – Auto Switch Tab

2. Next to Switching mode, open the drop-down mode to select the switching mode:
 - **Last Connected** (default), auto switching is set to Last Connected.
 - **Priority** – Set the input priorities by holding and dragging an input to high or low/ the input with the high priority is switched first.
In the following example, USB IN3 is dragged to the **High** priority location and replaces HDMI IN1 which moves to the **Low** priority location.

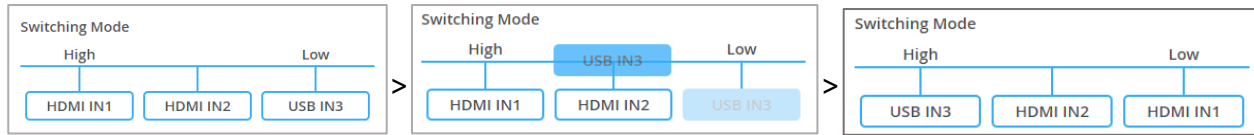

Figure 14: Setting Priority Auto Switching

- **Manual** – Select the input manually via front panel menu button (see [Setting the Input Port](#) on page 17) or the embedded web pages (see [Defining AV Routing Parameters](#) on page 21).



After changing the switching mode, if you need to reboot the device, wait at least 30 seconds before doing so. Switching mode settings will be lost if device is rebooted within 30 seconds of the change.

Auto Switching mode is set.

Defining Signal Loss Timeouts

KDS-SW3-EN7 enables setting timeouts if a signal is lost or a cable is disconnected.

To define signal loss timeouts:

1. In the Navigation pane, Select **AV**. The Auto Switch tab in the AV Settings page appears (see [Figure 13](#)).
2. Set the following timeouts (in seconds):
 - **Signal Loss Switching Delay** – From the time KDS-SW3-EN7 detects a signal loss, to when it switches to a different input (default 10).
 - **Signal Detection Delay** – From the time KDS-SW3-EN7 detects a signal, to when it switches to that input (default 0).
 - **Cable Plug Delay** – From the time KDS-SW3-EN7 detects a cable connected, to when it switches to that input (default 0).
 - **Cable Unplug Delay** – From the time KDS-SW3-EN7 detects a disconnected cable to when it switches to a different input (default 0).
 - **Signal Loss Switching Power Off Delay** – From the time KDS-SW3-EN7 detects a signal loss to when the 5V power output turns off (default 900).
 - **Signal Loss Switching Manual Override Delay** – From when KDS-SW3-EN7 detects a signal loss on manual override to when it switches to a different input (default 10).
3. Click **SAVE**.
Signal loss timeouts are defined.

Defining HDMI Input Settings

Define KDS-SW3-EN7 video settings.

To define HDMI input settings:

1. In the Navigation pane, Select **AV**. The Auto Switch tab in the AV Routing page appears (see [Figure 13](#)).

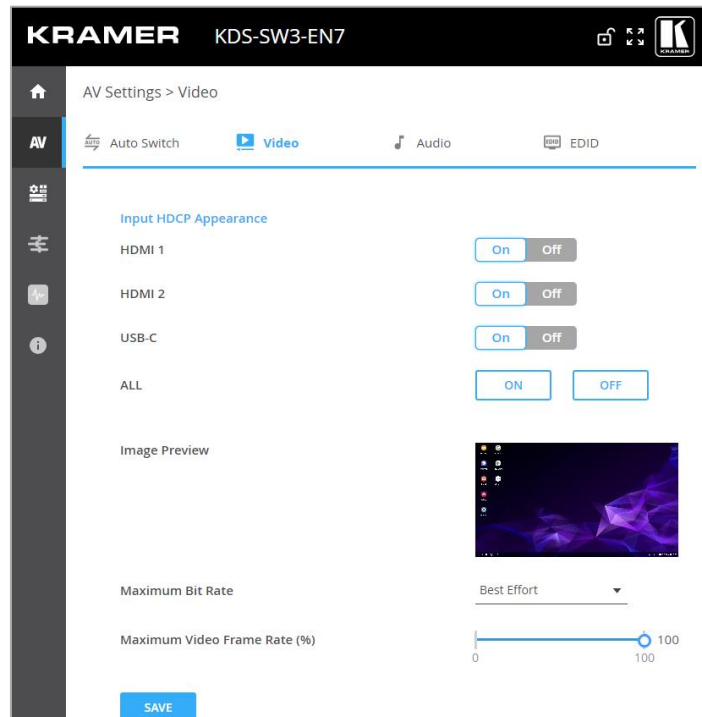

Figure 15: AV Settings Page – Video Tab

2. Define the following settings:

- **Input HDCP Appearance:** Enable (**ON**)/disable (**OFF**) HDCP support for each input.



When HDCP is turned off, a non-HDCP input source can be routed to the output (for example, in Apple devices).

- **Image Preview:** Preview the output video being streamed.
- **Maximum Bit Rate:** select the maximum transmission bandwidth. Select bandwidth (10Mbps, 50Mbps, 100Mbps, 150Mbps and 200Mbps) or Best Effort (default) to set bandwidth for best video quality output, allowing the peak bandwidth to reach 850Mbps.



After setting the maximum bit rate you need to restart the device.

- **Maximum Video Frame Rate (%):** use the slider to configure the maximum frame rate in proportion. 100% (default) means zero compression on the frame rate.

3. Click **SAVE**.

HDMI input settings are defined.

Defining Audio Settings

Define KDS-SW3-EN7 audio settings.



- Where there is a choice between HDMI and USB-C, the system will automatically apply the active video input source.
- Dante audio is always received or transmitted over IP (LAN). See [Defining Dante Audio as a Source or Destination](#) on page 26.
- Dante audio can only be implemented in manual **Audio Source Mode**.

To define Audio settings:

1. In the Navigation pane, Select **AV**. The **AV Settings > Auto Switch** tab appears.
2. Select the **Audio** tab. The Audio tab appears.

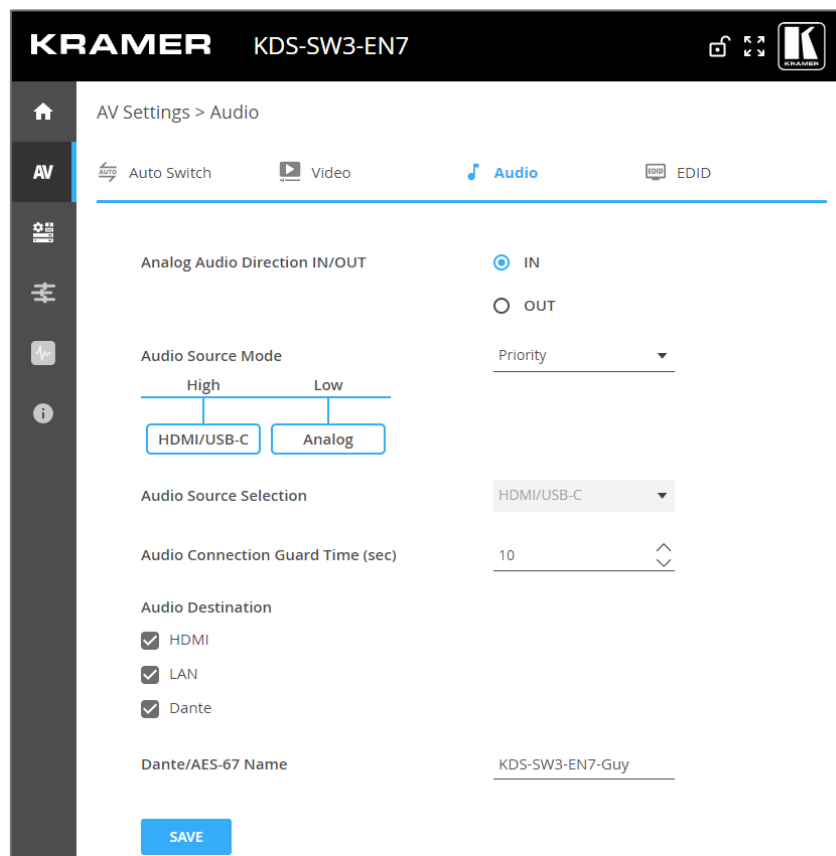

Figure 16: AV Settings Page – Audio Tab

3. Select **IN** or **OUT** as the **Analog Audio Direction**. This sets the direction that will be applied to the analog audio port ⁽¹³⁾, if it is being used.
4. Set the **Audio Source Mode**:
 - **Last Connected** – The last used audio source will be sent to the audio output destinations. If the audio source was analog and no signal is detected within the time frame set in the **Audio Connection Guard Time** field, the system will switch to the video source (HDMI/USB-C).
 - **Manual** – The **Audio Source Selection** field defines the source for the audio.

- **Priority** – The audio source is selected from **HDMI/USB-C** or **Analog**, in the order of priority that you set. Set the priority by clicking and dragging an input. **High** priority is tried first, **Low** priority will be used if no signal is detected from the high priority, within the time frame set in the **Audio Connection Guard Time** field.
 - **Dante** is not available as an option in Priority mode.
5. Set the **Audio Source Selection**, this option is only available if **Audio Source Mode** is set to **Manual**. Choose between HDMI/USB-C, Analog, None and Dante.
 - Dante is always received over IP (from the LAN). See [Defining Dante Audio as a Source or Destination](#) on page 26.
 6. Set the **Audio Connection Guard Time** (10 seconds, by default), which is the audio signal loss time interval.
For example, in **Last Connected** or **Priority** mode, if the analog audio signal is lost for 10 seconds (either becomes silent or is unplugged), the HDMI/USB-C source is automatically selected.
 7. Set the **Audio Destination** (multiple options are available):
 - **HDMI** – Audio is transmitted to the **KDS-SW3-EN7** HDMI output port ⁽¹⁷⁾.
 - **Analog** – Only available if the **Analog Audio Direction** field is set to **OUT**.
 - **LAN** – Audio is transmitted with the **KDS-SW3-EN7** output stream.
 - **Dante** – Audio is transmitted over the LAN, identifiable by the **KDS-SW3-EN7** IP and the Dante Name assigned to it. For more information see [Defining Dante Audio as a Source or Destination](#) on page 26.
 8. If you are using Dante for audio input or output, enter the **Dante Name**, the Dante hostname which will identify the audio source in the Dante software (see [KDS-SW3-EN7 Network Settings](#) on page 33).
 9. Click **SAVE**.
- Audio settings are defined.

Defining Dante Audio as a Source or Destination

Dante is a professional audio over Ethernet technology and is designed for transmission of multiple audio channels over relatively long distances or to many locations.

Note: KDS-SW3-EN7 doesn't support AES-67.

To use Dante audio with the **KDS-SW3-EN7**:

1. Download and install the **Dante Controller** software from <https://my.audinate.com/support/downloads/dante-controller>.
2. Set the audio source or destination to **Dante** in the (**KDS-SW3-EN7** webpages) **AV Settings** page, **Audio** tab (see [Defining Audio Settings](#) on page 25).
3. Activate Dante transmission from the Service or Media port in the (**KDS-SW3-EN7** webpages) **Device Settings** page, **Network** tab (see [Using the Service Port for Dante, P3K & Gateway transmissions](#) on page 33).

- Use the **Dante Controller** software to route the audio between the **KDS-SW3-EN7** and the Dante source or destination.

Dante has been defined.

Managing EDID

EDID (extended display identification data) is metadata **KDS-SW3-EN7** receives from the display device. It describes the displays capabilities and is used to format the video for output.



- **KDS-SW3-EN7** can store up to 8 EDIDs. EDIDs can be added or removed.
- There is a default EDID called **default.bin** which cannot be deleted.
- The default EDID list is restored after a factory reset.

You can select or upload an EDID and lock it (make it the permanent EDID), if required.

To manage EDID:

- In the Navigation pane, Select **AV** and then the **EDID** tab.
The EDID Management tab appears:

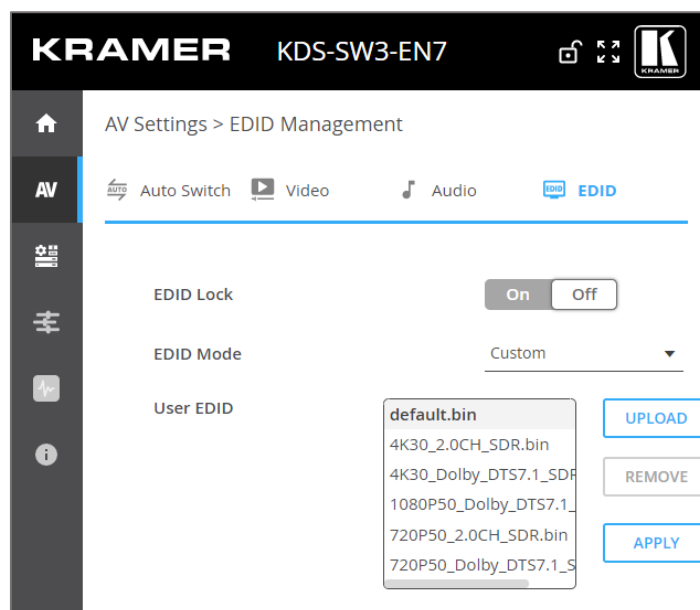

Figure 17: AV Settings Page – EDID Management Tab

- Set EDID Lock:
 - **ON** - Locks the last acquired EDID.
 - **OFF** - Unlock and acquire a new EDID.

3. In the **EDID Mode** field, select Passthrough, Custom or Default EDID:
- **Default EDID** – Use the default built-in EDID.
 - **Passthrough** – Acquire the EDID from a specific decoder and copy it to **KDS-SW3-EN7**:
 - a. Enter the decoder IP address.
 - b. Click **READ**.
 - c. The EDID is copied from the decoder to the encoder.
 - **Custom** – Use a saved EDID or upload a new EDID file from an external source. Up to 8 EDID files can be stored (remove some if you need more space).
 - a. To apply a saved EDID - Select an EDID from the list and click **APPLY**.
 - b. To remove a saved EDID - Select it and click **REMOVE**.
 - c. To save an EDID file - Click **UPLOAD** and select an EDID file to upload. The EDID file is added to the list.

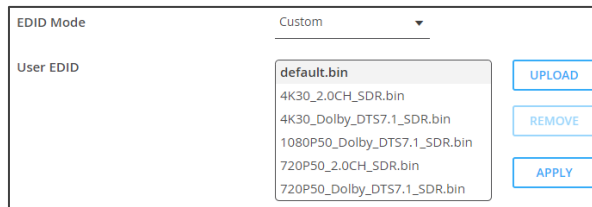

Figure 18: The saved EDID List

EDID is managed.

General Device Settings

Change the Host Name, which is identical to the Channel ID name (see [Defining AV Routing Parameters](#) on page 21), view the device model, H/W release version, serial number and MAC address.

The DNS name on Windows OS must be within 10 characters in length and cannot include numbers only.



Though the device has only one MAC address, you can configure up to two separate IP addresses for the two Ethernet ports in two subnets using one MAC address (see [KDS-SW3-EN7 Network Settings](#) on page 33).

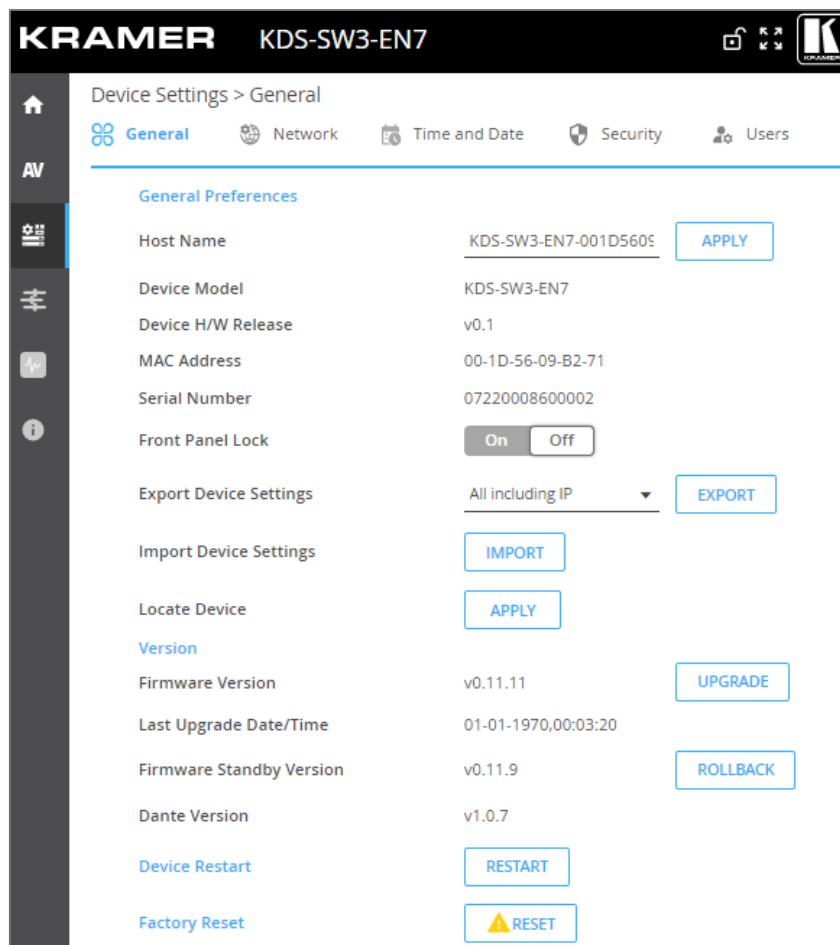

Figure 19: Device Settings – General Tab

KDS-SW3-EN7 enables performing the following actions via the General Settings tab:

- [Locking/Unlocking the Front Panel](#) on page 30.
- [Importing/Exporting Device Settings](#) on page 31.
- [Locating the Device](#) on page 32.
- [Managing the Firmware Version](#) on page 32.
- [Restarting or Resetting the Device](#) on page 32.

Locking/Unlocking the Front Panel

To lock/unlock the front panel:

1. In the Navigation pane, Select **Device Settings**. The General tab in the Device Settings page appears.
2. Lock/Unlock the device's front panel using the **Front Panel Lock** field, in the **General Preferences** field group:
 - Click **On**, to lock the front panel buttons and disable device control via the navigation buttons.
 - Click **Off**, to unlock the front panel buttons and enable device control from the front panel via the LCD screen and the navigation buttons(see [Using the Menu Navigation Button](#) on page 15).

Front panel buttons are locked/unlocked.

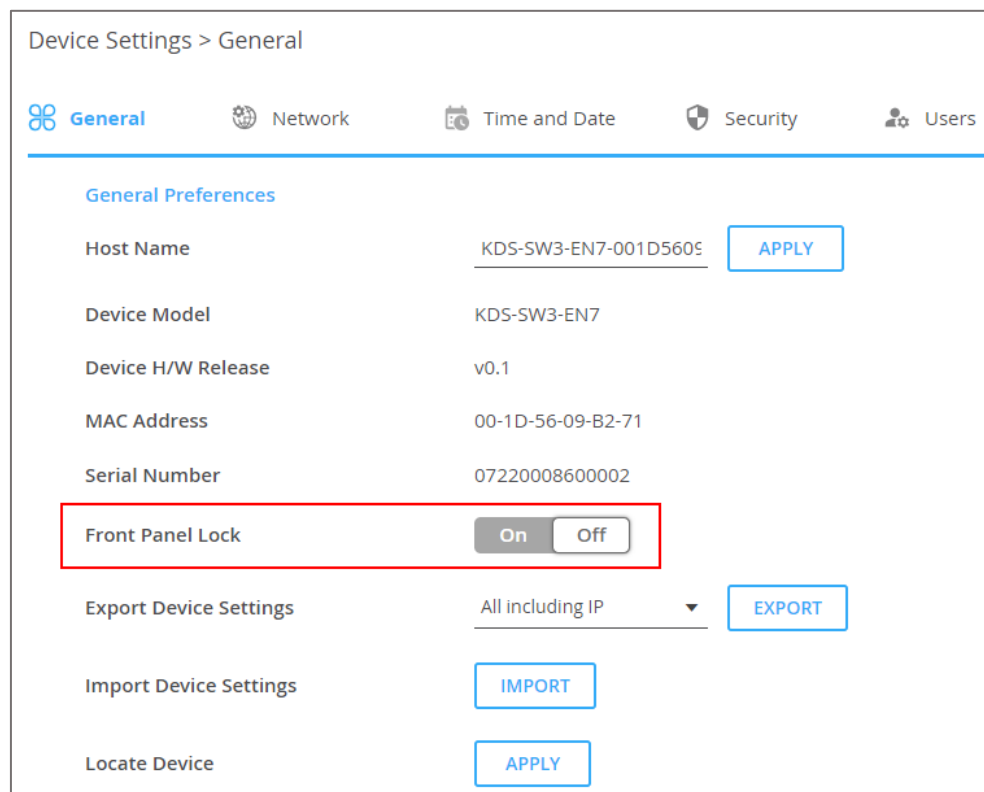

Figure 20: Front Panel Lock

Importing/Exporting Device Settings

Import or export device settings from/to the device. Settings are stored in JSON format, inside a tar.gz file. To understand how to structure the data, export the settings and use the output file as a model.

To import or export the device settings:

1. In the Navigation pane, Select **Device Settings**. The General tab in the Device Settings page appears (see [Figure 19](#)).
2. In the **Import/Export Device Settings** field, select the setting types to import or export:
 - **All without IP** – All the settings, excluding the IP address.
 - **Streams** – Video, audio, IR, CEC and RS-232 settings.
 - **AV Settings Only** – Auto Switching, EDID, video, and audio settings.
 - **All including IP** – All settings, including the IP address.
3. To import settings:
 - Click **IMPORT**.
 - Select the file to import (settings.tar.gz).
 - Click **Open** to import the file.
4. To export settings, click **EXPORT**.
The settings file is created (settings.tar.gz).

The settings file is imported/exported.

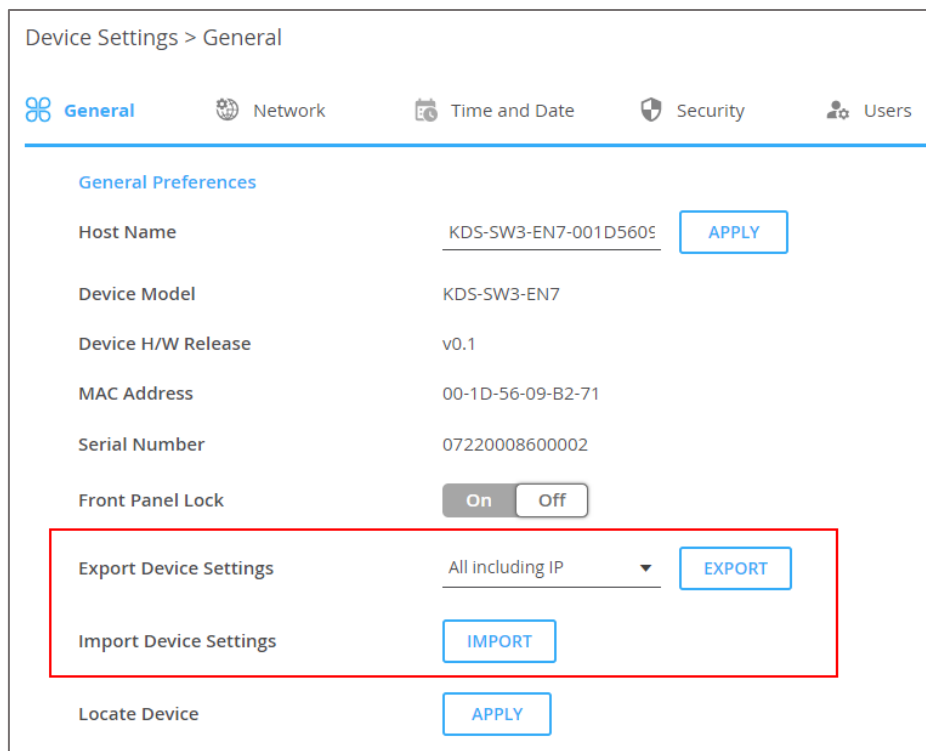

Figure 21: Import/Export Device Settings

Locating the Device

To locate the device:

1. In the Navigation pane, Select **Device Settings**. The General tab in the Device Settings page appears (see [Figure 19](#)).
2. In the General Device Settings page, click **APPLY** next to Locate Device. the located device NET and ON LEDs on the front panel flashes for 60 seconds.

The device is located in the system.

The screenshot shows the 'General' tab of the device settings. The 'Locate Device' button is highlighted with a red rectangular box. Other visible settings include Host Name (KDS-SW3-EN7-001D5605), Device Model (KDS-SW3-EN7), Device H/W Release (v0.1), MAC Address (00-1D-56-09-B2-71), Serial Number (07220008600002), Front Panel Lock (On/Off toggle), Export Device Settings (All including IP), and Import Device Settings (IMPORT button).

Figure 22: Locate Device

Managing the Firmware Version

To upgrade the firmware, view the date of the last upgrade, or rollback to the previous firmware revision in case of a problem, see [Upgrading Firmware](#) on page [50](#).



Click **ROLLBACK** to update to the previous FW version.

Restarting or Resetting the Device

Click **RESTART** to reboot the device, click **RESET** to restore device factory default settings.

The screenshot shows the 'Version' section of the device settings. The 'UPGRADE', 'ROLLBACK', 'RESTART', and 'RESET' buttons are highlighted with a red rectangular box. Other visible settings include Firmware Version (v0.11.11), Last Upgrade Date/Time (01-01-1970,00:03:20), Firmware Standby Version (v0.11.9), and Dante Version (v1.0.7).

Figure 23: Update Firmware

KDS-SW3-EN7 Network Settings

The  **Device Settings** page, **Network Settings** tab controls the Ethernet port and IP settings of the KDS-SW3-EN7 and provides the following capabilities:

- [Using the Service Port for Dante, P3K & Gateway transmissions](#) on page 33.

Using the Service Port for Dante, P3K & Gateway transmissions

KDS-SW3-EN7 has two Ethernet ports (SERVICE 1G and MEDIA 1G).

- **MEDIA** port ⁽¹⁰⁾ - By default, all network connections use the Media port with DHCP enabled and 802.1Q disabled. Video and other types of streaming always use the **MEDIA** port.
- **SERVICE** port ⁽¹¹⁾ - The Service port is optional. It has a separate IP address and can be used for **Protocol 3000** commands, **Gateway** traffic and/or **Dante audio** streaming.

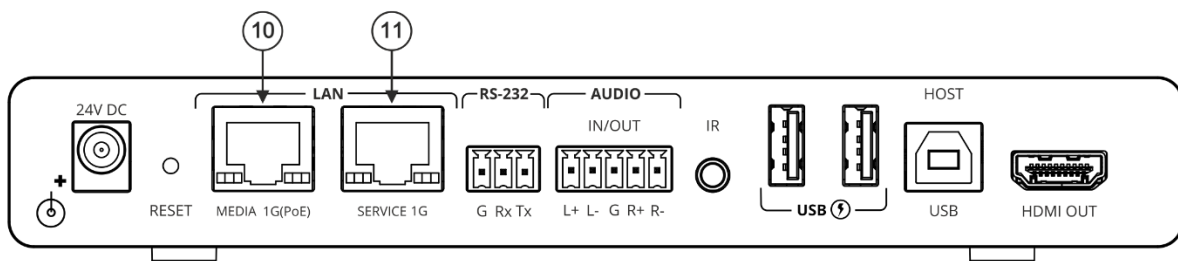

Figure 24: Ethernet ports on the rear of the KDS-SW3-EN7

Service Name	Port	802.1Q	VLAN Tag	DHCP	IP Address	Mask Address	Gateway Address
Stream	Media	N/A	N/A	<input checked="" type="checkbox"/> On <input type="checkbox"/> Off	192.168.1.39	255.255.0.0	0.0.0.0
P3K & Gateway	Media	<input checked="" type="checkbox"/> On <input type="checkbox"/> Off	2	<input checked="" type="checkbox"/> On <input type="checkbox"/> Off	192.168.1.39	255.255.0.0	0.0.0.0
Dante	Media	<input checked="" type="checkbox"/> On <input type="checkbox"/> Off	2	<input checked="" type="checkbox"/> On <input type="checkbox"/> Off	169.254.7.20	255.255.0.0	0.0.0.0

Figure 25: Device Settings Page – Network Tab

To separate P3K & Gateway from the AV streams

1. Change the following settings in the **Interface Settings** section of the **Network** tab (see [Figure 25](#)):
 - In the **P3K & Gateway** row's **Port** column select **Service** and set **802.1Q** to **On**.
 - In the **VLAN ID** column, enter an integer number (2 - 4093) for P3K & Gateway services. This separates the P3K & Gateway packets.



802.1Q and VLAN are not required for the Media port.

2. To use a static IP for the SERVICE port, set DHCP to **Off** and enter a subnet mask and gateway address. If no static IP is defined, the DHCP server will allocate the IP.

If no DHCP server exists in the system, the device will look for a random unique IP in the range of 169.254.X.Y. The allocated IP address is shown in the IP address field.

To separate Dante Audio from the AV streams:

1. In the **Dante** row's **Port** column select **Service** and set **802.1Q** to **On**.
 - In the **VLAN ID** column, enter an integer number (2 - 4093) for Dante services. Make sure this is different from the number used for the P3K & Gateway packets.



802.1Q and VLAN are not required for the Media port.

2. To use a static IP for the SERVICE port, set DHCP to **Off** and enter a subnet mask and gateway address. If no static IP is defined, the DHCP server will allocate the IP.

Defining IP Casting Mode Setting and TTL

The **IP Casting Mode** is set by the Encoder. The setting on this field needs to be the same as that on the encoder:

- **Unicast** – The encoded stream is intended for a specific decoder.
- **Multicast** (default) – Any decoder can access the encoded stream.
- **TTL** (time to live) limits the lifetime of the streamed data in the computer network. It prevents the IP packet from propagating endlessly through the network. The default value is 64, which means that after 64 hops the data packet is dropped.

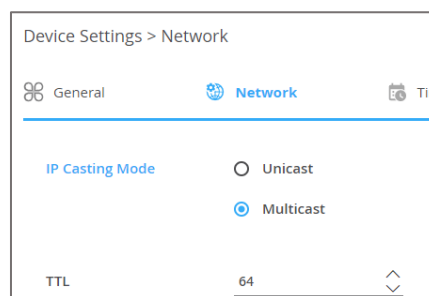

Figure 26: Network Settings – IP Casting Mode

Managing TCP/UDP Ports

TCP and UDP are protocols that define how data is streamed. The port on which the data is received must be defined in the system.

To manage TCP and UDP ports:

Open the  **Device Settings** page, **Network** tab:

The default values are **TCP Port** - 5000 and **UDP Port** - 50000.

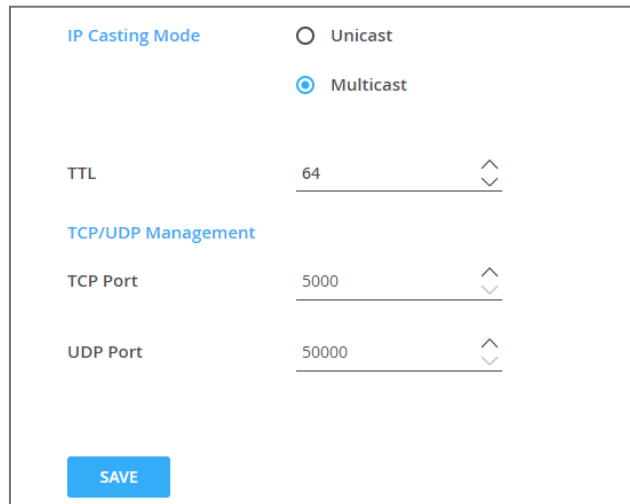

The screenshot displays the 'Device Settings' page, specifically the 'Network' tab. It features the following settings:

- IP Casting Mode:** Two radio buttons are present. 'Unicast' is unselected, and 'Multicast' is selected (indicated by a blue dot).
- TTL:** A text input field contains the value '64', with up and down arrow icons to its right.
- TCP/UDP Management:** A section header in blue text.
- TCP Port:** A text input field contains the value '5000', with up and down arrow icons to its right.
- UDP Port:** A text input field contains the value '50000', with up and down arrow icons to its right.
- SAVE:** A blue rectangular button is located at the bottom left of the settings area.

Figure 27: Device Settings – Port Management

Defining KDS-SW3-EN7 Time and Date

You can sync the device time and date to any server around the world.

To sync device time and date to a server:

1. In the Navigation pane, click **Device Settings**. The General tab in the Device Settings page appears (see [Figure 19](#)).
2. Select the **Time and Date** tab. The Time and Date tab appears:

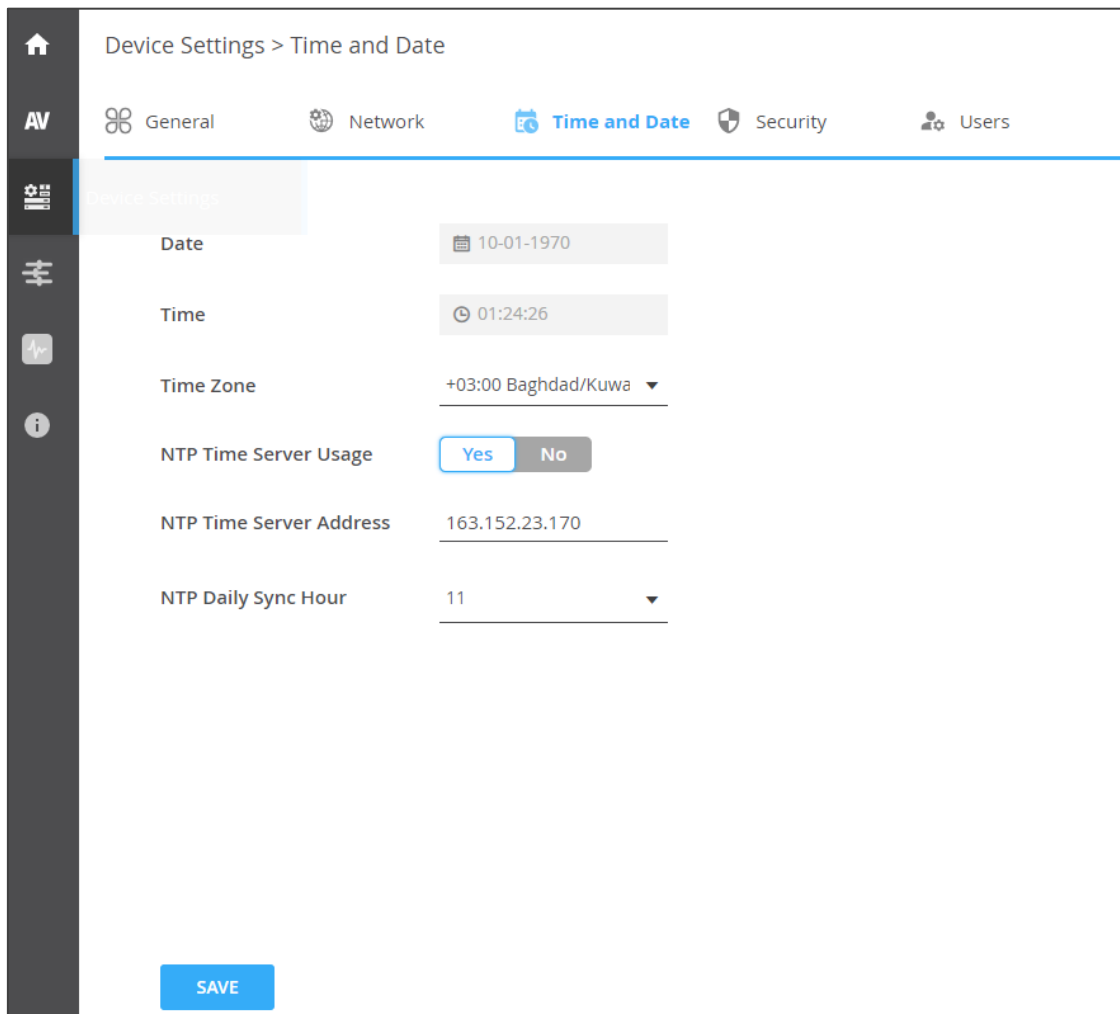

Figure 28: Device Settings Page – Time and Date Tab

3. Next to **NTP Time Server Usage**, click **YES** to use time server (NTP).
Network fields are enabled.
4. Type in server information:
 - Enter the server address.
 - Set daily sync hour.
5. Click **SAVE**.

The device's date and time are synchronized to the server address entered.



The date and time can only be set by NTP synchronization (manual setting is not available).

Setting KDS-SW3-EN7 Security

The Security tab configures device 802.1X authentication to limit unauthorized access, and HTTPS/TLS for establishing an encrypted connection to an authenticated peer over the network.

This section describes the following actions:

- [Configuring HTTPS](#) on page [37](#).
- [Defining 802.1X Authentication](#) on page [38](#).



Contact your IT administrator for the network access authentication.

Configuring HTTPS

To configure HTTPS:

1. In the Navigation pane, click **Device Settings**.
2. Select the **Security** tab:

The screenshot shows the 'Device Settings > Security' page for a Kramer KDS-SW3-EN7 device. The 'Security' tab is selected, and the 'HTTPS' section is expanded. The 'Server' toggle is set to 'On'. Under 'Server Certificate', the 'Server Certificate' radio button is selected, and the 'Upload Certificate' field contains the value 'KDS-SW3-EN7-001D5605'. The 'Private Key Password' field is masked with dots. An 'APPLY & REBOOT' button is visible. Below this, the '802.1X' section is expanded, showing 'IEEE 802.1X Authentication' set to 'On'. The 'Authentication Method' is set to 'EAP-TLS'. Fields for 'Username', 'Client Certificate', 'Private Key', and 'Private Key Password' are present, with the latter two having lock icons. A 'Server Certificate' toggle is set to 'Off', and an 'APPLY' button is at the bottom.

Figure 29: Device Settings Page – Security Tab

3. For HTTPS server, click **On** to enable HTTPS authentication service (default) or **Off** to disable HTTPS authentication.

4. When set to On, check one of the following settings:
 - **Internal Certificate** – Use the factory default certificate for authentication.
 - **Server Certificate** – Submit a certificate from the server for authentication. To do so, click  to upload the certificate. enter the private key password (assigned by the IT administrator) and click **APPLY & REBOOT**.

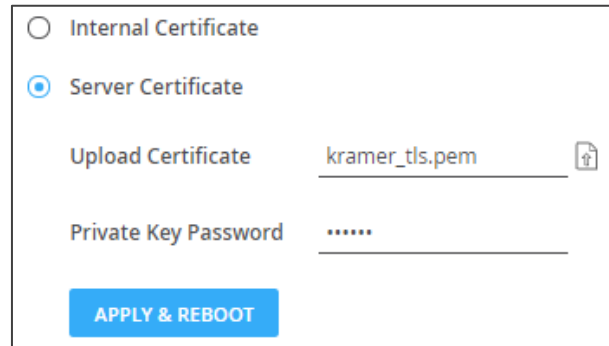

Figure 30: Security Tab – Server Certificate

HTTPS is configured.

Defining 802.1X Authentication

802.1X authenticates external users accessing the network.



If you have SL-Dante traffic and 802.1X authentication using the same port, then make sure that the network switch connected to **KDS-SW3-EN7** supports IEEE 802.1X port-based authentication.

To configure security:

1. In the Navigation pane, click **Device Settings**. The General tab in the Device Settings page appears (see [Figure 19](#)).
2. Select **Security** tab. The Security tab appears (see [Figure 29](#)).
3. For 802.1X authentication, click **ON** to enable 802.1X authentication service. 802.1X supports authentication based on port and MAC address.
4. When set to ON check one of the following settings:
 - **PEAP-MSCHAP V2** – To use this authentication method, enter a Username (up to 24 alphanumeric characters, including “_” and “-“ characters within the username) and Password (up to 24 ASCII characters):

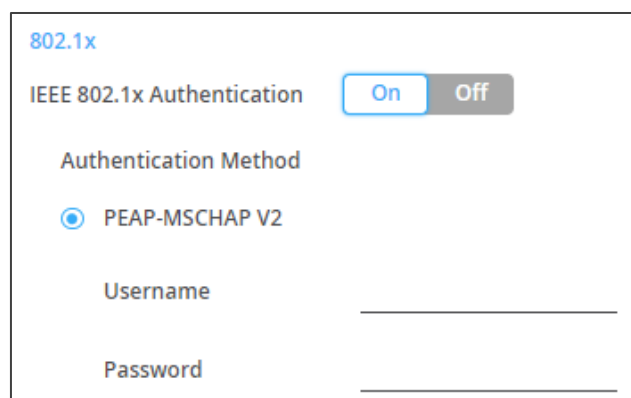

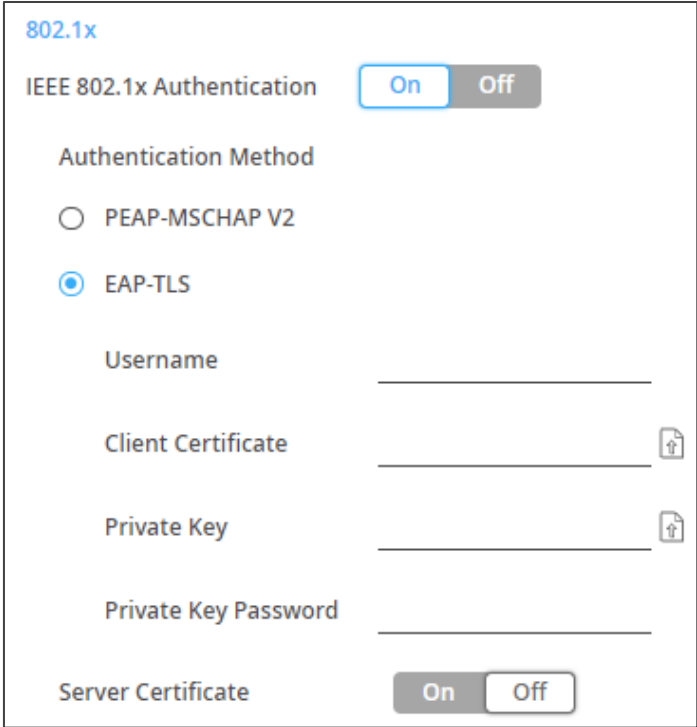

Figure 31: Security Tab – EAP-MSCHAP V2 Authentication

- **EAP-TLS** – To submit certificate from the server for authentication. To do so, enter the Username, click  to upload the certificates and keys, and enter the private key password (assigned by IT administrator). Set Server Certificate **On**.



802.1x

IEEE 802.1x Authentication On Off

Authentication Method

PEAP-MSCHAP V2

EAP-TLS

Username _____

Client Certificate _____ 

Private Key _____ 

Private Key Password _____

Server Certificate On Off

Figure 32: EAP-TLS – Certificates and Password

5. Click **APPLY**.

Security is configured.

Defining KDS-SW3-EN7 User Access

The **Users** tab enables Security: It defines a password that protect access to the embedded webpages. The default user and password is **admin**. By default, security is disabled.

Enabling User Access

To enable password protection on the embedded webpages:

1. In the Navigation pane, click **Device Settings**.
2. Select the **Users** tab:

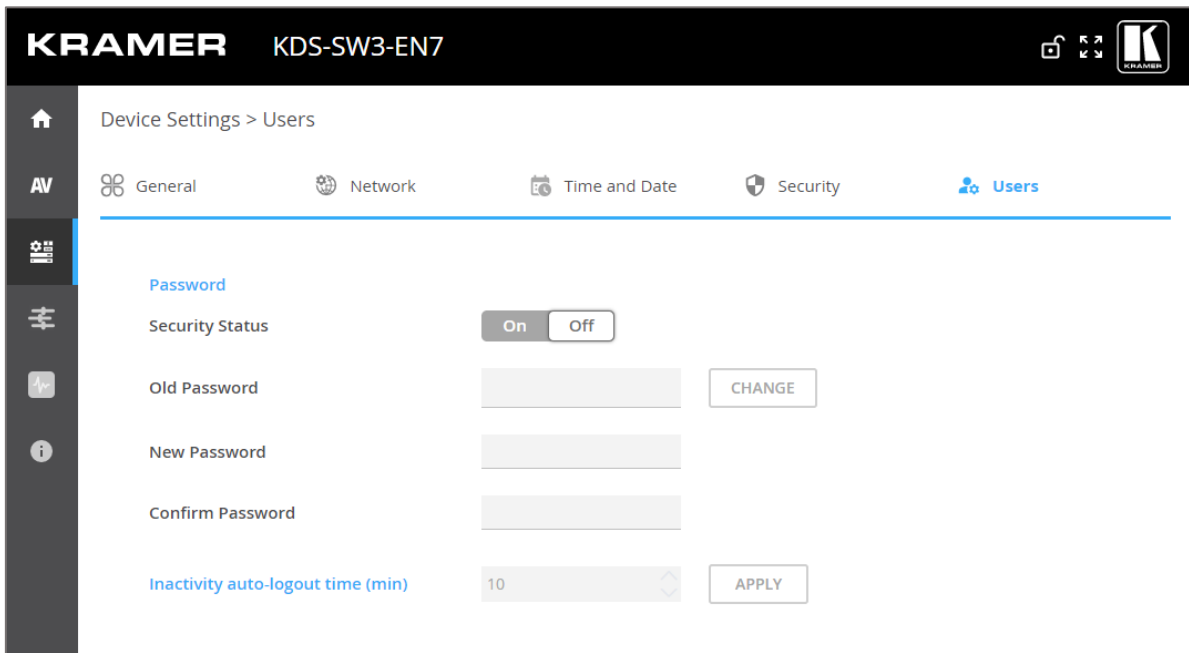

Figure 33: Device Settings Page – Users Tab

3. Click **On** next to **Security Status** to enable user authentication (Off by default). The following message appears.

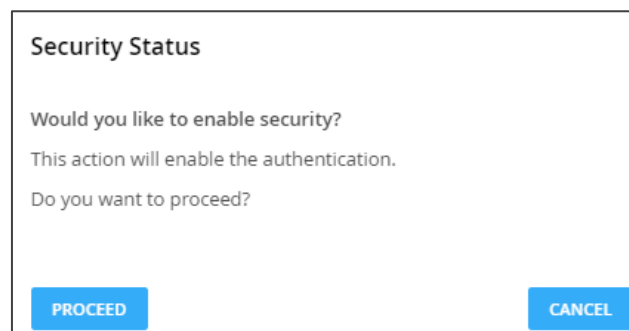

Figure 34: Security Tab – Security Status

4. Click **PROCEED**. The web page refreshes, and the password fields are visible. Security is enabled and access requires authentication.

Disabling User Access

To disable password protection on the embedded webpages:

1. In the Navigation pane, click **Device Settings**.
2. Select the **Users** tab:

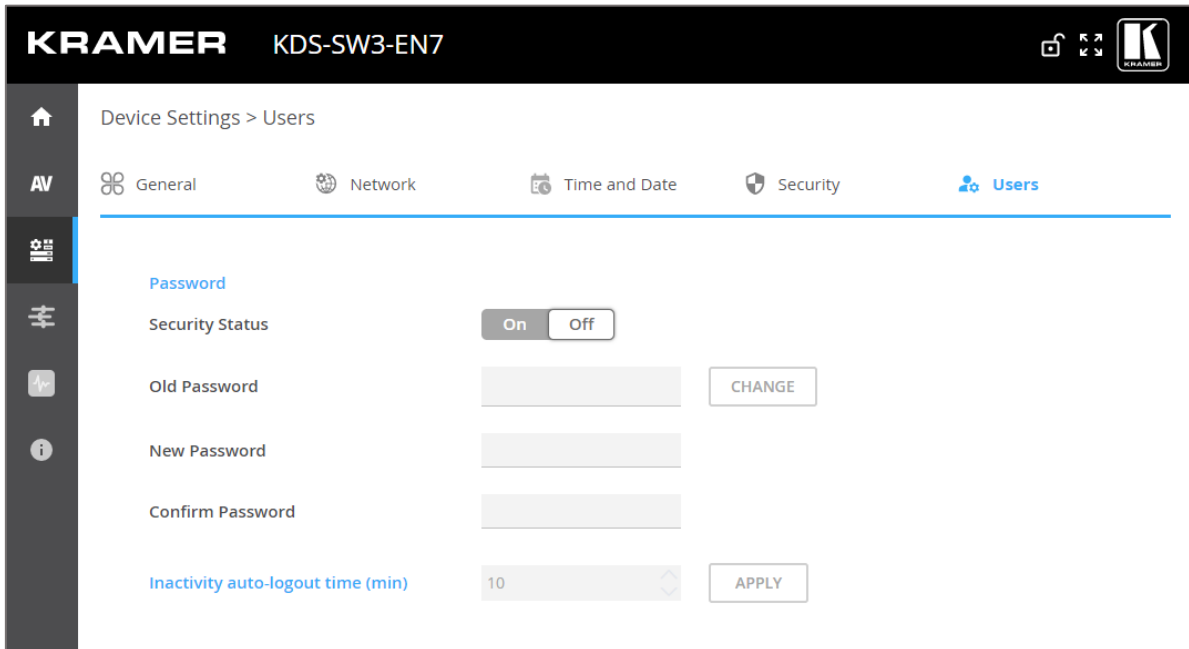

Figure 35: Device Settings – Users Tab

3. Click **Off** in Security Status to disable password use. The following message appears.

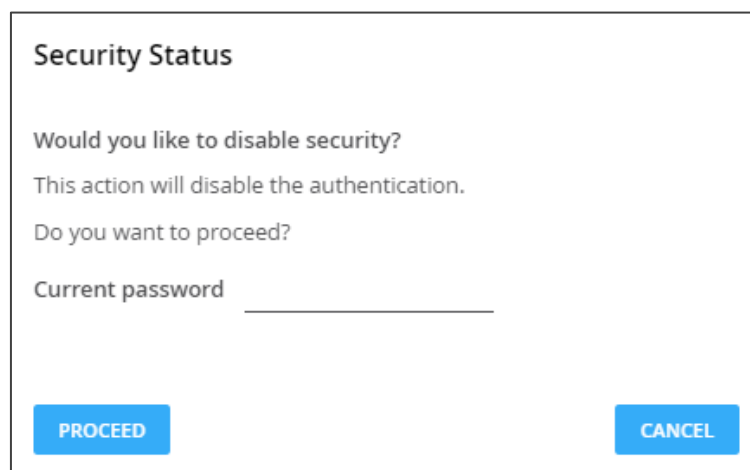

Figure 36: Security Tab – Security Status

4. Enter the current password.
 5. Click **PROCEED**.
- Security is disabled.

Logging Out Automatically

To have the embedded webpages lock automatically after a period of inactivity, set the **Inactivity auto-logout time (in minutes)**.

Changing the Password

To change the password:

1. In the Navigation pane, click **Device Settings**. The General tab in the Device Settings page appears (see [Figure 19](#)).
2. Select Users tab (see [Figure 33](#)).
3. Set security Status to **On**.

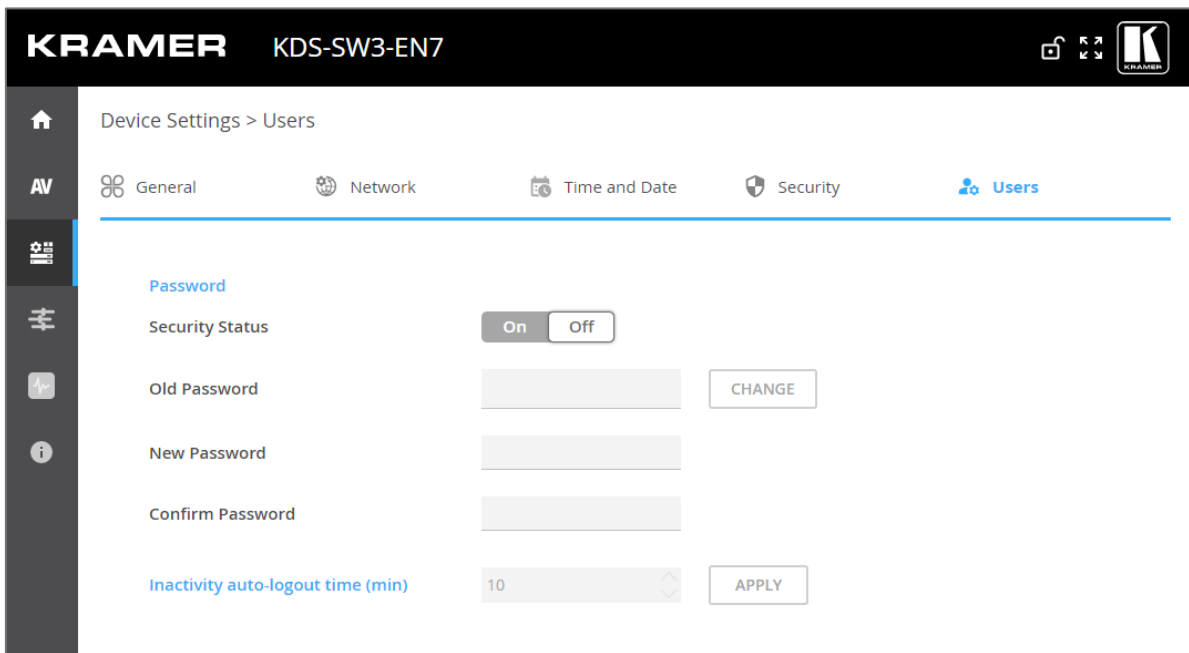

Figure 37: Device Settings – Users Tab

4. Next to Old Password, enter the old password.
5. Next to New Password, enter the new password.



The new password must include at least one number, one special character (excluding spaces or commas), one uppercase and one lowercase letter and should be 8 to 24 characters long.

6. Next to Confirm Password, enter the new password again.
7. Click **CHANGE**.

Password has changed.

Defining KDS-SW3-EN7 Gateway Settings

KDS-SW3-EN7 enables configuring CEC, RS-232 and/or IR gateway Control. You can perform the following actions:

- [Configuring CEC Settings](#) on page [43](#).
- [Configuring RS-232 Settings](#) on page [44](#).
- [Configuring IR Settings](#) on page [45](#).

Configuring CEC Settings

KDS-SW3-EN7 sends CEC commands from a control system, connected by LAN, via the KDS-SW3-EN7 built-in control gateway, to control CEC enabled devices that are connected to the KDS-SW3-EN7 HDMI output or input.

To set CEC Gateway:

1. In the Navigation pane, click **Control**. The Control>Settings page appears.

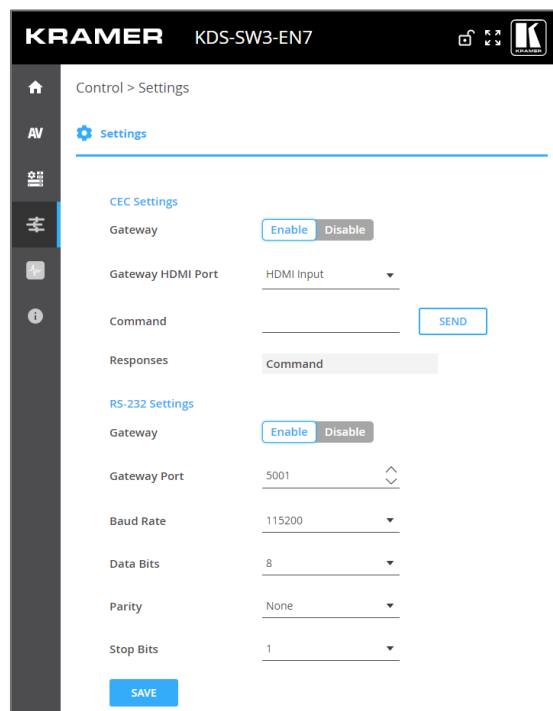

Figure 38: Control > Settings Page – CEC Settings

2. Click **Enable** to enable CEC gateway or click **Disable**.
3. Select the HDMI port from the drop-down list to which CEC commands are sent:
 - HDMI Input (HDMI IN).
 - HDMI Loop Through (HDMI OUT).
4. Enter the CEC command. Use hex format for the CEC command, up to 32 hex digits.
5. Click **SEND**.
6. View the CEC-enabled device response.

CEC Gateway is configured.

Configuring RS-232 Settings

KDS-SW3-EN7 sends RS-232 commands from a control system, connected by LAN, via the KDS-SW3-EN7 built-in control gateway, to devices that are connected to the KDS-SW3-EN7 RS-232 port.

To set RS-232 Gateway:

1. In the Navigation pane, click **Control**. The Control>Settings page appears (see [Figure 38](#)).

The screenshot shows the 'RS-232 Settings' page. At the top, there is a title 'RS-232 Settings'. Below it, there are several configuration fields:

- Gateway:** A toggle switch with 'Enable' (highlighted in blue) and 'Disable' buttons.
- Gateway Port:** A text input field containing '5002' and a dropdown arrow.
- Baud Rate:** A dropdown menu showing '115200'.
- Data Bits:** A dropdown menu showing '8'.
- Parity:** A dropdown menu showing 'None'.
- Stop Bits:** A dropdown menu showing '1'.

At the bottom of the settings area, there is a blue 'SAVE' button.

Figure 39: Control > Settings Page – RS-232 Settings

2. Click **Enable** to enable RS-232 gateway or click **Disable**.
3. Define the RS-232 gateway port (5001, by default).
4. Enter the Baud Rate: 9600, 19200, 38400, 57600 or 115200 (default).
5. Enter the Data Bits: 5, 6, 7 or 8 (default).
6. Enter Parity: None (default), Odd or Even.
7. Enter Stop Bits: 1 (default) or 2.
8. Click **SAVE**.

RS-232 Gateway is configured.

Configuring IR Settings

KDS-SW3-EN7 sends IR commands from a control system, connected by LAN, via the KDS-SW3-EN7 built-in control gateway, to IR connected devices.

To set RS-232 Gateway:

1. In the Navigation pane, click **Control**. The Control>Settings page appears.

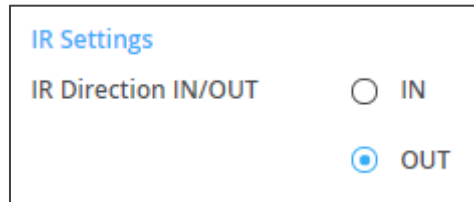

Figure 40: Control > Settings Page – IR Settings

2. Set IR direction:
 - **IN** – Configure the IR port as an input port that is connected to an IR receiver cable.
 - **OUT** – Configure the IR port as an output port that is connected to an IR emitter cable.

IR Gateway is configured.

Viewing KDS-SW3-EN7 Status

This page shows the status of the device, its input and output ports, the active external connections and a count of the CEC, RS-232 and IR messages received and sent.

To view device status:

1. In the Navigation pane, click **Diagnostics**. The Status tab appears.

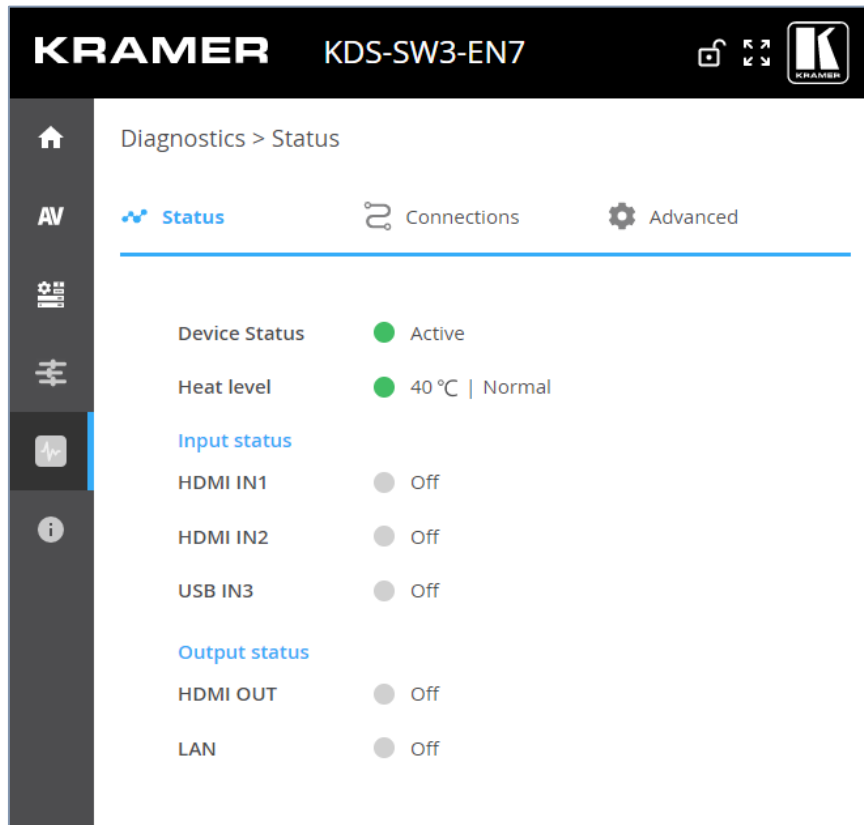

Figure 41: Diagnostics – Status Tab

2. View the Device Status:
 - **Active**, for normal operation (green indication).
3. View device internal heat status:
 - **Normal**, for temperatures under 45°C (green indication).
 - **High**, for temperatures between 45°C and 60°C (orange indication).
 - **Overheat**, for temperatures higher than 60°C (red indication).
4. View the status for each input:
 - **On**, when the input has a valid signal and is transmitting a signal (green indication).
 - **Off**, when an input is not connected or there is no valid signal (gray indication).
5. View HDMI OUT and LAN output status:
 - **On**, when an output is transmitting a signal (green indication).
 - **Off**, when an output has no signal output (gray indication).

Device status is viewed.

Viewing KDS-SW3-EN7 Connections Status

View the connection information status.

To view Connections status:

- 1. In the Navigation pane, click **Diagnostics**.
- 2. Select the **Connections** tab.

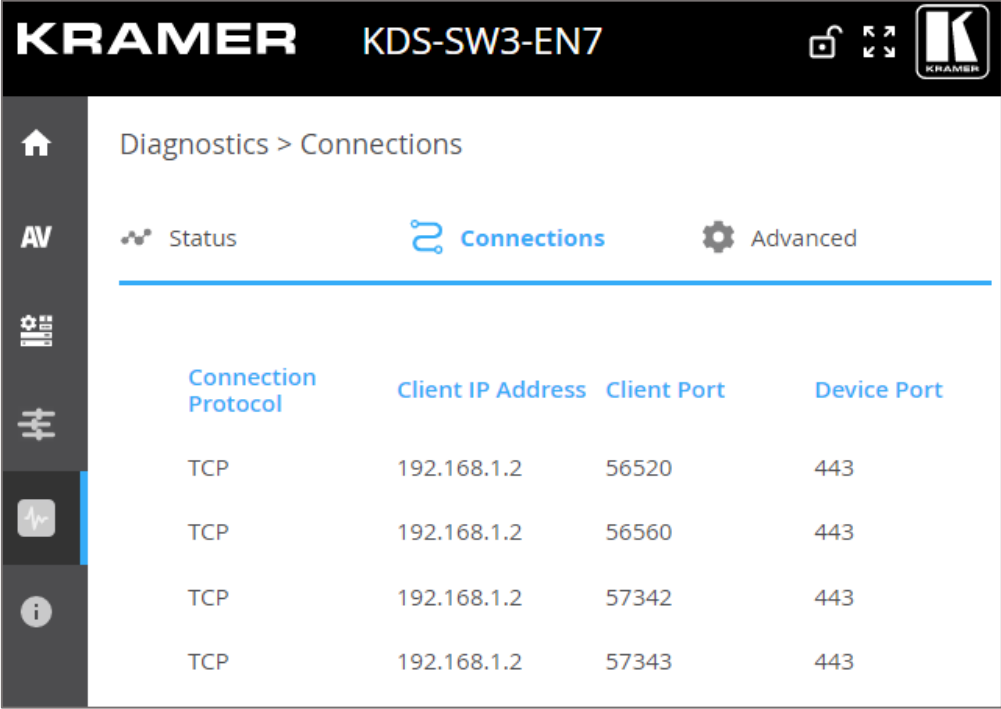

Figure 42: Diagnostics – Status Tab

- 3. View the active connections to the device and their details.
Connections' status is viewed.

Viewing KDS-SW3-EN7 Advanced Status

Activate logging, view and download the log and see a counter of the gateway messages.

To view the log and message counter:

1. In the Navigation pane, click **Diagnostics**.
2. Select the **Advanced** tab.

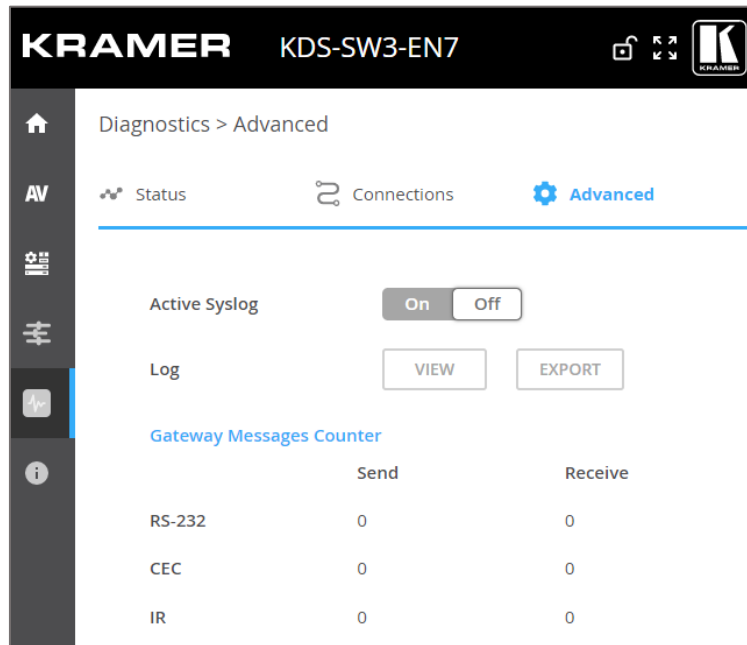

Figure 43: Diagnostics – Advanced Tab

3. Activate the logging in the **Active Syslog** field:
 - **On**, to activate logging.
 - **Off** (default), to disable logging.
4. Click **VIEW** to view the system log (if active).
5. Click **EXPORT** to export the system log (in .txt format) to the local PC.
6. The **Gateway Messages Counter** is displayed online.

System log and counters are viewed.

Viewing the About Page

View the web page hardware release, firmware version and Kramer Electronics Ltd details in the About page.

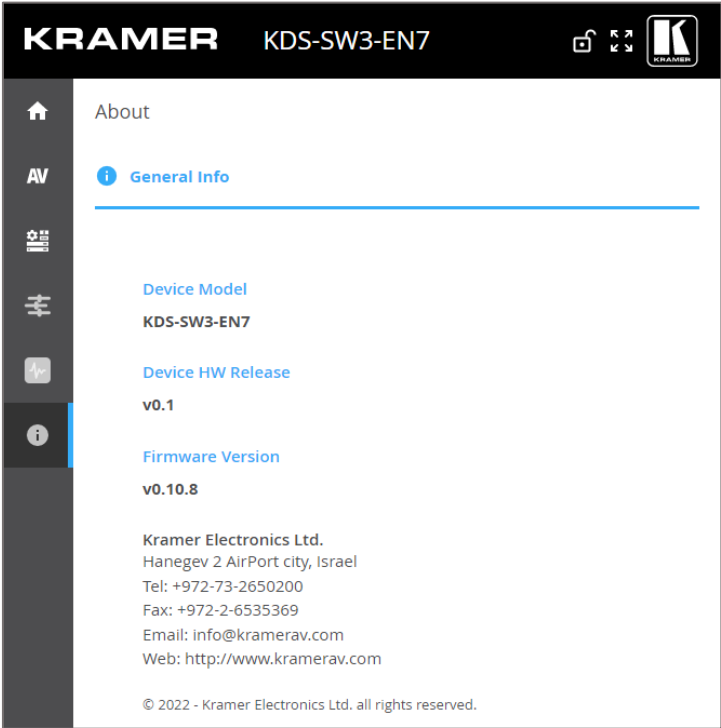



Figure 44: About Page

Upgrading Firmware

Upgrade the firmware, view the date of the last upgrade, or rollback to the previous firmware revision in case of a problem.

 Click **ROLLBACK** to update to the previous FW version.

 If the device firmware version is lower than 0.11.11, contact Kramer tech support team at support@kramerav.com or go to our Web site at k.kramerav.com/support/downloads.asp.

To upgrade the firmware:

1. Open the **Device Settings** page. The General tab in the Device Settings page appears.
2. Next to Firmware Version, click **UPGRADE**. The Open window appears.

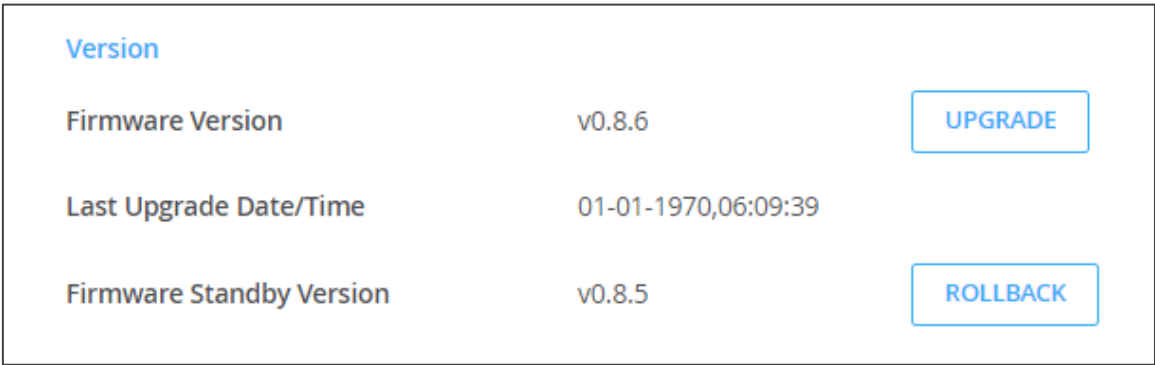

Figure 45: General Tab – Upgrading the Firmware

3. Select the FW file and click **Open**. The FW upgrade pop-up window appears. Wait for upgrade completion.
4. Once completed, refresh the web page and log-in.
Firmware upgrade is complete.

Technical Specifications

KDS-SW3-EN7 Specifications

Inputs	2 HDMI		On a female HDMI connector	
	1 USB		On a USB-C connector	
Outputs	1 HDMI		On a female HDMI connector	
Ports	2 Ethernet		On RJ-45 female connectors	
	1 Balanced Audio		On a 5-pin terminal block connector	
	1 RS-232		On a 3-pin terminal block connector	
	1 IR		On a 3.5mm TRS connector	
	1 USB-B Host		On a USB-B connector	
	2 USB-A Devices		On USB-A connectors	
Network	1G			
	Multicast		Through RTSP (Real Time Streaming Protocol): IGMP snooping non-blocking, Layer 2	
	Unicast		Through RTSP	
	Bit Rate		Peak: 850Mbps 4K average: 350Mbps 1080p average: 250Mbps	
Video Streaming	Compression Standard		JPEG2K based, private stream	
	Max Input Resolution		4K@60Hz (4:2:0)	
	Max End-to-End Resolution		4K@30 (4:4:4)	
	Scaler		Yes	
	End to End Latency		33 msec	
	Switching Time		1 sec	
Resolution	4096x2160@60Hz, 3840x2160@60Hz, 1920x1200@50Hz, 1920x1080@60Hz, 1856x1392@60Hz, 1792x1344@60Hz, 1680x1050@60Hz,	1600x1200@60Hz, 1600x900@60Hz, 1440x900@60Hz, 1400x1050@60Hz, 1366x768@60Hz, 1360x768@60Hz,	1280x960@60Hz, 1280x800@60Hz, 1280x768@60Hz, 1280x720@60Hz, 1224x768@70Hz, 1152x864@70Hz, 1024x768@60Hz,	848x480@60Hz, 800x600@60Hz, 720x576@60Hz, 720x480@50Hz, 640x480@60Hz, 640x400@85Hz, 640x350@85Hz
Digital Audio	2-channel Dante Out		On an Ethernet connector	
Security	HTTPS, 802.1x, OWASP-10			
User Interface	Indicators		LINK, NET and ON LEDs, front panel LCD Display	
	Rear Panel		Restart and factory reset button	
	Controls		Embedded web pages, P3K API commands via Ethernet, front panel navigation buttons	
Power	Options		PoE on LAN (PoE) port	
	Consumption		24V DC, 3.7A Max.	
	Source		24V DC, 5A (optional, purchased separately)	
Environmental Conditions	Operating Temperature		0° to +45°C (32° to 113°F)	
	Storage Temperature		-20° to +70°C (-4° to 158°F)	
	Humidity		10% to 90%, RHL non-condensing	
Regulatory Compliance	Safety		CE, FCC	
	Environmental		RoHs, WEEE	
Enclosure	Size		Mega Tool Deep	
	Type		Aluminum	

	Cooling	Convection Ventilation
General	Net Dimensions (W, D, H)	19cm x 14.5cm x 2.8cm (7.5" x 5.7" x 1.1")
	Shipping Dimensions (W, D, H)	31cm x 18cm x 7.6cm (12.2" x 7.09" x 2.99")
	Net Weight	0.67kg (1.4lbs) approx.
	Shipping Weight	0.93kg (2lbs) approx.
Specifications are subject to change without notice at www.kramerav.com		

Default Communication Parameters

P3K	
Example (stop encoder decoder activity)	#KDS-ACTION 0<CR>
Ethernet	
To reset the IP settings to the factory reset values go to: Menu->Setup -> Factory Reset-> press Enter to confirm	
DHCP	Default
IP Address:	192.168.1.39
Subnet mask:	255.255.255.0
Default gateway:	192.168.1.254
TCP Port #:	5000
UDP Port #:	50000
Default username:	admin
Default password:	admin
Full Factory Reset	
Embedded web pages	Device Settings > General > RESET
Front panel buttons	Press the RESET button on the rear panel for 10 seconds

Default EDID

Block 0

	0	1	2	3	4	5	6	7	8	9	A	B	C	D	E	F
00	00	FF	FF	FF	FF	FF	FF	00	2D	B2	00	00	01	00	00	00
10	25	1F	01	03	80	59	32	78	0A	EE	91	A3	54	4C	99	26
20	0F	50	54	21	08	00	81	00	A9	C0	01	01	01	01	01	01
30	01	01	01	01	01	01	02	3A	80	D0	72	38	2D	40	10	2C
40	45	80	20	C2	31	00	00	1E	E7	31	80	A0	70	B0	1D	40
50	30	20	36	00	59	32	00	00	00	1A	00	00	00	F7	00	0A
60	00	4A	A2	24	02	00	00	00	00	00	00	00	00	00	00	FC
70	00	4B	44	53	37	20	45	6E	63	6F	64	65	72	0A	01	36

Block Type: Base EDID

Checksum verified

Version 1 header verified

Manufacturer: KMR

Product Code: 0 (0000h)

Serial #: 1 (00000001h)

Date of Manufacture: Week 37 of 2021

EDID Version 1, Revision 3

Number of additional blocks: 1

Basic Display Parameters and Features

•Video Input Definition: Digital
VESA DFP 1.x non compatible

Horizontal Screen Size: 89 cm

Vertical Screen Size: 50 cm

Display Transfer Characteristics (Gamma) 2.20

Active off: No

Suspend: No

Standby: No

RGB color display

sRGB is not used as default

Preferred Timing is native

Display is non-continuous frequency (multi-mode)

Chromaticity

Red: (0.640, 0.330)

Green: (0.300, 0.600)

Blue: (0.150, 0.060)

White: (0.313, 0.329)

Established Timings I

640 x 480 @ 60Hz

800 x 600 @ 60Hz

Established Timings II

1024 x 768 @ 60Hz

Manufacturer's Timings:

None

Standard Timings

Timing 1: 1280 x 800 @ 60 Hz (16:10)
 Timing 2: 1600 x 900 @ 60 Hz (16:9)
 Timing 3: Not Used
 Timing 4: Not Used
 Timing 5: Not Used
 Timing 6: Not Used
 Timing 7: Not Used
 Timing 8: Not Used

Descriptor Block: Detailed Timing (DTD)

Pixel clock: 148.500 MHz
 Refresh Rate: 50.000 Hz (approx.)
 Scan type: Progressive
 Horz Active: 1920
 Vert Active: 1080
 Horz Blank: 720
 Vert Blank: 45
 HSync Delay: 528
 HSync Width: 44
 VSync Delay: 4
 VSync Width: 5
 Image size: 800 mm x 450 mm
 Border: 0 pixels x 0 lines
 Stereo mode: Normal display, no stereo
 Sync: Digital Separate, VSYNC+, HSYNC+

Descriptor Block: Detailed Timing (DTD)

Pixel clock: 127.750 MHz
 Refresh Rate: 49.974 Hz (approx.)
 Scan type: Progressive
 Horz Active: 1920
 Vert Active: 1200
 Horz Blank: 160
 Vert Blank: 29
 HSync Delay: 48
 HSync Width: 32
 VSync Delay: 3
 VSync Width: 6
 Image size: 89 mm x 50 mm
 Border: 0 pixels x 0 lines
 Stereo mode: Normal display, no stereo
 Sync: Digital Separate, VSYNC-, HSYNC+

Descriptor Block: Established Timings III

Version: 10
 Supported Timings
 1280 x 768 @ 60 Hz
 1280 x 960 @ 60 Hz
 1280 x 1024 @ 60 Hz
 1360 x 768 @ 60 Hz
 1440 x 900 @ 60 Hz
 1400 x 1050 @ 60 Hz
 1680 x 1050 @ 60 Hz
 1600 x 1200 @ 60 Hz
 1920 x 1200 @ 60 Hz (RB)

Descriptor Block: Display Product Name

Value: KDS7 Encoder

Block 1

	0	1	2	3	4	5	6	7	8	9	A	B	C	D	E	F
00	02	03	40	F3	4F	9F	10	21	20	14	05	5F	5E	5D	64	63
10	62	04	02	11	23	09	07	01	83	01	00	00	6E	03	0C	00
20	10	00	38	3C	20	00	80	01	02	03	04	67	D8	5D	C4	01
30	3C	80	00	E5	0E	60	61	65	66	E2	00	F9	E3	05	E0	00
40	66	21	56	AA	51	00	1E	30	46	8F	33	00	59	32	00	00
50	00	9E	00	00	00	00	00	00	00	00	00	00	00	00	00	00
60	00	00	00	00	00	00	00	00	00	00	00	00	00	00	00	00
70	00	00	00	00	00	00	00	00	00	00	00	00	00	00	00	1D

Block Type: CTA 861

Checksum verified
 E-EDID CTA Extension Version 3
 Reserved data block offset 64

- Native DTDs in EDID: 3
- Y: Supports underscan
- Y: Supports basic audio
- Y: Supports YCbCr 4:4:4
- Y: Supports YCbCr 4:2:2

CTA Data Block: Tag 2, bytes 15: Video Data

Number of Descriptors: 15

SVD #001: (31) 1920x1080p @ 50 Hz 16:9 Native
 SVD #002: (16) 1920x1080p @ 60 Hz 16:9
 SVD #003: (33) 1920x1080p @ 25 Hz 16:9
 SVD #004: (32) 1920x1080p @ 24 Hz 16:9
 SVD #005: (20) 1920x1080i @ 50 Hz 16:9
 SVD #006: (5) 1920x1080i @ 60 Hz 16:9
 SVD #007: (95) 3840x2160p @ 30 Hz 16:9
 SVD #008: (94) 3840x2160p @ 25 Hz 16:9
 SVD #009: (93) 3840x2160p @ 24 Hz 16:9
 SVD #010: (100) 4096x2160p @ 30 Hz 256:135
 SVD #011: (99) 4096x2160p @ 25 Hz 256:135

SVD #012: (98) 4096x2160p @ 24 Hz 256:135
 SVD #013: (4) 1280x720p @ 60 Hz 16:9
 SVD #014: (2) 720x480p @ 60 Hz 4:3
 SVD #015: (17) 720x576p @ 50 Hz 4:3

CTA Data Block: Tag 1, bytes 3: Audio Data

Number of Descriptors: 1

Audio Format Code: LPCM (IEC 60958 PCM [30, 31])
 Channels: 2
 Sampling Freq: 32 kHz, 44.1 kHz, 48 kHz
 Sampling Size (bit): 16

CTA Data Block: Tag 4, bytes 3: Speaker Allocation

- Front Left/Front Right (FL/FR)

CTA Data Block: Tag 3, bytes 14: Vendor Specific

24-bit IEEE Registration ID: 0x000C03

HDMI 1.4b Vendor Specific Data Block

- CEC Physical Address: 1.0.0.0
- ISRC/ACP: Not supported
- Deep Color
 - 36 bits per color
 - 30 bits per color
 - YCbCr 4:4:4 supported
- DVI dual-link: Not supported
- Max TMDS clock: 300 MHz
- Content types: None
- Latency: Not Present
- Interlaced Latency: Not Present
- Basic 3D: Not supported
- Image Size: No additional information.
- 4K x 2K Support:
 - 3840x2160 30Hz
 - 3840x2160 25Hz
 - 3840x2160 24Hz
 - 4096x2160 24Hz

CTA Data Block: Tag 3, bytes 7: Vendor Specific

24-bit IEEE Registration ID: 0xC45DD8

HDMI Forum Vendor Specific Data Block

- Version: 1
- Max_TMDS_Character_Rate: 300 MHz
- Max_FRL_Rate: Not Supported

Y: SCDC_Present
 N: RR_Capable
 N: CABLE_STATUS
 N: CCBPCI
 N: LTE_340MHz_scramble
 N: Independent_view
 N: Dual_View
 N: 3D_OSD_Disparity
 N: UHD_VIC
 N: DC_48bit_420
 N: DC_36bit_420
 N: DC_30bit_420

CTA Data Block: Extended Tag 14, bytes 5: Y420 Video Data

Number of Descriptors: 4

SVD #016: (96) 3840x2160p @ 50 Hz 16:9
 SVD #017: (97) 3840x2160p @ 60 Hz 16:9
 SVD #018: (101) 4096x2160p @ 50 Hz 256:135
 SVD #019: (102) 4096x2160p @ 60 Hz 256:135

CTA Data Block: Extended Tag 0, bytes 2: Video Capability

CE: Always overscanned
 IT: Always underscanned
 PT: Supports over and underscan
 RGB Quantization: Selectable (via AVI Q)
 YCC Quantization: Selectable (via AVI YQ)

CTA Data Block: Extended Tag 5, bytes 3: Colorimetry

BT.2020-cYCC
 BT.2020-YCC
 BT.2020-RGB

Descriptor Block: Detailed Timing (DTD)

Pixel clock: 85.500 MHz
 Refresh Rate: 59.790 Hz (approx.)
 Scan type: Interlace
 Horz Active: 1366
 Vert Active: 768
 Horz Blank: 426
 Vert Blank: 30
 HSync Delay: 70
 HSync Width: 143
 VSync Delay: 3
 VSync Width: 3
 Image size: 89 mm x 50 mm
 Border: 0 pixels x 0 lines
 Stereo mode: Normal display, no stereo
 Sync: Digital Separate, VSYNC+, HSYNC+

Default Parameters

KDS-SW3-EN7 Default Parameters

Page Name	Tab Name	Fields	Editable Field	Exportable Field	Default Values
Main	AV Routing	Channel ID	Yes	Yes	1
		Channel Name	Yes	Yes	KDS-SW3-EN7-xxxxxxxxxxxx "xxxxxxxxxxxx" is the device's MAC address.
		Volume	Yes	Yes	80
		Mute	Yes	Yes	Off
		Play/Stop	Yes	Yes	Play
AV Settings	Video	Input 1	Yes	Yes	On
		Maximum Bit Rate	Yes	Yes	Best Effort
		Maximum Video Frame Rate (%)	Yes	Yes	100%
	Audio	Analog Audio Direction IN/OUT	Yes	Yes	IN
		Audio Source Mode	Yes	Yes	Last Connected
		Audio Connection Guard Time (sec)	Yes	Yes	10
EDID	EDID Lock	Yes	Yes	On	
Device Settings	General	Host Name	Yes	Yes	KDS-SW3-EN7-xxxxxxxxxxxx ("xxxxxxxxxxxx" is the device's MAC address)
		Export Device Settings	Yes	Yes	All including IP
		Front Panel Lock	Yes	Yes	Off
	Network	Stream Port	No	Yes	Media
		Stream 802.1Q	No	Yes	N/A
		Stream VLAN Tag	No	Yes	N/A
		Stream DHCP	Yes	Yes	On
		P3K & Gateway Port	Yes	Yes	Media
		P3K & Gateway 802.1Q	Yes	Yes	Off
		P3K & Gateway VLAN Tag	Yes	Yes	2
		P3K & Gateway DHCP	Yes	Yes	2
		Dante Port	Yes	Yes	Media
		Dante 802.1Q	Yes	Yes	Off
		Dante VLAN Tag	Yes	Yes	2
		Dante DHCP	Yes	Yes	On
		IP Casting Mode	Yes	Yes	Multicast
		TTL	Yes	Yes	64
	TCP Port	Yes	Yes	5,000	
	UDP Port	Yes	Yes	50,000	
	Time and Date	Date	Yes	Yes	01-01-1970
		Time	Yes	Yes	N/A
		Time Zone	Yes	Yes	00:00 Greenwich
		NTP Time Server Usage	Yes	Yes	No
NTP Time Server Address		Yes	Yes	N/A	
Security	NTP Daily Sync Hour	Yes	Yes	N/A	
	HTTPS Server	Yes	Yes	On; Internal Certificate	
Users	IEE 802.1X Authentication	Yes	Yes	Off	
	Security Status	Yes	Yes	Off	
Control	Settings	Inactivity auto-logout time	Yes	Yes	10
		CEC Gateway	Yes	Yes	Enable
		CEC Gateway HDMI Port	Yes	Yes	HDMI Input
		RS232 Gateway	Yes	Yes	Enable
		RS232 Port	Yes	Yes	5001
		RS232 Baud rate	Yes	Yes	115200
RS232 Data Bits	Yes	Yes	8		

Page Name	Tab Name	Fields	Editab le Field	Exportabl e Field	Default Values
		Parity	Yes	Yes	None
		Stop Bits	Yes	Yes	1
		IR Direction IN/OUT	Yes	Yes	In
Diagnostics	Advanced	Active Syslog	Yes	Yes	Off

Protocol 3000

Kramer devices can be operated using Kramer Protocol 3000 commands sent via Ethernet ports.

Understanding Protocol 3000

Protocol 3000 commands are a sequence of ASCII letters, structured according to the following.

- **Command format:**

Prefix	Command Name	Constant (Space)	Parameter(s)	Suffix
#	Command	␣	Parameter	<CR>

- **Feedback format:**

Prefix	Device ID	Constant	Command Name	Parameter(s)	Suffix
~	nn	@	Command	Parameter	<CR><LF>

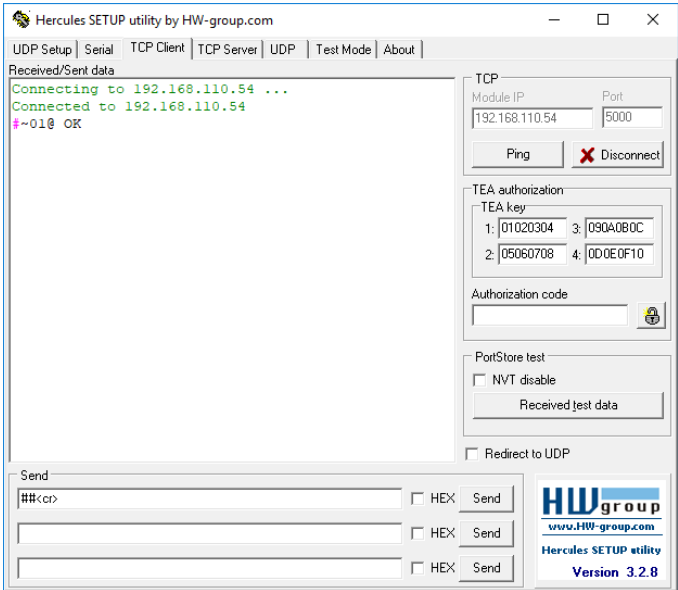

- **Command parameters** – Multiple parameters must be separated by a comma (,). In addition, multiple parameters can be grouped as a single parameter using brackets ([and]).
- **Parameters attributes** – Parameters may contain multiple attributes. Attributes are indicated with pointy brackets (<...>) and must be separated by a period (.).

The command framing varies according to how you interface with the **KDS-SW3-EN7**. The following figure displays how the # command is framed using terminal communication software (such as Hercules):



Protocol 3000 Commands

Function	Description	Syntax	Response	Parameters/Attributes	Example
#	Protocol handshaking. ① Validates the Protocol 3000 connection and gets the machine number. Step-in master products use this command to identify the availability of a device.	#<CR>	~nn@lok<CR><LF>		#<CR>
BEACON-EN	Set beacon rate.	#BEACON-EN port_id,status,rate<CR>	~nn@BEACON-EN port_id,status,rate<CR><LF>	port_id – ID of the Ethernet port 0 – Media Port 1 – Service Port status – Enable/Disable beacon 0 – Disable (default) 1 – Enable rate – Repetition rate in seconds 1 – 1 second (minimum) 10 – 10 seconds (default) 1800 – 30 minutes (maximum)	Set media port beacon information to 10 seconds: #BEACON-EN 0,1,10<CR>
BEACON-EN?	Get beacon rate.	#BEACON-EN ?<CR>	~nn@BEACON-EN port_id,status,rate<CR><LF>	port_id – ID of the Ethernet port 0 – Media Port 1 – Service Port status – Enable/Disable beacon 0 – Disable (default) 1 – Enable rate – Repetition rate in seconds 1 – 1 second (minimum) 10 – 10 seconds (default) 1800 – 30 minutes (maximum)	Get beacon information to 10 seconds: #BEACON-EN?<CR>
BEACON-INFO?	Get beacon information, including IP address, UDP control port, TCP control port, MAC address, model, name. ① There is no Set command. Get command initiates a notification.	#BEACON-INFO?_port_id<CR>	~nn@BEACON-INFO port_id,ip_string,udp_port,tcp_port,mac_address,model,name<CR><LF>	port_id – ID of the Ethernet port 0 – Media Port 1 – Service Port ip_string – Dot-separated representation of the IP address udp_port – UDP control port tcp_port – TCP control port mac_address – Dash-separated mac address model – Device model name – Device name	Get beacon information: #BEACON-INFO? 0<CR>
BUILD-DATE?	Get device build date.	#BUILD-DATE?<CR>	~nn@BUILD-DATE date,time<CR><LF>	date – Format: YYYY/MM/DD time – Format: hh:mm:ss where	Get the device build date: #BUILD-DATE?<CR>
CEC-GW-PORT-ACTIVE	Set CEC Gateway mode - Whether CEC commands coming from HDMI stream (passthrough) or from LAN.	#CEC-GW-PORT-ACTIVE gw_mode<CR>	~nn@CEC-GW-PORT-ACTIVE gw_mode<CR><LF>	gw_mode mode 0 – CEC Passthrough mode 1 – CEC Gateway mode – command to be sent to HDMI Input. 3 – CEC Gateway mode – command to be sent to HDMI Loop Through	Set CEC Gateway mode: #CEC-GW-PORT-ACTIVE_1<CR>
CEC-GW-PORT-ACTIVE?	Get CEC Gateway mode - Whether CEC commands coming from HDMI stream to LAN.	#CEC-GW-PORT-ACTIVE?<CR>	~nn@CEC-GW-PORT-ACTIVE gw_mode<CR><LF>	CEC mode 0 – CEC Passthrough mode 1 – CEC Gateway mode – command to be sent to HDMI Input. 3 – CEC Gateway mode – command to be sent to HDMI Loop Through	Get CEC Gateway mode: #CEC-GW-PORT-ACTIVE?<CR>
CEC-NTFY	Notify about CEC command retrieved from bus. ① Notification is sent to all com ports upon CEC message retrieval from CEC bus.	#CEC-NTFY<CR>	~nn@CEC-NTFY port_index,len,<cec_command...><CR><LF>	port_index – CEC port notifying the command len – 1-16 cec_command – CEC format command (in HEX format, no leading zeros, no '0x' prefix)	Notify about CEC command retrieved from bus: #CEC-NTFY 0F36<CR>
CEC-SND	Send CEC command to port.	#CEC-SND port_index,sn_id,cmd_name,cec_len ,cec_command<CR>	~nn@CEC-SND port_index,sn_id,cmd_name,cec_mode<CR><LF>	port_index – CEC port transmitting the command (1 – number of ports) sn_id – serial number of command for flow control and response commands from device cmd_name – command name cec_len – 1-16 cec_command – CEC format command (in HEX format, no leading zeros, no '0x' prefix) cec_mode – CEC mode 0 – Sent (only supports Sent, other options result in P3K error code).	Send CEC command to port: #CEC-SND 1,1,1,2,E004<CR>
COM-ROUTE-ADD	Add a communication route tunnel connection.	#COM-ROUTE-ADD com_id,port_type,port_id,eth_rep_en,timeout<CR>	~nn@COM-ROUTE-ADD com_id,port_type,port_id,eth_rep_en,timeout<CR><LF>	com_id – Machine dependent (number of ports, only 1 accepted) port_type – TCP/UDP 0 – TCP only. port_id – TCP/UDP port number (5000 – 5999) eth_rep_en – Ethernet Reply 0 – COM port does not send replies to new clients 1 – COM port sends replies to new clients. timeout – Keep alive timeout in seconds (1 to 3600)	Add a communication route tunnel connection: #COM-ROUTE-ADD 1,0,5001,1,1<CR>

Function	Description	Syntax	Response	Parameters/Attributes	Example
COM-ROUTE-REMOVE	Remove a communication route tunnel connection.	#COM-ROUTE-REMOVE com_id<CR>	~nn@COM-ROUTE-REMOVE com_id<CR><LF>	com_id – Machine dependent	Remove a communication route tunnel connection: #COM-ROUTE-REMOVE,1<CR>
COM-ROUTE?	Get communication route tunnel connection state.	#COM-ROUTE?_com_id<CR>	~nn@COM-ROUTE com_id,port_type,port_id,eth_rep_en,timeout<CR><LF>	com_id – Machine dependent port_type – TCP/UDP 0 – TCP 1 – UDP port_id – TCP/UDP port number eth_rep_en – Ethernet Reply 0 – COM port does not send replies to new clients 1 – COM port sends replies to new clients. timeout – Keep alive timeout in seconds (1 to 3600)	Get tunneling port routing for all route tunnels: #COM-ROUTE? *<CR>
CS-CONVERT	Set the "force RGB color space" convert mode.	#CS-CONVERT out_index,cs_mode<CR>	~nn@CS-CONVERT out_index,cs_mode<CR><LF>	out_index – Number that indicates the specific output: 1-N (N= the total number of outputs) cs_mode – Index in resolution table: 0 – Color space pass (default) 1 – Enable "force RGB color space" convert mode	Enable "force RGB color space" convert mode for channel 1: #CS-CONVERT 1,1<CR>
CS-CONVERT?	Get the "force RGB color space" convert mode.	#CS-CONVERT?_out_index<CR>	~nn@CS-CONVERT out_index,cs_mode<CR><LF>	out_index – Number that indicates the specific output: 1-N (N= the total number of outputs) cs_mode – Index in resolution table: 0 – Color space pass (default) 1 – Enable "force RGB color space" convert mode	Get the "force RGB color space" convert mode status for channel 1: #CS-CONVERT? 1<CR>
EDID-ACTIVE	Activate specific EDID  Only valid in custom mode. in other modes will return error.	#EDID-ACTIVE Input_id, Index<CR>	~nn@EDID-ACTIVE Input_id, Index<CR><LF> or ~nn@EDID-ACTIVE err<CR><LF>	Input_id – 1 Index - Index in EDID List	Set custom EDID #1 active on input 1; If not in CUSTOM mode, return ERROR #EDID-ACTIVE 1,1<CR>
EDID-ACTIVE?	Get current active EDID. Note: only valid in custom mode. in other modes will return error.	#EDID-ACTIVE? Input_id<CR>	~nn@EDID-ACTIVE Input_id, Index<CR><LF>	Input_id – 1 Index - Index in EDID List	Get active custom EDID index on Input 1; If not in CUSTOM mode, return ERROR #EDID-ACTIVE? 1<CR>
EDID-LIST?	Get a list of currently existing EDID's (Get only)	#EDID-LIST?<CR>	~nn@EDID-LIST [port_idx,"name"],...<CR><LF>	port_idx – HDMI port index, only 1 is accepted name – EDID file name	Get EDID list #EDID-LIST?<CR> Return: ~nn@EDID-LIST [0,"DEFAULT"],[2,"SONY"],[5,"PANASONIC"]<CR><LF>
EDID-MODE	Set EDID work mode.	#EDID-MODE Input_id, Mode, Index<CR>	~nn@EDID-MODE Input_id, Mode, Index<CR><LF>	Input_id – 1 Mode: – PASSTHRU (get from decoder) – CUSTOM – DEFAULT Index: for CUSTOM get 'index' from 'EDID-LIST?' command	Set EDID to custom mode, idx is 1 #EDID-MODE 1,CUSTOM,1<CR>
EDID-MODE?	Get EDID work mode.	#EDID-MODE? Input_id<CR>	~nn@EDID-MODE Input_id, Mode, Index<CR><LF>	Input_id – 1 Mode: – PASSTHRU (get from decoder) – CUSTOM – DEFAULT Index: for CUSTOM get 'index' from 'EDID-LIST?' command	Get EDID Mode #EDID-MODE? 1<CR>
EDID-NET-SRC	Set MAC on net device to be EDID source Valid only when EDID-MODE command is set to PASSTHRU	#EDID-NET-SRC input_id, src_ip<CR>	~nn@EDID-NET-SRC input_id, src_ip<CR><LF>	input_id – 1 src_ip – DEC IP address	Set MAC on net device for Input 1 #EDID-NET-SRC 1,192.168.1.40<CR> >
EDID-NET-SRC?	Get MAC on net device of EDID source.	#EDID-NET-SRC? input_id<CR>	~nn@EDID-NET-SRC input_id, src_ip<CR><LF>	input_id – 1 src_ip – DEC IP address	Get MAC on net device for Input 1 #EDID-NET-SRC? 1<CR>
EDID-RM	Remove custom EDID from EDID list Note: should return ERR if this EDID is in USE.	#EDID-RM Index<CR>	~nn@EDID-RM Index<CR><LF> or ~nn@EDID-RM_err<CR><LF>	Index: 1...N - EDID index to remove. Index 0 (default) is not removable	remove EDID from slot 3 and delete the file #EDID-RM 3<CR>
ETH-PORT	Set Ethernet port protocol.  If the port number you enter is already in use, an error is returned. The port number must be within the following range: 0-(2 ¹⁶ -1).	#ETH-PORT_port_type,port_id<CR>	~nn@ETH-PORT port_type,port_id<CR><LF>	port_type – TCP/UDP port_id – when port_type = TCP: 5000-5099 when port_type = UDP: 50000-50999	Set the Ethernet port protocol for TCP to port 12457: #ETH-PORT TCP,5000<CR>
ETH-PORT?	Get Ethernet port protocol.	#ETH-PORT?_port_type<CR>	~nn@ETH-PORT port_type,port_id<CR><LF>	port_type – TCP/UDP port_id – when port_type = TCP: 5000-5099 when port_type = UDP: 50000-50999	

Function	Description	Syntax	Response	Parameters/Attributes	Example
ETH-TUNNEL?	Get an open tunnel parameters.	#ETH-TUNNEL?_tunnel_id<CR>	~nn@ETH-TUNNEL [[tunnel_id,com_id,port_type,port_id,eth_ip,remote_port_id,eth_rep_en,connection_type],...j<CR><LF>	tunnel_id – Tunnel ID number, * (get all open tunnels) com_id – Machine dependent 1 – First COM Port port_type – TCP/UDP 0 – TCP port_id – TCP/UDP port number eth_ip – Client IP address remote_port_id – Remote port number eth_rep_en – Ethernet Reply 0 – COM port does not send replies to new clients 1 – COM port sends replies to new clients connection_type – Connection type 1 – wired connection	Get all open tunnel parameters: #ETH-TUNNEL? *<CR>
FACTORY	Reset device to factory default configuration ⓘ This command deletes all user data from the device. The deletion can take some time. Your device may require powering off and powering on for the changes to take effect.	#FACTORY<CR>	~nn@FACTORY_ok<CR><LF>		Reset the device to factory default configuration: #FACTORY<CR>
GTW-MSG-NUM?	Get Control Gateway Messages Counter from certain period. Add Recv_Count and Send_Count ⓘ <date> is a legacy parameter, for KDS7 and should be ignored.	#GTW-MSG-NUM? message_type,date<CR>	~nn@GTW-MSG-NUM message_type,date,recv_counter,send_count<CR><LF>	message_type – where: 1 =CEC 2 = IR 3 = RS232 date – Format: DD-MM-YYYY. Recv_counter – counter of receive messages Send_counter – counter of send messages	Get Control Gateway Messages Counter from certain period #GTW-MSG-NUM? 1,05-12-2018<CR>
HDCP-MOD	Set HDCP mode. ⓘ Set HDCP working mode on the device input: HDCP supported - HDCP_ON [default]. HDCP not supported - HDCP OFF.	#HDCP-MOD_in_index,mode<CR>	~nn@HDCP-MOD in_index,mode<CR><LF>	in_index – Number that indicates the specific input: 1-N (N= the total number of inputs) mode – HDCP mode: 0 – HDCP Off 1 – HDCP On	Set the input HDCP-MODE of IN 1 to Off: #HDCP-MOD 1,0<CR>
HDCP-MOD?	Get HDCP mode. ⓘ Set HDCP working mode on the device input: HDCP supported - HDCP_ON [default]. HDCP not supported - HDCP OFF. HDCP support changes following detected sink - MIRROR OUTPUT.	#HDCP-MOD?_in_index<CR>	~nn@HDCP-MOD in_index,mode<CR><LF>	in_index – Number that indicates the specific input: 1-N (N= the total number of inputs) mode – HDCP mode: 0 – HDCP Off 1 – HDCP On 3 – HDCP Mirror Mode - used by KDS-7 decoder to allow an HDCP 2.2 source connected to the encoder to play on an HDCP 1.4 TV/display connected to the decoder.	Get the input HDCP-MODE of IN 1 HDMI: #HDCP-MOD? 1<CR>
HDCP-STAT?	Get HDCP signal status. ⓘ io_mode =1 – get the HDCP signal status of the sink device connected to the specified output. io_mode =0 – get the HDCP signal status of the source device connected to the specified input.	#HDCP-STAT? io_mode,in_index<CR>	~nn@HDCP-STAT io_mode,in_index,status<CR><LF>	io_mode – Input/Output 0 – Input 1 – Output io_index – Number that indicates the specific number of inputs or outputs (based on io_mode): 1-N (N=total number of inputs or outputs) status – Signal encryption status - valid values On/Off 0 – HDCP Off 1 – HDCP On	Get the output HDCP-STATUS of IN 1: #HDCP-STAT? 0,1<CR>
HELP	Get command list or help for specific command.	#HELP<CR> #HELP_cmd_name<CR>	1. Multi-line: ~nn@Device_cmd_name, cmd_name<CR><LF>	cmd_name – Name of a specific command	Get the command list: #HELP<CR>
HTTP-AUTH-ENABLE	Start/stop HTTP/HTTPS communication security. ⓘ The HTTP/HTTPS permission works only if security is enabled with the "HTTP-AUTH-ENABLE" command.	#HTTP-AUTH-ENABLE security_state,password<CR>	~nn@HTTP-AUTH-ENABLE security_state<CR><LF>	security_state – Security state 0 – OFF (disables security) 1 – ON (enables security) password – password in uencode64 format, only if the password is valid, AUTH will be disabled otherwise reject the request. ⓘ It is only required when the security_stat is 0 for disabling the security.	Enable the permission system: #HTTP-AUTH-ENABLE 0,dGVzdA==<CR>
HTTP-AUTH-ENABLE?	Get HTTP/HTTPS security state.	#HTTP-AUTH-ENABLE?<CR>	~nn@HTTP-AUTH-ENABLE security_state<CR><LF>	security_state – Security state 0 – OFF (disables security) 1 – ON (enables security)	Get security state: #HTTP-AUTH-ENABLE?<CR>
HTTP-PASSWD	Set password for HTTP user login. The default password is "admin".	#HTTP-PASSWD user,password<CR>	~nn@HTTP-PASSWD user,password<CR><LF>	user – user name of login to set (admin support only). password – Password for the user, in uencode64 format. 8 to 24 characters (letters, numbers, and symbols without spaces or commas), at least including one number, one symbols without spaces or commas, one uppercase letter and one lowercase letter.	Set the password for the admin protocol permission level to test: #HTTP-PASSWD admin,dGVzdA==<CR>

Function	Description	Syntax	Response	Parameters/Attributes	Example
HW-TEMP?	Get device heat	#HW-TEMP? <i>region_id,mode</i> <CR>	~nn@HW-TEMP <i>region_id, temperature</i> <CR><LF>	<i>region_id</i> – ID of the region for which to get the temperature 0 – First CPU <i>Mode</i> – Celsius or Fahrenheit 0 – Celsius 1 – Fahrenheit <i>Temperature</i> – Temperature of the HW region, rounded down to the closest integer	Get temperature in Celsius of first cpu #HW-TEMP? 0,0<CR>
HW-VERSION?	Get hardware version	#HW-VERSION?<CR>	~nn@HW-VERSION <i>hardware_version</i> <CR><LF>	<i>hardware_version</i> – XX.XX.XXXX where the digit groups are: major.minor.version	Get hardware version #HW-VERSION?<CR>
IDV	Set visual indication from device.  Using this command, some devices can light a sequence of buttons or LEDs to allow identification of a specific device from similar devices.	#IDV<CR>	~nn@IDV_ok<CR><LF>		#IDV<CR>
IR-SND	Send IR command to port.	#IR-SND <i>ir_index,sn_id,cmd_name,repeat_amount,total_packages,package_id,< pronto command...></i> <CR>	~nn@IR-SND <i>ir_index,sn_id,cmd_name,ir_status</i> <CR><LF>	<i>ir_index</i> – Number that indicates the specific ir port: 1-N (N= the total number of inputs) * - broadcasts to all ports <i>sn_id</i> – Serial number of command for flow control and response commands from device <i>cmd_name</i> – Command name (length limit 15 chars) <i>repeat_amount</i> – Of times the IR command is transmitted (limited to 50; repeats > 50 are truncated to 50), default = 1 <i>total_packages</i> – Number of messages the original command was divided into, default = 1 <i>package_id</i> – Chunk serial number (only valid when Total_packages >1) <i>pronto_command</i> – Pronto format command (in HEX format, no leading zeros, no '0x' prefix) <i>ir_status</i> – IR Status 0 – Sent (no error) 1 – Stop 2 – Done 3 – Busy 4 – Wrong Parameter 5 – Nothing to Stop 6 – Start 7 – Timeout 8 – Error	Send TVON IR command to IR port 1: #IR-SND 1,1,TVON,1,1,1,00 00,006D,0000,002 2,00ac,00ac,0016, 0040,0016,0040,00 16,0040,0016,0015 ,0016,0015,0016,0 015,0016,0015,001 6,0015,0016,0040, 0016,0040,0016,00 40,0016,0015,0016 ,0015,0016,0015,0 016,0015,0016,001 5,0016,0040,0016, 0015,0016,0015,00 16,0040,0016,0040 ,0016,0015,0016,0 015,0016,0040,001 6,0015,0016,0040, 0016,0040,0016,00 15,0016,0015,0016 ,0040,0016,0040,0 016,0015,0016,071 <<CR>
KDS-ACTION	Set action to perform by encoder/decoder.	#KDS-ACTION <i>kds_mode</i> <CR>	~nn@KDS-ACTION <i>kds_mode</i> <CR><LF>	<i>kds_mode</i> – Action (state) for encoder/decoder 0 – Stop 1 – Play 2 – Save config	Stop the encoder/decoder: #KDS-ACTION 0<CR>
KDS-ACTION?	Get last action (state) performed by encoder/decoder.	#KDS-ACTION?<CR>	~nn@KDS-ACTION <i>kds_mode</i> <CR><LF>	<i>kds_mode</i> – Action (state) for encoder/decoder 0 – Stop 1 – Play 2 – Save config	Get the last action performed by the encoder/decoder: #KDS-ACTION?<CR>
KDS-AUD	Set audio source/destination.	#KDS-AUD <i>mode</i> <CR>	~nn@KDS-AUD <i>mode</i> <CR><LF>	<i>mode</i> – Encoder/decoder audio mode Streamer Audio Encoder 0 – HDMI input 1 – Analog input 2 – None Streamer Audio Decoder 0 – HDMI output 1 – Analog output 2 – Both 3 – None	Set audio source/destination: #KDS-AUD,1<CR>
KDS-AUD?	Get audio source/destination.	#KDS-AUD?<CR>	~nn@KDS-AUD <i>mode</i> <CR><LF>	<i>mode</i> – Encoder/decoder audio mode Streamer Audio Encoder 0 – HDMI input 1 – Analog input 2 – None Streamer Audio Decoder 0 – HDMI output 1 – Analog output 2 – Both 3 – None	Get audio source/destination: #KDS-AUD?<CR>
KDS-DEFINE-CHANNEL	Set Encoder AV channel.	#KDS-DEFINE-CHANNEL <i>ch_id</i> <CR>	~nn@KDS-DEFINE-CHANNEL <i>ch_id</i> <CR><LF>	<i>ch_id</i> – Number that indicates the specific input 1-999.	Tune the encoder: #KDS-DEFINE-CHANNEL,1<CR>
KDS-DEFINE-CHANNEL?	Get Encoder AV channel.	#KDS-DEFINE-CHANNEL?<CR>	~nn@KDS-DEFINE-CHANNEL? <i>ch_id</i> <CR><LF>	<i>ch_id</i> – Number that indicates the specific input 1-999.	Get channel ID: #KDS-DEFINE-CHANNEL?<CR>
KDS-GW-ETH	Set gateway network port	#KDS-GW-ETH <i>gw_type,netw_id</i> <CR>	~nn@KDS-GW-ETH <i>gw_type,netw_id</i> <CR><LF>	<i>gw_type</i> 0 – Control <i>netw_id</i> – Network ID—the device network interface: 0 – Media Port 1 – Service	Set network port gateway to Service #KDS-GW-ETH 0,1<CR>
KDS-GW-ETH?	Get gateway network port.	#KDS-GW-ETH? <i>gw_type</i> <CR>	~nn@KDS-GW-ETH <i>gw_type,netw_id</i> <CR><LF>	<i>gw_type</i> 0 – Control <i>netw_id</i> – Network ID—the device network interface: 0 – Media Port 1 – Service	Get network port gateway port #KDS-GW-ETH? 0<CR>



Function	Description	Syntax	Response	Parameters/Attributes	Example
KDS-METHOD	Set unicast / multicast.	#KDS-METHOD <i>method</i> <CR>	~nn@KDS-METHOD <i>method</i> <CR><LF>	<i>method</i> – Streaming method: 1 – Unicast 2 – Multicast	Set current streaming method of encoder/decoder: #KDS-METHOD 1<CR>
KDS-METHOD?	Get unicast / multicast.	#KDS-METHOD?<CR>	~nn@KDS-METHOD <i>method</i> <CR><LF>	<i>method</i> – Streaming method 1 – Unicast 2 – Multicast	Get current streaming method of encoder/decoder: #KDS-METHOD?<CR>
KDS-MULTICAST	Set multicast group address and TTL value.	#KDS-MULTICAST <i>group_ip,tll</i> <CR>	~nn@KDS-MULTICAST <i>group_ip,tll</i> <CR><LF>	<i>group_ip</i> - Multicast group IP used for streaming packets in Multicast Streaming Method. <i>tll</i> - Time to Live of the streamed packets.	Set multicast group address and TTL value #KDS-MULTICAST 0.0.0.0,64<CR>
KDS-MULTICAST?	Get multicast group address and TTL value.	#KDS-MULTICAST? <CR>	~nn@KDS-MULTICAST <i>group_ip,tll</i> <CR><LF>	<i>group_ip</i> - Multicast group IP used for streaming packets in Multicast Streaming Method. <i>tll</i> - Time to Live of the streamed packets.	Set multicast group address and TTL value #KDS-MULTICAST?<CR>
KDS-RATIO?	Get aspect ratio.	#KDS-RATIO?<CR>	~nn@KDS-RATIO <i>value</i> <CR><LF>	<i>value</i> – Streamer Decoder Aspect Ratio width:height, for example "16:9"	Get Aspect Ratio #KDS-RATIO?<CR>

Function	Description	Syntax	Response	Parameters/Attributes	Example
KDS-RESOL?	Get actual AV stream resolution.	#KDS-RESOL? io_mode,io_index,is_native<CR>	-nn@KDS-RESOL? io_mode,io_index,is_native,resolution<CR><LF>	io_mode – Input/Output 0 – Input 1 – Output io_index – Number that indicates the specific input or output port: 1-N (N= the total number of input or output ports) is_native – Native resolution flag 0 – Off 1 – On resolution – Resolution index 0=No Signal (for input) / Native – EDID (for output) 1=640x480p@59.94Hz/60Hz 2=720x480p@59.94Hz/60Hz 3=720x480p@59.94Hz/60Hz 4=1280x720p@59.94Hz/60Hz 5=1920x1080i@59.94Hz/60Hz 6=720(1440)x480i@59.94Hz/60Hz 7=720(1440)x480i@59.94Hz/60Hz 8=720(1440)x240p@59.94Hz/60Hz 9=720(1440)x240p@59.94Hz/60Hz 10=2880x480i@59.94Hz/60Hz 11=2880x480i@59.94Hz/60Hz 12=2880x240p@59.94Hz/60Hz 13=2880x240p@59.94Hz/60Hz 14=1440x480p@59.94Hz/60Hz 15=1440x480p@59.94Hz/60Hz 16=1920x1080p@59.94Hz/60Hz 17=720x576p@50Hz 18=720x576p@50Hz 19=1280x720p@50Hz 20=1920x1080i@50Hz 21=720(1440)x576i@50Hz 22=720(1440)x576i@50Hz 23=720(1440)x288p@50Hz 24=720(1440)x288p@50Hz 25=2880x576i@50Hz 26=2880x576i@50Hz 27=2880x288p@50Hz 28=2880x288p@50Hz 29=1440x576p@50Hz 30=1440x576p@50Hz 31=1920x1080p@50Hz 32=1920x1080p@23.97Hz/24Hz 33=1920x1080p@25Hz 34=1920x1080p@29.97Hz/30Hz 35=2880x480p@59.94Hz/60Hz 36=2880x480p@59.94Hz/60Hz 37=2880x576p@50Hz 38=2880x576p@50Hz 39=1920x1080i@50Hz 40=1920x1080i@100Hz 41=1280x720p@100Hz 42=720x576p@100Hz 43=720x576p@100Hz 44=720(1440)x576i@100Hz 45=720(1440)x576i@100Hz 46=1920x1080i@119.88/120Hz 47=1280x720p@119.88/120Hz 48=720x480p@119.88/120Hz 49=720x480p@119.88/120Hz 50=720(1440)x480i@119.88/120Hz 51=720(1440)x480i@119.88/120Hz 52=720x576p@200Hz 53=720x576p@200Hz 54=720(1440)x576i@200Hz 55=720(1440)x576i@200Hz 56=720x480p@239.76/240Hz 57=720x480p@239.76/240Hz 58=720(1440)x480i@239.76/240Hz 59=720(1440)x480i@239.76/240Hz 60=1280x720p@23.97Hz/24Hz 61=1280x720p@25Hz 62=1280x720p@29.97Hz/30Hz 63=1920x1080p@119.88/120Hz 64=1920x1080p@100Hz 65=800x600p@60Hz 66=1024x768p@60Hz 67=1280x768p@60Hz 68=1280x1024p@60Hz 69=1600x1200p@60Hz 70=1680x1050p@60Hz 71=1920x1200@60Hz 72=3840x2160p@24Hz 73=3840x2160p@25Hz 74=3840x2160p@30Hz 75=3840x2160p@50Hz 76=3840x2160p@60Hz 77-100=(Reserved) 100=Custom resolution 1 101=Custom resolution 2 102=Custom resolution 3 103=Custom resolution 4 104=Custom resolution 5 104-254=(Reserved)	
KDS-VLAN-TAG	Set vlan tag of gateway port.	#KDS-VLAN-TAG gw_type,tag_id<CR>	-nn@KDS-VLAN-TAG gw_type,tag_id<CR><LF>	gw_type: 0 – Control tag_id – vlan tag (2 to 4093) 1 = No VLAN tag	Set Control vlan tag to 33: #KDS-VLAN-TAG 0,33<CR>
KDS-VLAN-TAG?	Get vlan tag of gateway port.	#KDS-VLAN-TAG? gw_type<CR>	-nn@KDS-VLAN-TAG gw_type,tag_id<CR><LF>	gw_type: 0 – Control tag_id – vlan tag (2 to 4093) 1 = No VLAN tag	Get control vlan tag: #KDS-VLAN-TAG? 0<CR>

Function	Description	Syntax	Response	Parameters/Attributes	Example										
LDFW	Load new firmware file. ① In most devices firmware data is saved to flash memory, but the memory does not update until receiving the "UPGRADE" command and is restarted.	Step 1: #LDFW_size<CR> Step 2: If ready was received, send FIRMWARE_DATA	Response 1: ~nn@LDFW_size ready<CR><LF> or ~nn@LDFW_errnn<CR><LF> Response 2: ~nn@LDFW_size_ok<CR><LF>	size – Size of firmware data that is sent firmware_data – HEX or KFW file in protocol packets Using the Packet Protocol Send a command: LDRV, LOAD, IROUT, LDEDID Receive Ready or ERR### If Ready: a. Send a packet, b. Receive OK on the last packet, c. Receive OK for the command Packet structure: Packet ID (1, 2, 3...) (2 bytes in length) Length (data length + 2 for CRC) – (2 bytes in length) Data (data length -2 bytes) CRC – 2 bytes <table border="1" data-bbox="981 474 1259 562"> <tr> <td>01</td> <td>02</td> <td>03</td> <td>04</td> <td>05</td> </tr> <tr> <td colspan="2">Packet ID</td> <td>Length</td> <td>Data</td> <td>CRC</td> </tr> </table> Response: ~nnnn_ok<CR><LF> (Where NNNN is the received packet ID in ASCII hex digits.)	01	02	03	04	05	Packet ID		Length	Data	CRC	
01	02	03	04	05											
Packet ID		Length	Data	CRC											
LOCK-EDID	Lock last read EDID.	#LOCK-EDID in_index,lock_mode<CR>	~nn@LOCK-EDID in_index,lock_mode<CR><LF>	in_index – 1 lock_mode – On/Off 0 – Off unlocks EDID 1 – On locks EDID	Lock the last read EDID from the HDMI In 1 input #LOCK-EDID 1,1<CR>										
LOCK-EDID?	Get EDID lock state.	#LOCK-EDID? in_index<CR>	~nn@LOCK-EDID in_index,lock_mode<CR><LF>	in_index – 1 lock_mode – On/Off 0 – Off unlocks EDID 1 – On locks EDID	Get EDID lock state for Input 1 #LOCK-EDID? 1<CR>										
LOCK-FP	Lock the front panel.	#LOCK-FP_lock/unlock<CR>	~nn@LOCK-FP lock/unlock<CR><LF>	Lock/Unlock – On/Off 0 – (Off) Unlocks EDID 1 – (On) Locks EDID	Unlock front panel: #LOCK-FP_0<CR>										
LOCK-FP?	Get the front panel lock state.	#LOCK-FP?<CR>	~nn@LOCK-FP lock/unlock<CR><LF>	Lock/Unlock – On/Off Off – Unlocks EDID On – Locks EDID	Get the front panel lock state: #LOCK-FP?<CR>										
LOG-ACTION	Reset events log.	#LOG-ACTION_action,period<CR>	~nn@LOG-ACTION action,period<CR><LF>	action – one of 1 – start (start logging) 2 – pause (pause logging, but keep log content) 3 – resume (resume logging) 4 – reset (clear all current logs, keep logging) period - relevant for "start" 1 – keep current 2 – daily 3 – weekly (default)	Reset events log daily: #LOG-ACTION 4,1<CR>										
LOG-ACTION?	Get log state	#LOG-ACTION?<CR>	~nn@LOG-ACTION action,period<CR><LF>	action – one of 1 – start (start logging) 2 – pause (pause logging, but keep log content) 3 – resume (resume logging) 4 – reset (clear all current logs, keep logging) period - relevant for "start" 1 – keep current 2 – daily 3 – weekly (default)	Get log state: #LOG-ACTION?<CR>										
LOG-TAIL?	Get the last "n" lines of message logs. ① Used for advanced troubleshooting. Helps find error root causes and gets details not displayed in the error code number.	#LOG-TAIL?_line_num<CR>	Get: ~nn@LOG-TAILnn<CR><LF> Line content #1<CR><LF> Line content #2<CR><LF> Etc...	line_num – Optional, default line_num is 10	Get the last "2" lines of message logs: #LOG-TAIL? 2<CR>										





Function	Description	Syntax	Response	Parameters/Attributes	Example
LOGIN	<p>Set protocol permission.</p> <p>ⓘ The permission system works only if security is enabled with the "SECUR" command. LOGIN allows the user to run commands with an End User or Administrator permission level. When the permission system is enabled, LOGIN enables running commands with the User or Administrator permission level. When set, login must be performed upon each connection. It is not mandatory to enable the permission system in order to use the device. In each device, some connections allow logging in to different levels. Some do not work with security at all. Connection may logout after timeout.</p>	#LOGIN login_level,password<CR>	<pre>~nn@LOGIN login_level,password ok<CR><LF> or ~nn@LOGIN_err_004<CR><LF> (if bad password entered)</pre>	<p>login_level – Level of permissions required (User or Admin)</p> <p>password – Predefined password (by PASS command). Default password is an empty string</p>	<pre>Set the protocol permission level to Admin (when the password defined in the PASS command is 33333): #LOGIN admin,33333<CR></pre>
LOGIN?	<p>Get current protocol permission level.</p> <p>ⓘ The permission system works only if security is enabled with the "SECUR" command. For devices that support security, LOGIN allows the user to run commands with an End User or Administrator permission level. In each device, some connections allow logging in to different levels. Some do not work with security at all. Connection may logout after timeout.</p>	#LOGIN?<CR>	<pre>~nn@LOGIN login_level<CR><LF></pre>	<p>login_level – Level of permissions required (User or Admin)</p>	<pre>Get current protocol permission level: #LOGIN?<CR></pre>
LOGOUT	<p>Cancel current permission level.</p> <p>ⓘ Logs out from End User or Administrator permission levels to Not Secure.</p>	#LOGOUT<CR>	<pre>~nn@LOGOUT_ok<CR><LF></pre>		#LOGOUT<CR>
LOGOUT-TIMEOUT	<p>Set inactivity auto-logout time.</p>	# LOGOUT-TIMEOUT time<CR>	<pre>~nn@ LOGOUT-TIMEOUT time<CR><LF></pre>	<p>time – minutes of logout time</p>	<pre>Set Inactivity auto- logout time to 10 #LOGOUT- TIMEOUT 10<CR></pre>
LOGOUT-TIMEOUT?	<p>Get inactivity auto-logout time.</p>	#LOGOUT-TIMEOUT?<CR>	<pre>~nn@LOGOUT-TIMEOUT time<CR><LF></pre>	<p>time – minutes of logout time</p>	<pre>Get Inactivity auto- logout time #LOGOUT- TIMEOUT?<CR></pre>
MODEL?	<p>Get device model.</p> <p>ⓘ This command identifies equipment connected to KDS-SW3-EN7 and notifies of identity changes to the connected equipment. The Matrix saves this data in memory to answer REMOTE-INFO requests.</p>	#MODEL?<CR>	<pre>~nn@MODEL model_name<CR><LF></pre>	<p>model_name – String of up to 19 printable ASCII chars</p>	<pre>Get the device model: #MODEL?<CR></pre>
NAME	<p>Set machine (DNS) name.</p> <p>ⓘ The machine name is not the same as the model name. The machine name is used to identify a specific machine or a network in use (with DNS feature on).</p>	#NAME interface_id, host_name<CR>	<pre>~nn@NAME_interface_id, host_name<CR><LF></pre>	<p>interface_id 0 – machine name</p> <p>host_name – String of up to 15 alphanumeric chars (can include hyphen, not at the beginning or end)</p>	<pre>Set the machine DNS name of the device to room- 442: #NAME 0,room- 442<CR></pre>

Function	Description	Syntax	Response	Parameters/Attributes	Example
NAME?	Get machine (DNS) name. i The machine name is not the same as the model name. The machine name is used to identify a specific machine or a network in use (with DNS feature on).	#NAME? <u>interface_id</u> <CR>	~nn@NAME <u>interface_id</u> / <u>host_name</u> <CR><LF>	<u>interface_id</u> 0 – machine name <u>host_name</u> – String of up to 15 alphanumeric chars (can include hyphen, not at the beginning or end)	Get the DNS name of the device: #NAME? <u>0</u> <CR>
NAME-RST	Reset machine (DNS) name to factory default. i Factory default of machine (DNS) name is "KRAME" + 4 last digits of device serial number.	#NAME-RST<CR>	~nn@NAME-RST_ok<CR><LF>		Reset the machine name (S/N last digits are 0102): #NAME-RST kramer_0102<CR>
NET-CONFIG	Set a network configuration. i For Backward compatibility, the id parameter can be omitted. In this case, the Network ID, by default, is 0, which is the Ethernet control port. i If the gateway address is not compliant to the subnet mask used for the host IP, the command will return an error. Subnet and gateway compliancy specified by RFC950. i This sets the device to DHCP OFF automatically.	#NET-CONFIG <u>netw_id</u> , <u>net_ip</u> , <u>net_mask</u> , <u>gateway</u> <CR>	~nn@NET-CONFIG <u>netw_id</u> , <u>net_ip</u> , <u>net_mask</u> , <u>gateway</u> <CR><LF>	<u>netw_id</u> – Network ID–ID of the Ethernet port 0 – Media Port 1 – Service Port 2 – DANTE Port <u>net_ip</u> – Network IP <u>net_mask</u> – Network mask <u>gateway</u> – Network gateway	Set the device network parameters to IP address 192.168.113.10, net mask 255.255.0.0, and gateway 192.168.0.1: #NET-CONFIG 0,192.168.113.10,255.255.0.0,192.168.0.1<CR>
NET-CONFIG?	Get a network configuration.	#NET-CONFIG? <u>netw_id</u> <CR>	~nn@NET-CONFIG <u>netw_id</u> , <u>net_ip</u> , <u>net_mask</u> , <u>gateway</u> <CR><LF>	<u>netw_id</u> – Network ID–ID of the Ethernet port 0 – Media Port 1 – Service Port 2 – DANTE Port <u>net_ip</u> – Network IP <u>net_mask</u> – Network mask <u>gateway</u> – Network gateway	Get network configuration: #NET-CONFIG? 0<CR>
NET-DHCP	Set DHCP mode. i Only 1 is relevant for the mode value. To disable DHCP, the user must configure a static IP address for the device. Connecting Ethernet to devices with DHCP may take more time in some networks. To connect with a randomly assigned IP by DHCP, specify the device DNS name (if available) using the NAME command. You can also get an assigned IP by direct connection to USB or RS-232 protocol port, if available. For proper settings consult your network administrator. i For Backward compatibility, the id parameter can be omitted. In this case, the Network ID, by default, is 0, which is the Ethernet control port.	#NET-DHCP <u>netw_id</u> , <u>dhcp_state</u> <CR>	~nn@NET-DHCP <u>netw_id</u> , <u>dhcp_state</u> <CR><LF>	<u>netw_id</u> – Network ID–ID of the Ethernet port: 0 – Media Port 1 – Service Port 2 – DANTE Port <u>dhcp_state</u> – 1 – Try to use DHCP. (If unavailable, use the IP address set by the factory or the net-ip command).	Enable DHCP mode for port 1, if available: #NET-DHCP 1,1<CR>
NET-DHCP?	Get DHCP mode i For Backward compatibility, the id parameter can be omitted. In this case, the Network ID, by default, is 0, which is the Ethernet control port.	#NET-DHCP? <u>netw_id</u> <CR>	~nn@NET-DHCP <u>netw_id</u> , <u>dhcp_state</u> <CR><LF>	<u>netw_id</u> – Network ID– ID of the Ethernet port: 0 – Media Port 1 – Service Port 2 – DANTE Port <u>dhcp_state</u> – 1 – Try to use DHCP. (If unavailable, use the IP address set by the factory or the net-ip command).	Get DHCP mode for port 1, if available: #NET-DHCP? 1<CR>
NET-MAC?	Get MAC address.	#NET-MAC?<CR>	~nn@NET-MAC <u>mac_address</u> <CR><LF>	<u>mac_address</u> – Unique MAC address. Format: XX-XX-XX-XX-XX-XX where X is hex digit	#NET-MAC?<CR>

Function	Description	Syntax	Response	Parameters/Attributes	Example
NET-STAT?	Get net connection list of this machine.  The response is returned in one line and terminated with <CR><LF>. The response format lists signal IDs separated by commas. This is an Extended Protocol 3000 command.	#NET-STAT?<CR>	~nn@NET-STAT_[(<port_type>:<port_index>,<client_ip>:<client_port>),state]...<CR><LF>	port_type – TCP/UDP 0 – TCP 1 – UDP port_index – Device port client_ip – Dot-separated representation of the IP address client_port – Client port state – listen or established	Get net connection list of this machine: #NET-STATE?<CR> ~01@NETSTAT [(TCP:80,0.0.0.0:0).LISTEN],[TCP:5000,0.0.0.0:0),LISTEN],[TCP:80,192.168.14.3:52400),ESTABLISHED],[TCP:5000,192.168.1.100:51647).ESTABLISHED]<CR><LF>
NET-IP?	Get a network IP address. This is an UDP protocol only.	#NET-IP?<CR>	~nn@NET-IP_net_ip<CR><LF>	net_ip – Network IP	Get network IP address: #NET-IP?<CR>
PASS	Set password for login level. Default password = admin.	#PASS login_level password<CR>	~nn@PASS login_level,password<CR><LF>	login_level – Level of login to set (supports admin only). password – Password for the login_level. Password should be 8 to 24 characters (including letters, numbers, and symbols without spaces or commas), at least one number, one symbol without spaces or commas, one uppercase letter and one lowercase letter.	Set the password for the admin protocol permission level to Livi4559*: #PASS admin, Livi4559*<CR>
PASS?	Get password for login level. Default password = admin.	#PASS? login_level<CR>	~nn@PASS login_level,password<CR><LF>	login_level – Level of login to set (supports admin only). password – Password for the login_level. Up to 15 printable ASCII chars	Get the password for the admin protocol permission level: #PASS? admin<CR>
PORT-DIRECTION	Set port direction as input or output.	#PORT-DIRECTION <direction_type>.<port_format>.<port_index>.<signal_type>,<direction><CR>	~nn@PORT-DIRECTION <direction_type>.<port_format>.<port_index>.<signal_type>,<direction><CR><LF>	The following attributes comprise the signal ID: <direction_type> – Direction of the port: IN – Input OUT – Output BOTH – Bi-directional <port_format> – Port's signal type: ANALOG-AUDIO IR <port_index> – The port number as printed on the front or rear panel <signal_type> – Signal ID attribute: AUDIO IR <direction> – Port direction: IN – Input OUT – Output	Set audio analog port direction as input #PORT-DIRECTION both.analog.1.audio, IN<CR>
PORT-DIRECTION?	Get port direction.	#PORT-DIRECTION? <direction_type>.<port_format>.<port_index>.<signal_type><CR>	~nn@PORT-DIRECTION <direction_type>.<port_format>.<port_index>.<signal_type>,<direction><CR><LF>	The following attributes comprise the signal ID: <direction_type> – Direction of the port: IN – Input OUT – Output BOTH – Bi-directional } <port_format> –Port's signal type: ANALOG-AUDIO IR <port_index> – The port number as printed on the front or rear panel <signal_type> – Signal ID attribute: AUDIO IR <direction> – Port direction: IN – Input OUT – Output	Get audio analog port direction #PORT-DIRECTION? both.analog.1.audio<CR>
PORTS-LIST?	Get the port list of this machine.  The response is returned in one line and terminated with <CR><LF>. The response format lists port IDs separated by commas. This is an Extended Protocol 3000 command.	#PORTS-LIST?<CR>	~nn@PORTS-LIST [<direction_type>.<port_format>.<port_index>,...]<CR><LF>	The following attributes comprise the port ID: <direction_type> – Direction of the port: IN OUT BOTH <port_format> – Type of signal on the port: HDMI ANALOG_AUDIO RS-232 IR USB_A USB_B USB_C STREAM <port_index> – The port number as printed on the front or rear panel.	Get the ports list: #PORTS-LIST?<CR>

Function	Description	Syntax	Response	Parameters/Attributes	Example
RESET	Reset device ⓘ To avoid locking the port due to a USB bug in Windows, disconnect USB connections immediately after running this command. If the port was locked, disconnect and reconnect the cable to reopen the port.	#RESET<CR>	~nn@RESET,ok<CR><LF>		Reset the device: #RESET<CR>
ROLLBACK	Rollback firmware to standby version.	#ROLLBACK<CR>	~nn@ROLLBACK,ok<CR><LF>		Perform firmware rollback: # ROLLBACK<CR>
SECUR	Start/stop P3K communication security. ⓘ The permission system works only if security is enabled with the "SECUR" command.	#SECUR,security_state<CR>	~nn@SECUR,security_state<CR><LF>	security_state – Security state 0 – OFF (disables security) 1 – ON (enables security)	Enable the permission system: #SECUR,0<CR>
SECUR?	Get P3K security state.	#SECUR?<CR>	~nn@SECUR,security_state<CR><LF>	security_state – Security state 0 – OFF (disables security) 1 – ON (enables security)	Get security state: #SECUR?<CR>
SIGNALS-LIST?	Get signal ID list of this machine. ⓘ The response is returned in one line and terminated with<CR><LF>. The response format lists signal IDs separated by commas. This is an Extended Protocol 3000 command.	#SIGNALS-LIST?<CR><LF>	~nn@SIGNALS-LIST [<direction_type>,<port_format>,<port_label>,<signal_type>,<index>,<index>,<CR><LF>	The following attributes comprise the signal ID: <direction_type> – Direction of the port: IN – Input OUT – Output BOTH – Bi-directional (e.g. for RS-232) <port_format> – Type of signal on the port: HDMI ANALOG_AUDIO RS-232 IR USB_A USB_B USB_C STREAM <port_index> – The port number as printed on the front or rear panel <signal_type> – Signal ID attribute: VIDEO AUDIO RS232 IR USB <index> – Indicates a specific channel number when there are multiple channels of the same type	Get signal ID list: #SIGNALS-LIST?<CR>
SN?	Get device serial number.	#SN?<CR>	~nn@SN,serial_num<CR><LF>	serial_num – 14 decimal digits, factory assigned	Get the device serial number: #SN?<CR>
STANDBY-VERSION?	Get standby firmware version.	#STANDBY-VERSION?<CR>	~nn@STANDBY-VERSION?,standby_version<CR><LF>	standby_version – XX.XX.XXXX where the digit groups are: major.minor.build version	Get standby version #STANDBY-VERSION?<CR>
TIME	Set device time and date.. ⓘ The year must be 4 digits. The device does not validate the day of week from the date. Time format - 24 hours. Date format - Day, Month, Year.	#TIME,day_of_week,date,data<CR>	~nn@TIME,day_of_week,date,data<CR><LF>>	day_of_week – One of {SUN,MON,TUE,WED,THU,FRI,SAT} date – Format: DD-MM-YYYY. data – Format: hh:mm:ss where	Set device time and date to December 5, 2018 at 2:30pm: #TIME,mon_05-12-2018,14:30:00<CR>>
TIME?	Get device time and date.. ⓘ The year must be 4 digits. The device does not validate the day of week from the date. Time format - 24 hours. Date format - Day, Month, Year.	#TIME?<CR>	~nn@TIME,day_of_week,date,data<CR><LF>>	day_of_week – One of {SUN,MON,TUE,WED,THU,FRI,SAT} date – Format: YYYY/MM/DD where data – Format: hh:mm:ss where	Get device time and date: #TIME?<CR>

Function	Description	Syntax	Response	Parameters/Attributes	Example
TIME-LOC	<p>Set local time offset from UTC/GMT.</p> <p>ⓘ If the time server is configured, device time calculates by adding UTC_off to UTC time (that it got from the time server) + 1 hour if daylight savings time is in effect. TIME command sets the device time without considering these settings.</p> <p>ⓘ Daylight saving time is not supported.</p> <p>ⓘ Restart the unit to take effect.</p>	#TIME-LOC,utc_off,dst_state<CR>	~nn@TIME-LOC utc_off,dst_state<CR><LF>	<p>utc_off – Offset of device time from UTC/GMT (without daylight time correction), format hh:mm (mm is optional).</p> <p>dst_state – Daylight saving time state 0 – no daylight saving time</p>	<p>Set local time offset to 3 with no daylight-saving time: #TIME-LOC 3,0<CR> or #TIME-LOC 03:00,0<CR></p>
TIME-LOC?	<p>Get local time offset from UTC/GMT.</p> <p>ⓘ If the time server is configured, device time calculates by adding UTC_off to UTC time (that it got from the time server) + 1 hour if daylight savings time is in effect. TIME command sets the device time without considering these settings.</p> <p>ⓘ Daylight saving time is not supported.</p>	#TIME-LOC?<CR>	~nn@TIME-LOC utc_off,dst_state<CR><LF>	<p>utc_off – Offset of device time from UTC/GMT (without daylight time correction), format hh:mm (mm is optional).</p> <p>dst_state – Daylight saving time state 0 – no daylight saving time</p>	<p>Get local time offset from UTC/GMT: #TIME-LOC?<CR></p>
TIME-SRV	<p>Set time server.</p> <p>ⓘ This command is needed for setting UDP timeout for the current client list.</p>	#TIME-SRV mode,time_server_ip,sync_hour<CR> >	~nn@TIME-SRV mode,time_server_ip,sync_hour, server_status<CR><LF>	<p>mode – On/Off 0 – Off 1 – On time_server_ip – Time server IP address sync_hour – Hour in day for time server sync server_status – On/Off</p>	<p>Set time server with IP address of 128.138.140.44 to ON: #TIME-SRV 1,128.138.140.44,0 ,1<CR></p>
TIME-SRV?	<p>Get time server.</p> <p>ⓘ This command is needed for setting UDP timeout for the current client list.</p>	#TIME-SRV?<CR>	~nn@TIME-SRV mode,time_server_ip,sync_hour, server_status<CR><LF>	<p>mode – On/Off 0 – Off 1 – On time_server_ip – Time server IP address sync_hour – Hour in day for time server sync server_status – On/Off</p>	<p>Get time server: #TIME-SRV?<CR></p>
UART	<p>Set com port configuration. If Serial is configured when RS-485 is selected, the RS-485 UART port automatically changes. The command is backward compatible, meaning that if the extra parameters do not exist, FW goes to RS-232. Stop_bits 1.5 is only relevant for 5 data_bits.</p>	#UART com_id,baud_rate,data_bits,parity,stop_bits_mode,serial_type,485_term<CR>	~nn@UART com_id,baud_rate,data_bits,parity,stop_bits_mode,serial_type,485_term<CR><LF>	<p>com_id – 1 to n (machine dependent) baud_rate – 9600 - 115200 data_bits – 5-8 parity – Parity Type 0 – No 1 – Odd 2 – Even stop_bits_mode – 1/1.5/2 serial_type – 232/485 0 – 232 1 – 485 485_term – 485 termination state 0 – disable 1 – enable (optional - this exists only when serial_type is 485)</p>	<p>Set baud rate to 9600, 8 data bits, parity to none and stop bit to 1: #UART 9600,8,node,1<CR> ></p>
UART?	<p>Get com port configuration. The command is backward compatible, meaning that if the extra parameters do not exist, FW goes to RS-232. Stop_bits 1.5 is only relevant for 5 data_bits.</p>	#UART?,com_id<CR>	~nn@UART com_id,baud_rate,data_bits,parity,stop_bits_mode,serial_type,485_term<CR><LF>	<p>com_id – 1 to n (machine dependent) baud_rate – 9600 - 115200 data_bits – 5-8 parity – Parity Type 0 – No 1 – Odd 2 – Even stop_bits_mode – 1/1.5/2 serial_type – 232/485 0 – 232 1 – 485 485_term – 485 termination state 0 – disable 1 – enable (optional - this exists only when serial_type is 485)</p>	<p>Set baud rate to 9600, 8 data bits, parity to none and stop bit to 1: #UART 1,9600,8,node,1<CR> R></p>
UPG-TIME?	<p>Get firmware version last upgrade date/time Add New Command for KDS-7</p>	#UPG-TIME?<CR>	~nn@UPG-TIME date,data<CR><LF>	<p>date – Format: DD-MM-YYYY. data – Format: hh:mm:ss where</p>	<p>Get last upgrade date/time #UPG-TIME?<CR></p>
UPGRADE	<p>Perform firmware upgrade.</p> <p>ⓘ Not necessary for some devices. Firmware usually uploads to a device via a command like LDFW. Reset the device to complete the process.</p>	#UPGRADE<CR>	~nn@UPGRADE,ok<CR><LF>		<p>Perform firmware upgrade: #UPGRADE<CR></p>

Function	Description	Syntax	Response	Parameters/Attributes	Example
VERSION?	Get firmware version number.	#VERSION?<CR>	~nn@VERSION firmware_version<CR><LF>	firmware_version – XX.XX.XXXX where the digit groups are: major.minor.build version	Get the device firmware version number: #VERSION?<CR>
X-AUD-DESC?	Get audio signal info  This is an Extended Protocol 3000 command.	#X-AUD-DESC? <direction_type>.<port_format>.<port_index><CR>	~nn@X-AUD-DESC? <direction_type>.<port_format>.<port_label>.<signal_type>.<index>.<ch_tot,samp_rate,aud_format><CR><LF>	The following attributes comprise the signal ID: <direction_type> – Direction of the port: IN – Input OUT – Output BOTH – Bi-directional (e.g. for RS-232) <port_format> – Type of signal on the port: HDMI ANALOG_AUDIO STREAM DANTE <port_index> – The port number as printed on the front or rear panel <signal_type> – Signal ID attribute: AUDIO <index> – Indicates a specific channel number when there are multiple ch_tot – Total number of channels • samp_rate – Sample rate • aud_format – Audio Format: • LPCM – Linear Pulse Code Modulation audio • Non-LPCM – None Linear Pulse Code Modulation audio, like Dolby Digital, DTS, etc. • HBR – High Bitrate Audio, like Dolby TrueHD, DTS HD Master Audio	Get the audio signal info: #X-AUD-DESC? out.hdmi.1<CR>
X-AUD-LVL	Set audio level of a specific signal.  This is an Extended Protocol 3000 command.	#X-AUD-LVL <direction_type>.<port_format>.<port_index>.<signal_type>.<index>.<audio_level><CR>	~nn@X-AUD-LVL <direction_type>.<port_format>.<port_index>.<signal_type>.<index>.<audio_level><CR><LF>	The following attributes comprise the signal ID: <direction_type> – Direction of the port: OUT – Output <port_format> – Type of signal on the port: ANALOG_AUDIO <port_index> – The port number as printed on the front or rear panel <signal_type> – Signal ID attribute: AUDIO <index> – Indicates a specific channel number when there are multiple channels of the same type audio_level – Audio level (range between 0 to 100)	Set the audio level of a specific signal to 10: #X-AUD-LVL in.analog_audio.5.audio.1,10<CR>
X-AUD-LVL?	Get audio level of a specific signal.  This is an Extended Protocol 3000 command.	#X-AUD-LVL? <direction_type>.<port_format>.<port_index>.<signal_type>.<index>.<audio_level><CR>	~nn@X-AUD-LVL <direction_type>.<port_format>.<port_index>.<signal_type>.<index>.<audio_level><CR><LF>	The following attributes comprise the signal ID: <direction_type> – Direction of the port: OUT – Output <port_format> – Type of signal on the port: ANALOG_AUDIO <port_index> – The port number as printed on the front or rear panel <signal_type> – Signal ID attribute: AUDIO <index> – Indicates a specific channel number when there are multiple channels of the same type audio_level – Audio level (range between 0 to 100)	Get the audio level of a specific signal: #X-AUD-LVL? out.analog_audio.1.audio.1<CR>
X-AV-SW-MODE	Set auto-switch mode per output.  This is an Extended Protocol 3000 command.	#X-AV-SW-MODE <direction_type>.<port_format>.<port_index>.<signal_type>.<index>.<connection_mode><CR>	~nn@X-AV-SW-MODE <direction_type>.<port_format>.<port_index>.<signal_type>.<index>.<connection_mode><CR><LF>	The following attributes comprise the signal ID: <direction_type> – Direction of the port: OUT – Output <port_format> – Type of signal on the port: HDMI ANALOG_AUDIO STREAM <port_index> – The port number as printed on the front or rear panel <signal_type> – Signal ID attribute: VIDEO AUDIO <index> – Indicates a specific channel number when there are multiple channels of the same type connection_mode – Connecton mode 0 – manual 1 – priority 2 – last connected	Set auto switch mode for HDMI OUT 1 (last connected): #X-AV-SW-MODE out.hdmi.1.video.1,2<CR>

Function	Description	Syntax	Response	Parameters/Attributes	Example
X-AV-SW-MODE?	Get auto-switch mode.  This is an Extended Protocol 3000 command.	#X-AV-SW-MODE?<direction_type>.<port_format>.<port_index>.<signal_type>.<index><CR>	~nn@X-AV-SW-MODE <direction_type>.<port_format>.<port_index>.<signal_type>.<index>.<connection_mode><CR><LF>	The following attributes comprise the signal ID: <direction_type> – Direction of the port: OUT – Output <port_format> – Type of signal on the port: HDMI ANALOG_AUDIO STREAM <port_index> – The port number as printed on the front or rear panel <signal_type> – Signal ID attribute: VIDEO AUDIO <index> – Indicates a specific channel number when there are multiple channels of the same type connection_mode – Connecton mode 0 – manual 1 – priority 2 – last connected	Get auto switch mode for HDMI OUT 1: #X-AV-SW-MODE? out.hdmi.1.video.1<CR>
X-MUTE	Set mute ON/OFF on a specific signal.	#X-MUTE <direction_type>.<port_format>.<port_index>.<signal_type>.<index>.state<CR>	~nn@ X-MUTE <direction_type>.<port_format>.<port_index>.<signal_type>.<index>.state<CR><LF>	<direction_type> – Direction of port: OUT – Output <port_format> – Type of signal on the port: HDMI ANALOG_AUDIO STREAM ALL-All audio output <port_index> – The port number as printed on the front or rear panel. <signal_type> – Signal ID attribute: AUDIO <index> – Indicates a specific channel number when there are multiple channels of the same type state – OFF/ON (not case sensitive)	Mute the video on HDMI OUT 1: #X-MUTE_out.hdmi.1.video.1,on<CR> Mute the audio on ALL OUT: #X-MUTE out.all.1.audio.1,on<CR>
X-MUTE?	Get mute ON/OFF on a specific signal.	#X-MUTE? <direction_type>.<port_format>.<port_index>.<signal_type>.<index><CR>	~nn@ X-MUTE <direction_type>.<port_format>.<port_index>.<signal_type>.<index>.state<CR><LF>	<direction_type> – Direction of the port: OUT – Output <port_format> – Type of signal on the port: HDMI ANALOG_AUDIO STREAM ALL – All audio ouput. <port_index> – The port number as printed on the front or rear panel. <signal_type> – Signal ID attribute: AUDIO <index> – Indicates a specific channel number when there are multiple channels of the same type state – OFF/ON (not case sensitive)	Get the mute the video on HDMI OUT 1: #X-MUTE?_out.hdmi.1.video.1<CR>
X-PRIORITY	Set priority order.	#X-PRIORITY <direction_type>.<port_format>.<port_index>.<signal_type>.[<direction_type>.<port_format>.<port_index>.<signal_type>]...<CR>	~nn@X-PRIORITY <direction_type>.<port_format>.<port_index>.<signal_type>.[<direction_type>.<port_format>.<port_index>.<signal_type>]...<CR><LF>	<direction_type> – Direction of the port: IN – Input OUT – Output <port_format> – Type of signal on the port: HDMI USB_C ANALOG_AUDIO STREAM <port_index> – The port number as printed on the front or rear panel. <signal_type> – Signal ID attribute: VIDEO AUDIO	Set video priority is 3,2,1 #X-PRIORITY out.hdmi.1.video.[in.usb_c.3.video.in.hdmi.2.video.in.hdmi.1.video]<CR>
X-PRIORITY?	Get priority order.	#X-PRIORITY? <direction_type>.<port_format>.<port_index>.<signal_type><CR>	~nn@X-PRIORITY <direction_type>.<port_format>.<port_index>.<signal_type>.[<direction_type>.<port_format>.<port_index>.<signal_type>]...<CR><LF>	<direction_type> – Direction of the port: IN – Input OUT – Output <port_format> – Type of signal on the port: HDMI USB_C ANALOG_AUDIO STREAM <port_index> – The port number as printed on the front or rear panel. <signal_type> – Signal ID attribute: VIDEO AUDIO	Get video priority #X-PRIORITY? out.hdmi.1.video<CR>

Function	Description	Syntax	Response	Parameters/Attributes	Example
X-ROUTE	<p>Send routing command.</p> <p>① It is recommended to use the command #SIGNALS-LIST to get the list of all signal IDs available in the system and which can be used in this command.</p> <p>Video 1 is the default port in this command and is implied even if not written:</p> <pre>#X-ROUTE out.hdmi.1,in.hdmi.1<CR></pre> <p>is interpreted as:</p> <pre>#X-ROUTE out.hdmi.1.video.1,in.hdmi.1.video.1<CR></pre> <p>This is an Extended Protocol 3000 command. Brackets '[' and ']' are reserved Protocol 3000 characters that define a list of parameters as in [a,b,c,d].</p>	<pre>#X-ROUTE [<direction_type1>.<port_type1>.<port_index1>.<signal_type1>.<index1>,<direction_type2>.<port_type2>.<port_index2>.<signal_type2>.<index2><CR></pre>	<pre>~nn@X-ROUTE [<direction_type1>.<port_type1>.<port_index1>.<signal_type1>.<index1>,<direction_type2>.<port_type2>.<port_index2>.<signal_type2>.<index2><CR><LF></pre>	<p>The following attributes comprise the signal ID:</p> <p><direction_type> – Direction of the port:</p> <p>IN – Input OUT – Output BOTH – Bi-directional (e.g. for RS-232)</p> <p><port_format> – Type of signal on the port:</p> <p>HDMI ANALOG_AUDIO STREAM DANTE – Only available on KDS-SW3-EN7</p> <p><port_index> – The port number as printed on the front or rear panel</p> <p><signal_type> – Signal ID attribute:</p> <p>VIDEO AUDIO</p> <p><index> – Indicates a specific channel number when there are multiple channels of the same type</p>	<p>Route HDMI IN 2 to HDMI OUT 1:</p> <pre>#X-ROUTE out.hdmi.1.video.1,in.hdmi.2.video.1<CR></pre> <p>Route audio of hdmi.1.audio.1 signal to hdmi output, analog, and dante:</p> <pre>#X-ROUTE [out.hdmi.1.audio.1.out.analog_audio.1.audio.1.out.dante.1.audio.1],in.hdmi.1.audio.1<CR></pre>
X-ROUTE?	<p>Get routing status.</p> <p>NOTE: It is recommended to use the command #SIGNALS-LIST to get the list of all signal IDs available in the system and which can be used in this command.</p> <p>VIDEO.1 are the default <signal_type> and <index> in this command and are implied even if not written:</p> <pre>#X-ROUTE? out.hdmi.1<CR></pre> <p>is interpreted as:</p> <pre>#X-ROUTE? out.hdmi.1.video.1<CR></pre> <p>This is an Extended Protocol 3000 command.</p>	<pre>#X-ROUTE? <direction_type1>.<port_type1>.<port_index1>.<signal_type1>.<index1><CR></pre>	<pre>~nn@X-ROUTE <direction_type1>.<port_type1>.<port_index1>.<signal_type1>.<index1>,<direction_type2>.<port_type2>.<port_index2>.<signal_type2>.<index2><CR><LF></pre>	<p>The following attributes comprise the signal ID:</p> <p><direction_type> – Direction of the port:</p> <p>IN – Input OUT – Output BOTH – Bi-directional (e.g. for RS-232)</p> <p><port_format> – Type of signal on the port:</p> <p>HDMI ANALOG_AUDIO STREAM DANTE – Only available on KDS-SW3-EN7</p> <p><port_index> – The port number as printed on the front or rear panel</p> <p><signal_type> – Signal ID attribute:</p> <p>VIDEO AUDIO</p> <p><index> – Indicates a specific channel number when there are multiple channels of the same type</p>	<p>Get the routing status:</p> <pre>#X-ROUTE? out.hdmi.1.video.1<CR></pre>

Result and Error Codes

Syntax

In case of an error, the device responds with an error message. The error message syntax:

- **~NN@ERR XXX<CR><LF>** – when general error, no specific command
- **~NN@CMD ERR XXX<CR><LF>** – for specific command
- **NN** – machine number of device, default = 01
- **XXX** – error code

Error Codes

Error Name	Error Code	Description
P3K_NO_ERROR	0	No error
ERR_PROTOCOL_SYNTAX	1	Protocol syntax
ERR_COMMAND_NOT_AVAILABLE	2	Command not available
ERR_PARAMETER_OUT_OF_RANGE	3	Parameter out of range
ERR_UNAUTHORIZED_ACCESS	4	Unauthorized access
ERR_INTERNAL_FW_ERROR	5	Internal FW error
ERR_BUSY	6	Protocol busy
ERR_WRONG_CRC	7	Wrong CRC
ERR_TIMEDOUT	8	Timeout
ERR_RESERVED	9	(Reserved)
ERR_FW_NOT_ENOUGH_SPACE	10	Not enough space for data (firmware, FPGA...)
ERR_FS_NOT_ENOUGH_SPACE	11	Not enough space – file system
ERR_FS_FILE_NOT_EXISTS	12	File does not exist
ERR_FS_FILE_CANT_CREATED	13	File can't be created
ERR_FS_FILE_CANT_OPEN	14	File can't open
ERR_FEATURE_NOT_SUPPORTED	15	Feature is not supported
ERR_RESERVED_2	16	(Reserved)
ERR_RESERVED_3	17	(Reserved)
ERR_RESERVED_4	18	(Reserved)
ERR_RESERVED_5	19	(Reserved)
ERR_RESERVED_6	20	(Reserved)
ERR_PACKET_CRC	21	Packet CRC error
ERR_PACKET_MISSED	22	Packet number isn't expected (missing packet)
ERR_PACKET_SIZE	23	Packet size is wrong
ERR_RESERVED_7	24	(Reserved)
ERR_RESERVED_8	25	(Reserved)
ERR_RESERVED_9	26	(Reserved)
ERR_RESERVED_10	27	(Reserved)
ERR_RESERVED_11	28	(Reserved)
ERR_RESERVED_12	29	(Reserved)
ERR_EDID_CORRUPTED	30	EDID corrupted
ERR_NON_LISTED	31	Device specific errors
ERR_SAME_CRC	32	File has the same CRC – not changed
ERR_WRONG_MODE	33	Wrong operation mode
ERR_NOT_CONFIGURED	34	Device/chip was not initialized

The warranty obligations of Kramer Electronics Inc. ("Kramer Electronics") for this product are limited to the terms set forth below:

What is Covered

This limited warranty covers defects in materials and workmanship in this product.

What is Not Covered

This limited warranty does not cover any damage, deterioration or malfunction resulting from any alteration, modification, improper or unreasonable use or maintenance, misuse, abuse, accident, neglect, exposure to excess moisture, fire, improper packing and shipping (such claims must be presented to the carrier), lightning, power surges, or other acts of nature. This limited warranty does not cover any damage, deterioration or malfunction resulting from the installation or removal of this product from any installation, any unauthorized tampering with this product, any repairs attempted by anyone unauthorized by Kramer Electronics to make such repairs, or any other cause which does not relate directly to a defect in materials and/or workmanship of this product. This limited warranty does not cover cartons, equipment enclosures, cables or accessories used in conjunction with this product.

Without limiting any other exclusion herein, Kramer Electronics does not warrant that the product covered hereby, including, without limitation, the technology and/or integrated circuit(s) included in the product, will not become obsolete or that such items are or will remain compatible with any other product or technology with which the product may be used.

How Long this Coverage Lasts

The standard limited warranty for Kramer products is seven (7) years from the date of original purchase, with the following exceptions:

1. All Kramer VIA hardware products are covered by a standard three (3) year warranty for the VIA hardware and a standard three (3) year warranty for firmware and software updates; all Kramer VIA accessories, adapters, tags, and dongles are covered by a standard one (1) year warranty.
2. Kramer fiber optic cables, adapter-size fiber optic extenders, pluggable optical modules, active cables, cable retractors, ring mounted adapters, portable power chargers, Kramer speakers, and Kramer touch panels are covered by a standard one (1) year warranty. Kramer 7-inch touch panels purchased on or after April 1st, 2020 are covered by a standard two (2) year warranty.
3. All Kramer Calibre products, all Kramer Minicom digital signage products, all HighSecLabs products, all streaming, and all wireless products are covered by a standard three (3) year warranty.
4. All Sierra Video MultiViewers are covered by a standard five (5) year warranty.
5. Sierra switchers & control panels are covered by a standard seven (7) year warranty (excluding power supplies and fans that are covered for three (3) years).
6. K-Touch software is covered by a standard one (1) year warranty for software updates.
7. All Kramer passive cables are covered by a lifetime warranty.

Who is Covered

Only the original purchaser of this product is covered under this limited warranty. This limited warranty is not transferable to subsequent purchasers or owners of this product.

What Kramer Electronics Will Do

Kramer Electronics will, at its sole option, provide one of the following three remedies to whatever extent it shall deem necessary to satisfy a proper claim under this limited warranty:

1. Elect to repair or facilitate the repair of any defective parts within a reasonable period of time, free of any charge for the necessary parts and labor to complete the repair and restore this product to its proper operating condition. Kramer Electronics will also pay the shipping costs necessary to return this product once the repair is complete.
2. Replace this product with a direct replacement or with a similar product deemed by Kramer Electronics to perform substantially the same function as the original product. If a direct or similar replacement product is supplied, the original product's end warranty date remains unchanged and is transferred to the replacement product.
3. Issue a refund of the original purchase price less depreciation to be determined based on the age of the product at the time remedy is sought under this limited warranty.

What Kramer Electronics Will Not Do Under This Limited Warranty

If this product is returned to Kramer Electronics or the authorized dealer from which it was purchased or any other party authorized to repair Kramer Electronics products, this product must be insured during shipment, with the insurance and shipping charges prepaid by you. If this product is returned uninsured, you assume all risks of loss or damage during shipment. Kramer Electronics will not be responsible for any costs related to the removal or re-installation of this product from or into any installation. Kramer Electronics will not be responsible for any costs related to any setting up this product, any adjustment of user controls or any programming required for a specific installation of this product.

How to Obtain a Remedy Under This Limited Warranty

To obtain a remedy under this limited warranty, you must contact either the authorized Kramer Electronics reseller from whom you purchased this product or the Kramer Electronics office nearest you. For a list of authorized Kramer Electronics resellers and/or Kramer Electronics authorized service providers, visit our web site at www.kramerav.com or contact the Kramer Electronics office nearest you.

In order to pursue any remedy under this limited warranty, you must possess an original, dated receipt as proof of purchase from an authorized Kramer Electronics reseller. If this product is returned under this limited warranty, a return authorization number, obtained from Kramer Electronics, will be required (RMA number). You may also be directed to an authorized reseller or a person authorized by Kramer Electronics to repair the product.

If it is decided that this product should be returned directly to Kramer Electronics, this product should be properly packed, preferably in the original carton, for shipping. Cartons not bearing a return authorization number will be refused.

Limitation of Liability

THE MAXIMUM LIABILITY OF KRAMER ELECTRONICS UNDER THIS LIMITED WARRANTY SHALL NOT EXCEED THE ACTUAL PURCHASE PRICE PAID FOR THE PRODUCT. TO THE MAXIMUM EXTENT PERMITTED BY LAW, KRAMER ELECTRONICS IS NOT RESPONSIBLE FOR DIRECT, SPECIAL, INCIDENTAL OR CONSEQUENTIAL DAMAGES RESULTING FROM ANY BREACH OF WARRANTY OR CONDITION, OR UNDER ANY OTHER LEGAL THEORY. Some countries, districts or states do not allow the exclusion or limitation of relief, special, incidental, consequential or indirect damages, or the limitation of liability to specified amounts, so the above limitations or exclusions may not apply to you.

Exclusive Remedy

TO THE MAXIMUM EXTENT PERMITTED BY LAW, THIS LIMITED WARRANTY AND THE REMEDIES SET FORTH ABOVE ARE EXCLUSIVE AND IN LIEU OF ALL OTHER WARRANTIES, REMEDIES AND CONDITIONS, WHETHER ORAL OR WRITTEN, EXPRESS OR IMPLIED. TO THE MAXIMUM EXTENT PERMITTED BY LAW, KRAMER ELECTRONICS SPECIFICALLY DISCLAIMS ANY AND ALL IMPLIED WARRANTIES, INCLUDING, WITHOUT LIMITATION, WARRANTIES OF MERCHANTABILITY AND FITNESS FOR A PARTICULAR PURPOSE. IF KRAMER ELECTRONICS CANNOT LAWFULLY DISCLAIM OR EXCLUDE IMPLIED WARRANTIES UNDER APPLICABLE LAW, THEN ALL IMPLIED WARRANTIES COVERING THIS PRODUCT, INCLUDING WARRANTIES OF MERCHANTABILITY AND FITNESS FOR A PARTICULAR PURPOSE, SHALL APPLY TO THIS PRODUCT AS PROVIDED UNDER APPLICABLE LAW. IF ANY PRODUCT TO WHICH THIS LIMITED WARRANTY APPLIES IS A "CONSUMER PRODUCT" UNDER THE MAGNUSON-MOSS WARRANTY ACT (15 U.S.C.A. §2301, ET SEQ.) OR OTHER APPLICABLE LAW, THE FOREGOING DISCLAIMER OF IMPLIED WARRANTIES SHALL NOT APPLY TO YOU, AND ALL IMPLIED WARRANTIES ON THIS PRODUCT, INCLUDING WARRANTIES OF MERCHANTABILITY AND FITNESS FOR THE PARTICULAR PURPOSE, SHALL APPLY AS PROVIDED UNDER APPLICABLE LAW.

Other Conditions

This limited warranty gives you specific legal rights, and you may have other rights which vary from country to country or state to state.

This limited warranty is void if (i) the label bearing the serial number of this product has been removed or defaced, (ii) the product is not distributed by Kramer Electronics or (iii) this product is not purchased from an authorized Kramer Electronics reseller. If you are unsure whether a reseller is an authorized Kramer Electronics reseller, visit our web site at www.kramerav.com or contact a Kramer Electronics office from the list at the end of this document.

Your rights under this limited warranty are not diminished if you do not complete and return the product registration form or complete and submit the online product registration form. Kramer Electronics thanks you for purchasing a Kramer Electronics product. We hope it will give you years of satisfaction.



SAFETY WARNING

Disconnect the unit from the power supply before opening and servicing

For the latest information on our products and a list of Kramer distributors, visit our website where updates to this user manual may be found.

We welcome your questions, comments, and feedback.

The terms HDMI, HDMI High-Definition Multimedia Interface, and the HDMI Logo are trademarks or registered trademarks of HDMI Licensing Administrator, Inc. All brand names, product names, and trademarks are the property of their respective owners.