



Poly TC10

Administrator Guide

4.0.0 | November 2022 | 3725-13687-001A

Contents

Before You Begin	4
Audience, Purpose, and Required Skills	4
Product Terminology Used in This Guide	4
Related Poly and Partner Resources	4
Getting Started	5
Poly TC10 Overview	5
Poly TC10 in Poly Video Mode as a Room Controller	5
Poly TC10 in Zoom Rooms Mode	5
Poly TC10 Hardware Overview	7
Poly TC10 Local Interface	8
Poly TC10 Status Bars	8
Home Screen in Poly Video Mode	8
Access the Poly Control Center	9
Waking the Poly TC10	9
Accessibility Features	10
Users Who Are Deaf or Hard of Hearing	10
Users Who Are Blind, Have Low Vision, or Have Limited Vision	10
Users with Limited Mobility	10
Setting Up the Poly TC10	12
Power the Poly TC10 with PoE	12
Power the Poly TC10 with a PoE Injector	12
Set up the Poly TC10 for the First Time in Paired Mode	12
Set up the Poly TC10 for the First Time as a Standalone Device	13
Configuring Network Settings	13
Manually Configure IPv6 Address Settings	13
Manually Assign a Host Name and Domain Name	14
Manually Configure DNS Settings	14
Configure Poly TC10 VLAN Settings	14
Manually Pair the Poly TC10 with a Video System	15
Using the Poly TC10 in Poly Video Mode	16
Cameras	16
Selecting the Primary Camera	16
Using Camera Presets	16
Environment Controls	17
Control Room Elements Using the Poly TC10	17
Poly TC10 LED Status Indicators as a Room Controller in Poly Video Mode	17
Using the Poly TC10 in Zoom Rooms Mode	19
Switch Between Controller and Scheduler Mode	19
Poly TC10 LED Status Indicators in Zoom Rooms Controller Mode	19
Poly TC10 LED Status Indicators in Zoom Rooms Scheduler Mode	19
Device Maintenance	21
Updating TC10 Software	21
Unpair the TC10 from a Video System	21
Restart the TC10	21
Factory Reset the Poly TC10	21
Factory Restore the Poly TC10 in the UI	22
Factory Restore the Poly TC10 in the Zoom Device Manager	22
Troubleshooting	23
View the Poly TC10 and Paired Video System Information	23
Downloading Poly TC10 Logs	23
Paired IP Devices	23
IP Device Can't Pair to the Video System	23
IP Device Doesn't Display on the Available Devices List	24
Paired IP Device is Disconnected	24
IP Device Paired to Inaccessible Video System	25

Zoom Rooms Pairing Error25

Before You Begin

This guide helps you understand how to set up, manage, and use your Poly TC10 device.

Audience, Purpose, and Required Skills

This guide is intended for beginning-to-intermediate users who participate in video-conferencing calls and technical users familiar with setting up and managing telecommunications systems and equipment.

Product Terminology Used in This Guide

Use the following information to help you understand how this guide sometimes refers to Poly products.

Device	Refers to the Poly TC10 device.
Video system	Refers to the Poly G7500 and the Poly Studio X-Series.
System	Another way of referring to the Poly G7500 and the Poly Studio X-Series.

Related Poly and Partner Resources

See the following sites for information related to this product.

- [Poly Support](#) is the entry point to online product, service, and solution support information. Find product-specific information such as Knowledge Base articles, Support Videos, Guide & Manuals, and Software Releases on the Products page, download software for desktop and mobile platforms from Downloads & Apps, and access additional services.
- The [Poly Documentation Library](#) provides support documentation for active products, services, and solutions. The documentation displays in responsive HTML5 format so that you can easily access and view installation, configuration, or administration content from any online device.
- The [Poly Community](#) provides access to the latest developer and support information. Create an account to access Poly support personnel and participate in developer and support forums. You can find the latest information on hardware, software, and partner solutions topics, share ideas, and solve problems with your colleagues.
- The [Poly Partner Network](#) is a program where resellers, distributors, solutions providers, and unified communications providers deliver high-value business solutions that meet critical customer needs, making it easy for you to communicate face-to-face using the applications and devices you use every day.
- [Poly Services](#) help your business succeed and get the most out of your investment through the benefits of collaboration. Enhance collaboration for your employees by accessing Poly service solutions, including Support Services, Managed Services, Professional Services, and Training Services.
- With [Poly+](#) you get exclusive premium features, insights and management tools necessary to keep employee devices up, running, and ready for action.
- [Poly Lens](#) enables better collaboration for every user in every workspace. It is designed to spotlight the health and efficiency of your spaces and devices by providing actionable insights and simplifying device management.

Getting Started

The Poly TC10 delivers room scheduling with Zoom Rooms or lets you control supported Poly video conferencing systems. Flexible deployment options provide a range of operating modes that meet different room requirements.

Poly TC10 Overview

You can pair the Poly TC10 with a Poly video system, for example a G7500 system, or use it as a standalone (unpaired) controller.

- In paired mode, the Poly TC10:
 - Pairs with a Poly video system.
 - Supports all Poly partner modes except Microsoft Teams.
- In standalone mode, the Poly TC10:
 - Operates alone; you don't need to pair it with a Poly video system.
 - Supports Zoom Rooms Mode only, running either Zoom Room Controller or Zoom Rooms Scheduler.

The Poly TC10 works with the following systems in paired mode:

- Poly G7500
- Poly Studio X70
- Poly Studio X50
- Poly Studio X30

Related Links

[Setting Up the Poly TC10](#) on page 12

Poly TC10 in Poly Video Mode as a Room Controller

With the Poly TC10, you can control and manage aspects of a Poly video system.

The Poly TC10 must be paired with a video system to operate in Poly Video Mode.

The following features and capabilities are available in Poly Video Mode:

- Placing and joining video calls
- Viewing and joining scheduled calendar meetings
- Managing contacts, call lists, and directories
- Managing shared content
 - Taking snapshots
 - Maximizing, minimizing, and stopping content
- Adjusting camera pan, tilt, zoom and tracking settings
- Creating camera presets
- Adjusting display brightness
- Using multiple Poly TC10 controllers to control a single system
- Pairing with video systems over the network (wired LAN) for flexible room setups

Related Links

[Using the Poly TC10 in Poly Video Mode](#) on page 16

Poly TC10 in Zoom Rooms Mode

Within Zoom Rooms, the Poly TC10 can run either as a Zoom Rooms Controller or a Zoom Rooms Scheduler.

- Zoom Rooms Controller: Positioned inside a conference room, use the Poly TC10 to start and manage meetings, share content, and more.
- Zoom Rooms Scheduler: Mounted outside a meeting room, the Poly TC10 displays the room status and upcoming scheduled meetings.

Note: To use Zoom Rooms Controller and Scheduler, you need a Zoom Rooms account. To use all of the functionality of the Zoom Rooms Scheduler, log in to the scheduler with a Zoom Rooms admin account.

Related Links

[Switch Between Controller and Scheduler Mode](#) on page 19

Zoom Rooms Mode as a Room Controller

Run Zoom Rooms Controller on the Poly TC10 in a meeting space to launch and manage Zoom meetings.

With Zoom Rooms Controller, you pair the Poly TC10 with a Zoom Room running on a Poly Studio X-Series, codec, or a desktop PC/Mac. The Zoom Room Controller controls the Zoom Room. You can start a scheduled or unscheduled meeting, invite participants to a meeting, view upcoming meetings, share content, dial out a phone call, and manage all aspects of a Zoom meeting.

Zoom Rooms Mode as a Room Scheduler

Run Zoom Rooms Scheduler on a Poly TC10 mounted outside a meeting room to manage the room. The Poly TC10 displays the current status of the room and any scheduled meetings.

Administrators can sync the following calendars to a Zoom Room:

- Google Calendar
- Office 365
- Microsoft Exchange

Once synced, the calendar meetings for that day appear on the display.

Users can perform the following tasks on a Poly TC10 running Zoom Rooms Scheduler:

- See the current status of the Zoom Room and any upcoming meetings
- Reserve a time slot in the Zoom Room calendar
- Reserve a time slot in another Zoom Room in an integrated floor plan
- Cancel a meeting that a user scheduled through the Zoom Rooms Scheduler

Poly TC10 Hardware Overview

The following illustration and table outline the hardware features of the TC10.

Figure 1: Poly TC10 hardware features

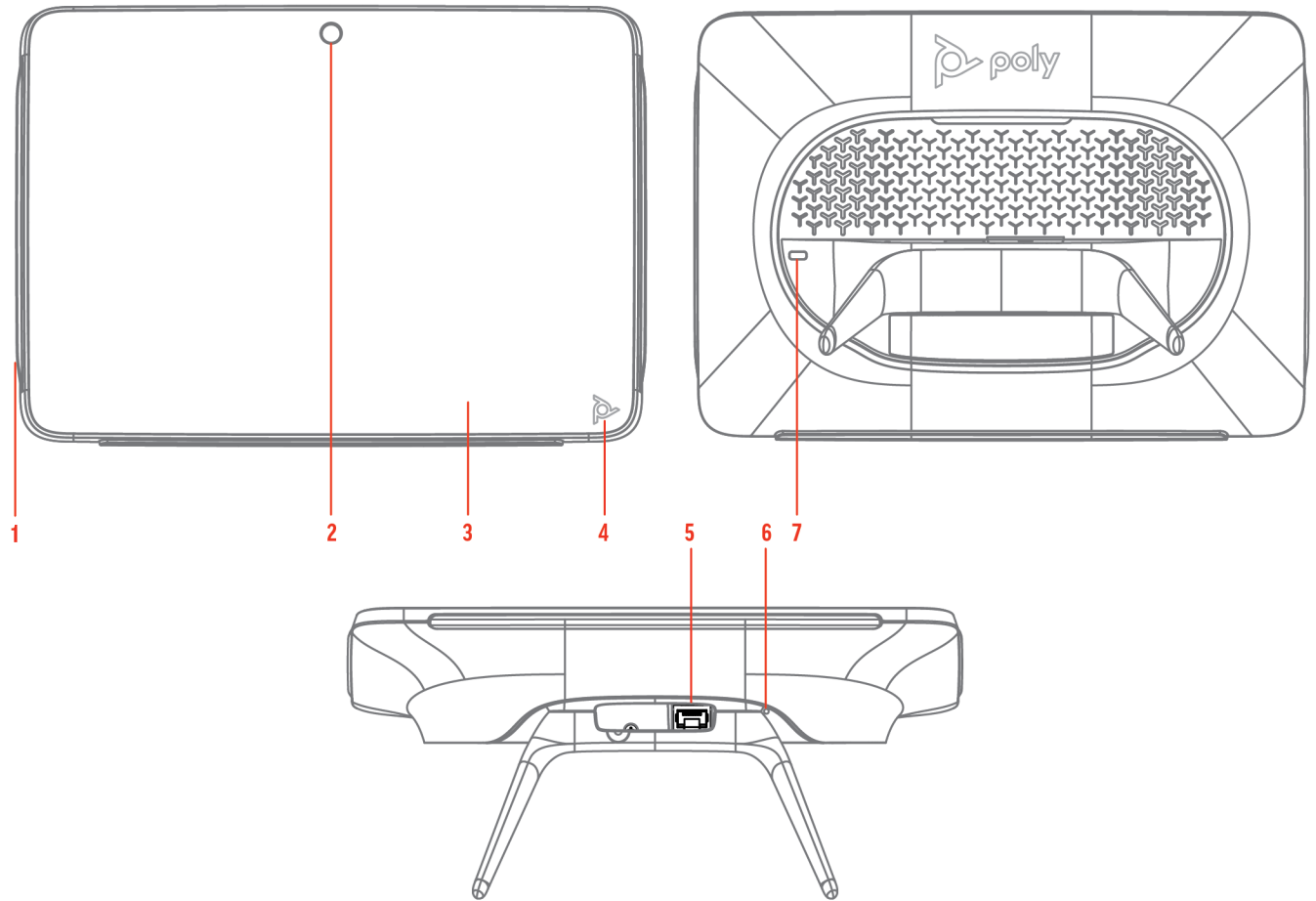

Poly TC10 Hardware Features

Ref. Number	Description
1	LED bar
2	Motion sensor to wake up display
3	Touchscreen
4	Poly touch button to launch Poly control dock menu
5	LAN connection port
6	Factory restore pinhole
7	Security lock

Poly TC10 Local Interface

The Poly TC10 controller's local interface displays controls and settings available to you depending on the mode you're using.

Poly TC10 Status Bars

The Poly TC10 controller provides two LED bars on the right and left edges of the screen.

These LEDs help you understand the controller's behaviors.

Related Links

[Poly TC10 LED Status Indicators in Zoom Rooms Controller Mode](#) on page 19

[Poly TC10 LED Status Indicators in Zoom Rooms Scheduler Mode](#) on page 19

[Poly TC10 LED Status Indicators as a Room Controller in Poly Video Mode](#) on page 17

Home Screen in Poly Video Mode

The Home screen is the first screen you encounter in Poly Video Mode. From this screen, you have quick access to many of the system functions.

Note: Some elements of your screen may be different depending on the system configuration.

Home Screen

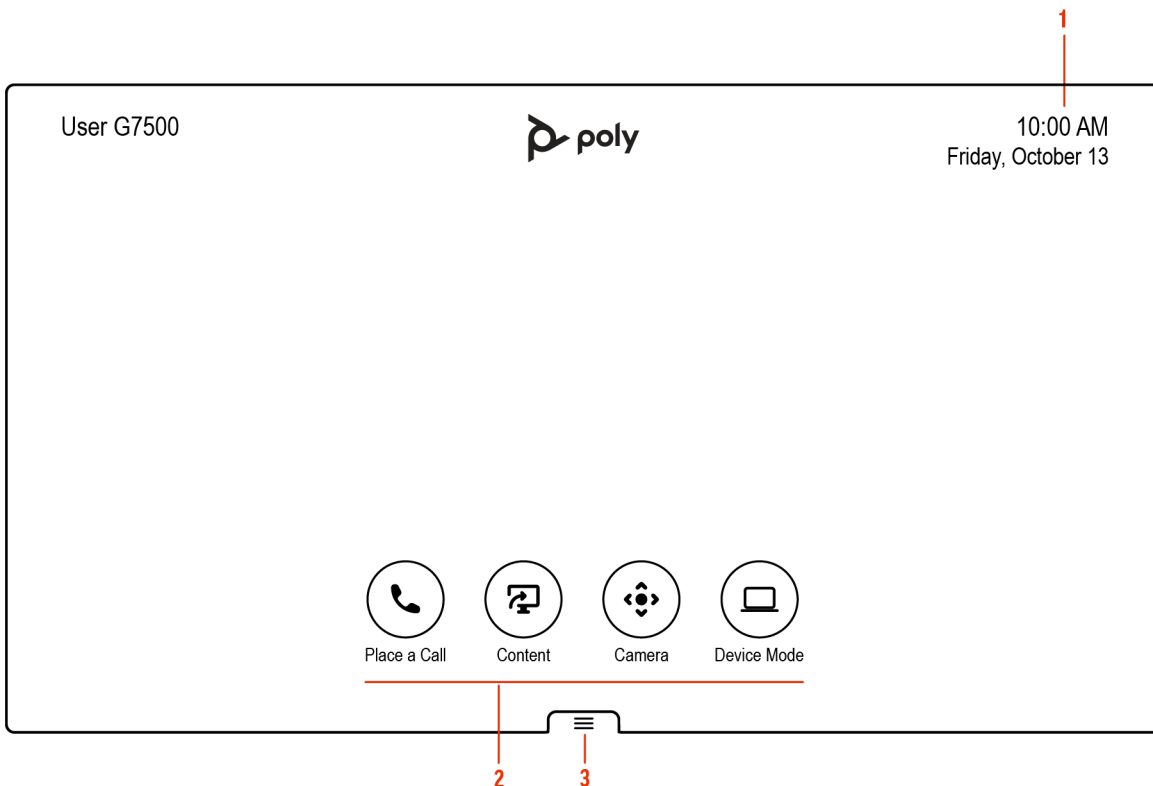





Ref. Number	Description
1	System information bar, which shows details such as date/time and system name.

Ref. Number	Description
2	Task buttons for placing calls, managing content, controlling cameras, or launching Poly Device Mode.
3	Menu for accessing other features.

Home Screen Elements

Some of the following interactive and read-only elements might not display on your system depending on the system configuration.

Element	Description
Name	Descriptive name determined by the system administrator. Used when you want to connect to a system.
IP address	IP address, SIP, H.323, or secondary network configured for your system.
Current time	Local time zone.
Current date	Local time zone date.
Calendar or Favorites cards	View your calendar or favorites.
Place a Call 	Opens a call screen where you can dial a call, or you can select a card to dial numbers, access favorites, or view your calendar.
Content 	When content is available, the system displays a list of available content. Otherwise, this function opens a help screen that describes how to set up content sharing using HDMI, the Polycom Content App, or an AirPlay- or a Miracast-certified device.
Camera 	Opens the camera control screen.
Poly Device Mode 	Launches Poly Device Mode, which allows you to use the Poly Video system as an external camera, microphone, and speaker for your connected laptop.
Menu 	Opens new menu selections for calling, sharing content, camera control, and additional functions.

Access the Poly Control Center

If your system is using a conferencing application that isn't Poly, you can still access the TC10 device and paired video system settings in the Poly Control Center.

Task

- » On the right side of the device touchscreen, swipe left or touch the Poly touch button on the bottom right of your touch screen.
The Poly Control Center opens.

Waking the Poly TC10

After a period of no activity, the system enters sleep mode (if configured by your administrator). When the motion sensor over the touchscreen detects movement, it wakes up the display.

Accessibility Features

Poly products include a number of features to accommodate users with disabilities.

Users Who Are Deaf or Hard of Hearing

Your system includes accessibility features so that users who are deaf or hard of hearing can use the system.

The following table lists the accessibility features for users who are deaf or hard of hearing.

Accessibility Features for Users Who Are Deaf or Hard of Hearing

Accessibility Feature	Description
Visual notifications	Status and icon indicators let you know when you have incoming, outgoing, active, or held calls. Indicators also alert you of the device's status and when features are enabled.
Status indicator lights	The system uses LEDs to indicate some statuses, including if your microphones are muted.
Adjustable call volume	While in a call, you can raise or lower the volume of the device.
Auto-answering	You can enable the system to auto-answer calls.

Users Who Are Blind, Have Low Vision, or Have Limited Vision

Your system includes accessibility features so that users who are blind, have low vision, or have limited vision can use the system.

The following table lists the accessibility features for users who are blind, have low vision, or have limited vision.

Accessibility Features for Users Who Are Blind, Have Low Vision, or Have Limited Vision

Accessibility Feature	Description
Auto-answering	You can enable the system to auto-answer calls.
Adjustable backlight settings	You can change the brightness of the screen by adjusting backlight intensity settings.
Visual notifications	Status and icon indicators let you know when you have incoming, outgoing, active, or held calls. Indicators also alert you of the device's status and when features are enabled.

Users with Limited Mobility

Your system includes accessibility features so that users with limited mobility can use various system features.

The following table lists the accessibility features for users with limited mobility.

Accessibility Features for Users with Limited Mobility

Accessibility Feature	Description
Alternative control interface	This product provides an alternative control interface for the connected video conferencing system for people with disabilities that cause limited manipulation issues.
Auto-answering	You can enable the system to auto-answer calls.
Calling from a personal device	With administrator credentials, you can wirelessly access the system web interface from your own device to make calls and manage contacts and favorites.
Flexible mounting/display configurations	Product isn't stationary and can be mounted or displayed in various configurations. Touch controls require minimal strength to operate.

Setting Up the Poly TC10

Pair the TC10 with a Poly video system over your primary network or set it up in standalone mode.

Important: You need to update a new Poly TC10 to the latest software to use all the features of the system. On initial powerup, the system displays a **Critical Update Required** message. Allow the device to go through the update process before configuring and deploying.

Related Links

[Poly TC10 Overview](#) on page 5

[Configuring Network Settings](#) on page 13

Power the Poly TC10 with PoE

Because the TC10 gets power through the LAN, the connection must support Power over Ethernet (PoE).

Task

- » Connect the TC10 to your network using the supplied LAN cable.

Power the Poly TC10 with a PoE Injector

If your space isn't equipped with Power over Ethernet (PoE), you can use a PoE injector to power the TC10.

Task

- 1 Plug the AC power cord of the PoE injector into an accessible earthed mains outlet.
- 2 Connect the PoE injector to the TC10 using a LAN cable.
- 3 Connect the PoE injector to your network with a LAN cable.

Set up the Poly TC10 for the First Time in Paired Mode

When paired with a Poly video system, you can use the Poly TC10 to control a video system. In paired mode, the Poly TC10 supports all Poly partner modes except Microsoft Teams.

Task

- 1 Power up the Poly TC10 with Power over Ethernet (PoE).
- 2 If a Poly TC10 software update is available, select **Update**.
The Poly TC10 updates and restarts.
- 3 Select a language and select **Continue**.
- 4 The device detects the LAN network. Select **Continue**.
- 5 Select **Pair with a video system**, then **Continue**.
- 6 Pair the Poly TC10 with the video system, as outlined in **Manually Pair the Poly TC10 with a Video System**.
- 7 Once paired, in the system web interface, go to **General Settings > Provider**.
- 8 Select a provider from the provider drop-down menu.
- 9 Select **Save**, then select **Restart**.
The system restarts and launches the selected provider.

Related Links

[Manually Pair the Poly TC10 with a Video System](#) on page 15

[IP Device Doesn't Display on the Available Devices List](#) on page 24

[Paired IP Device is Disconnected](#) on page 24

[IP Device Can't Pair to the Video System](#) on page 23

[Zoom Rooms Pairing Error](#) on page 25

[IP Device Paired to Inaccessible Video System](#) on page 25

Set up the Poly TC10 for the First Time as a Standalone Device

As a standalone device, you can use the TC10 as a Zoom Rooms controller or a Zoom Rooms scheduler.

Task

- 1 Power up the Poly TC10 with Power over Ethernet (PoE).
- 2 If a Poly TC10 software update is available, select **Update**.
The Poly TC10 updates and restarts.
- 3 Select a language and select **Continue**.
- 4 The device detects the LAN network. Select **Continue**.
- 5 Select **Use as a standalone device**, then **Continue**.
- 6 Select the system time format and time zone. Select **Continue**.
- 7 Select **Zoom Rooms**, then **Continue**.
The Zoom Room app installs and launches.
- 8 Select **Sign in**.
- 9 Sign in to the Poly TC10 with a Zoom account login or an activation code for your Zoom Room. A user with administrator access can generate this code in [Zoom Rooms Management](#).

Note: You can also pair your Poly TC10 to a Zoom Room account by signing in to your Zoom Room account in a web browser. Enter the pairing code displayed on the devices here: <https://zoom.us/pair>.

- 10 Select the Zoom Room that you want to control.

Note: The activation code is unique to each Zoom Room so this step isn't required if you sign in with an activation code.

- 11 Select **Room Controller** or **Scheduling Display** and select **Next**.

The Poly TC10 is paired and ready to control the Zoom Room app.

Configuring Network Settings

If your environment uses DHCP, after plugging it into a LAN port in the room with your video system, the Poly TC10 automatically connects to your primary network.

You can also manually configure the network settings if, for example, your environment needs static IP addresses or the DHCP server is offline.

Note: Network settings are available prior to pairing with a codec or in standalone mode.

Related Links

[Setting Up the Poly TC10](#) on page 12

Manually Configure IPv6 Address Settings

Your system gets its IP address information automatically by default. However, you can manually configure the IPv6 address settings.

Task

- 1 In the device local interface, go to **Settings**  **> Network**.
- 2 Turn the **Enable IPv6** setting on.
- 3 Turn the **Obtain Automatically Using DHCP** setting off.
- 4 Configure the following settings:

Setting	Description
Link-Local	Specifies the IPv6 address to use for local communication within the subnet.
Site-Local	Specifies the IPv6 address to use for communication within the site or organization.
Global Address	Specifies the IPv6 internet address.
Default Gateway	Specifies the default gateway assigned to your system.

5 Select **Save**.

Manually Assign a Host Name and Domain Name

You can manually enter the host name and domain name for your TC10 device. You also can modify these settings even if your network automatically assigns them.

Task

- 1 In the device local interface, go to **Settings**  > **Network**.
- 2 Enter or modify the device **Host Name**.
If the device discovers a valid name during setup or a software update, the device automatically creates the host name. However, if the device finds an invalid name, such as a name with a space, the device creates a host name using the following format: `DeviceType-xxxxxxx`, where `xxxxxxx` is a set of random alphanumeric characters.
- 3 Optional: Enter or modify the **Domain Name** that the device belongs to.
- 4 Select **Save**.

Manually Configure DNS Settings

You can manually specify the DNS server settings for your TC10 device.

Task

- 1 In the device local interface, go to **Settings**  > **Network**.
- 2 Turn the **Obtain Automatically Using DHCP** setting off.
- 3 Enter the DNS server addresses your device uses (you can enter up to four addresses).
- 4 Select **Save**.

Enable LLDP on Your Poly TC10

You can configure your Poly TC10 to automatically select VLAN settings using LLDP.

The VLAN ID of the TC10 must match the VLAN ID of the system for system pairing to be successful.

Note: VLAN isn't supported in IPv6 environments.

Task

- 1 In the device local interface, go to **Settings**  > **Network**.
- 2 Select the **LLDP** toggle button to turn the setting on.
The TC10 automatically assigns a value to **VLAN ID** based on your network configuration.
- 3 Select **Save**.

Configure Poly TC10 VLAN Settings

You can configure the TC10 virtual LAN (VLAN) settings.

The VLAN ID of the Poly TC10 must match the VLAN ID of the system for system pairing to be successful.

Note: VLAN isn't supported in IPv6 environments.

Task

- 1 In the device local interface, go to **Settings**  > **Network**.
- 2 Select the **802.1p/Q** check box and enter a **VLAN ID**.
The ID specifies the VLAN that you want the Poly TC10 to operate on. You can use values from 1 to 4094.
- 3 Select **Save**.

Manually Pair the Poly TC10 with a Video System

You can manually pair the Poly TC10 connected to your primary network with a video system in the room.

To pair, the Poly TC10 must be on the same subnet as the video system and the following network components unblocked:

- Multicast address 224.0.0.200
- UDP port 2000
- TCP port 18888

You may see multiple devices that you can pair with on your video system's Device Management page. Know the MAC address to ensure you're pairing with the device you want such as the device in the room you're setting up.

Task

- 1 Connect the Poly TC10 that you want to pair to an Ethernet port in the room.
- 2 In the system web interface, go to **General Settings > Device Management**.
- 3 Under **Available Devices**, find the device by its MAC address such as **00e0db4cf0be** and select **Pair**.
If paired successfully, the device displays under **Connected Devices** with a **Connected** status. If a device shows a **Disconnected** status, the pairing wasn't successful.

If pairing isn't successful, check the network connection and the configuration of both the Poly TC10 and the system you want to pair it with.

Related Links

[IP Device Can't Pair to the Video System](#) on page 23

[IP Device Doesn't Display on the Available Devices List](#) on page 24

[Paired IP Device is Disconnected](#) on page 24

[IP Device Paired to Inaccessible Video System](#) on page 25

[Set up the Poly TC10 for the First Time in Paired Mode](#) on page 12

[Zoom Rooms Pairing Error](#) on page 25

Using the Poly TC10 in Poly Video Mode

Pair the Poly TC10 with a video system and set the **Provider** to **Poly** in the system web interface to control and manage your Poly video system with the Poly TC10.

Note: Poly Video Mode isn't available if the Poly TC10 is in standalone mode.

Related Links

[Poly TC10 in Poly Video Mode as a Room Controller](#) on page 5

Cameras

Camera controls are available in and out of calls.

You can control cameras, depending upon the camera type, in the following ways:

- Adjust an in-room camera
- Turn camera tracking on or off

Selecting the Primary Camera

In Poly Video Mode and Zoom Rooms, if you have more than one camera attached to the system, you can select the primary camera in or out of a call.

Camera Priority

When you connect or disconnect a camera, camera priority determines the primary or active camera.

Note: The system doesn't support hot plugging cameras while in Device Mode. If the system is in Device Mode, exit Device Mode before attaching a camera to the system.

- When you attach a camera to a system that's powered on, it automatically becomes the current people camera.
- If you attach a camera during a call, it automatically becomes the current people camera.
- If you disconnect the current people camera, the system falls back to the next priority camera.

The system observes the following camera type priority:

- 1 Embedded camera
- 2 HDCI camera
- 3 USB camera
- 4 HDMI source set to display as people

Select the Primary Camera Using the Poly TC10

When you attach multiple cameras to the system, you can select the primary camera from the TC10 **Camera Controls** screen.

Task

- 1 Select **Camera** .
- 2 From the camera drop-down menu, select a camera.
The selected camera becomes the primary camera.

Using Camera Presets

If your camera supports presets, you can save up to 10 camera positions. Camera presets are stored camera positions that let you quickly point a camera at predefined locations in a room.

Near camera presets are available in or out of a call. Far camera presets are only available during a call. If enabled, you can use them to control the far-site camera.

When you save a preset, the preset saves the selected camera and the camera position.

Note: If camera tracking is on, camera controls and presets are unavailable. Turn tracking off to access these features.

Save a Camera Preset Using the Poly TC10

Save the current camera position as a preset for later use.

Use saved presets to change the near camera position in or out of a call. Far camera presets are available only in a call.

Task

- 1 Select **Camera** .
- 2 Adjust the camera to the desired position.
- 3 Under **Presets**, do one of the following:
 - On an empty preset card, press the preset card.
 - To replace a preset, long press the preset card for 1 second.

Select a Preset

Using previously created camera presets, you can quickly move the camera to a desired position in a call.



Task

- 1 Select **Camera** .
- 2 Select the image of the preset you want.

Delete a Preset

You can delete a camera preset that you no longer need.

Task

- 1 Select **Camera** .
- 2 Select **Delete** .

Environment Controls

Using the Poly TC10, you can control room elements that enable you to customize your meeting environment.

Control Room Elements Using the Poly TC10

You can control room elements such as electronic shades, smart lighting, monitors, and projectors using the Extron Room Control App on the Poly TC10.

The administrator must enable the **Environment** menu option and configure the room elements using an Extron processor.

Task

- 1 Select **Environment** .
- 2 Choose one of the following:
 - **Lights** - Adjust the lights in the room.
 - **Shades** - Adjust the electronic shades in the room.
 - **Display** - Control monitors and projectors in the room.

Poly TC10 LED Status Indicators as a Room Controller in Poly Video Mode

The following table lists each LED indicator and its related status while the Poly TC10 is operating in Poly Video Mode as a room controller.

Poly TC10 Status Indicators as a Room Controller in Poly Video Mode

Status	LED Color	Animation Behavior
Boot initialization in progress	White	Breathing
Idle (not in a call)	White	Solid
Sleep	Amber	Solid
Incoming call	Green	Fluttering
Outgoing call	Green	Solid
Call in progress	Green	Solid
Muted microphone/Audio mute	Red	Solid
Firmware update in progress	Amber	Breathing

Related Links

[Poly TC10 Status Bars](#) on page 8

Using the Poly TC10 in Zoom Rooms Mode

You can use the Poly TC10 in Zoom Rooms Mode when it's paired to a video system or in standalone mode.

When you launch Zoom Rooms, you can choose to run Zoom Rooms Controller or Zoom Rooms Scheduler.

Switch Between Controller and Scheduler Mode

You can switch between Zoom Rooms Controller and Zoom Rooms Scheduler in the settings.

Task

- 1 On the Poly TC10, choose **Settings**.
- 2 Select **General**.
- 3 Scroll down and select **Switch to Controller** or **Switch to Scheduler**.

Note: The option available depends on what mode that you're currently running.

Related Links

[Poly TC10 in Zoom Rooms Mode](#) on page 5

Poly TC10 LED Status Indicators in Zoom Rooms Controller Mode

The following table lists each LED indicator and its associated status while the Poly TC10 is operating in Zoom Rooms as a meeting controller.

TC10 LED Status Indicators as a Meeting Controller in Zoom Rooms

Status	LED Color	Animation Behavior
Boot up in progress	White	Breathing
Idle (not in a call)	White	Solid
Outgoing call	Green	Solid
Call in progress	Green	Solid
Muted microphone / Audio mute	Red	Solid
Firmware update in progress	Amber	Breathing

Related Links

[Poly TC10 Status Bars](#) on page 8

Poly TC10 LED Status Indicators in Zoom Rooms Scheduler Mode

The following table lists each LED indicator and its associated status while the device is in Zoom Rooms Scheduler Mode.

TC10 LED Status Indicators in Zoom Rooms Scheduler Mode

Status	LED Color	Animation Behavior
Boot up in progress	White	Breathing
Room available	Green	Solid
Room occupied - meeting in progress	Red	Solid

Status	LED Color	Animation Behavior
--------	-----------	--------------------

Firmware update in progress	Amber	Breathing
-----------------------------	-------	-----------

Related Links

[Poly TC10 Status Bars](#) on page 8

Device Maintenance

You have several options to keep your device running properly.

Updating TC10 Software

You can update your system software in different ways depending on how the device is set up, and the mode it's running.

Updating a Paired Poly TC10

The TC10 software updates when you update the paired video system.

To manually update the software via the codec, in the system web interface, go to **General Settings > Device Management**. Select **Check for Updates**. If the system finds updates, select **Update All**.

You can also update the device via the Zoom Device Management (ZDM). The ZDM offers remote functionality on Zoom Room devices. Access ZDM from the Zoom web portal. Go to **Device Management > Update Management**.

For more information, see your video system's *Administrator Guide* at the [Poly Documentation Library](#).

Updating a Standalone Poly TC10

You can update a standalone Poly TC10 device running Zoom Rooms in the settings screen by going to **Zoom > System settings > Update software section**.

You can also update a standalone device running Zoom Rooms in the Zoom Rooms web portal. Go to **Device Management > Update Management**.

Unpair the TC10 from a Video System

Unpair the TC10 if you no longer want to use it with a particular video system.

Don't unpair devices if you plan to use them with the same system. For example, if you move your video-conferencing equipment to another room, just disconnect and reconnect the devices in the new location.

Task

- 1 In the system web interface, go to **General Settings > Device Management**.
- 2 Under **Connected Devices**, find the device by its MAC address (for example, **00e0db4cf0be**) and select **Unpair**. The unpaired device moves from **Connected Devices** to **Available Devices** (which shows discovered devices you can pair with the system).

Restart the TC10

If you have issues, you can try restarting the Poly TC10.

Task

- 1 For a wall- or glass-mounted device, dismount it and remove any wall mounting brackets. For a desk-mounted device, remove the TC10 stand. For more information, see the relevant Quick Start Guide.
- 2 Disconnect the LAN cable from the Poly TC10 and reconnect it.

Factory Reset the Poly TC10

You can reset the TC10 to its default settings. This process refreshes the device by deleting its configurations except the current version of software.

Task

- 1 For wall- or glass-mounted devices, dismount it, and remove any wall mounting brackets. For a desk-mounted device, remove the TC10 stand. For more information, see the relevant Quick Start Guide.
- 2 Disconnect the LAN cable from the Poly TC10 to power it off.
- 3 On the back of the Poly TC10, insert a pin or straightened paper clip through the factory reset button pinhole.

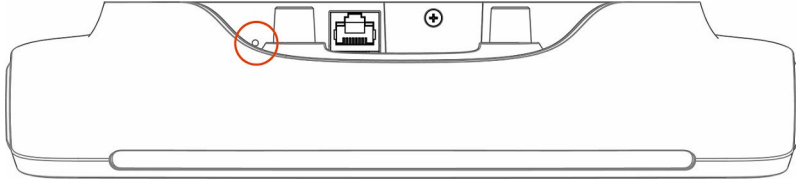

- 4 Press and hold the reset button, and reconnect the LAN cable to power the Poly TC10 on.
Don't power off the Poly TC10 until it finishes the factory reset process.

Factory Restore the Poly TC10 in the UI

You can restore the TC10 to its default settings in the device UI. This process refreshes the device by deleting its configurations except the current version of software.

If paired to a codec, unpair the device before factory restore.

Task

- 1 In the device local interface, go to **Settings**  > **Reset** > **Reset**.
- 2 To confirm, select **Reset**.
The Poly TC10 resets all configurations to factory defaults. The most recently installed version of software remains on the device.

Factory Restore the Poly TC10 in the Zoom Device Manager

You can restore the TC10 to its default settings in the Zoom Device Manager (ZDM). This process refreshes the device by deleting its configurations except the current version of software.

Connect the Poly TC10 to a Zoom Rooms account.

Task

- 1 Open ZDM from the Zoom web portal.
- 2 Go to **Device Management** > **Device List**.
- 3 Click the **Devices** list.
- 4 Click on the name of the device that you want to reset.
- 5 In the **Details** tab, select **Factory Reset**.

Troubleshooting

These troubleshooting tips can help when encountering issues with your TC10 device.

View the Poly TC10 and Paired Video System Information

You can see basic information about your TC10 and the paired video system in the device local interface.

Some of the Poly TC10 and video system details include:

- Device name
- Name of paired-video system
- Model
- MAC address
- IP address
- Hardware version
- Software version
- Serial number

Task

» In the device local interface, go to **Settings**  **> Information**.

Downloading Poly TC10 Logs

Download Logs When Paired to Video System

The Poly TC10 logs are available in the paired video system's log package. To download the log package, see your video system's [Administrator Guide](#).

Download Logs from Zoom Device Management (ZDM)

You can also download logs from the Zoom Device Management (ZDM), a device management tool, which offers remote functionality on Zoom Room devices. Access ZDM from the Zoom web portal.

Paired IP Devices

Use the following information to troubleshoot issues with paired IP devices.

IP Device Can't Pair to the Video System

Symptom:

You may notice one or both of the following:

- After powering on the TC10 device, it doesn't automatically pair with the video system.
- You can't manually pair the device from the **Available Devices** list in the video system web interface.

Problem:

There are a few possible causes for this issue:

- Network traffic on TCP port 18888 is blocked.
- Your system and TC10 aren't on the same VLAN.

Workaround:

Complete each step until the device pairs with your system:

Task

- 1 Allow traffic on TCP port 18888.

2 On your TC10 device, verify that the TC10 VLAN ID matches the VLAN ID on your system.

Related Links

[Manually Pair the Poly TC10 with a Video System](#) on page 15

[Set up the Poly TC10 for the First Time in Paired Mode](#) on page 12

IP Device Doesn't Display on the Available Devices List

Symptom:

The TC10 device you want to pair is connected to the network but you don't see it under **Available Devices** in the video system web interface.

Problem:

There are a few possible causes for this issue:

- The device and video system aren't on the same subnet.
- The network switch isn't allowing UDP broadcast traffic forwarded to multicast address 224.0.0.200 on port 2000.
- The device is paired with another video system.

Workaround:

Complete each step until you see the TC10 device on the **Available Devices** list:

Task

- 1 Make sure the device and video system are on the same subnet.
If needed, work with your network administrator.
- 2 Allow traffic to 224.0.0.200 on UDP port 2000.
- 3 Make sure the device isn't paired with another video system. If it is, unpair the device.
- 4 Go to **Settings > Reset** and select **Reset**.
Your device resets to its default configuration settings, which unpairs it from the video system.

Related Links

[Manually Pair the Poly TC10 with a Video System](#) on page 15

[Set up the Poly TC10 for the First Time in Paired Mode](#) on page 12

Paired IP Device is Disconnected

Symptom:

You paired a TC10 device with your video system but can't use it. On the system web interface **Device Management** page, you see that the device is **Disconnected**.

Problem:

A paired device must have a **Connected** status to use. A **Disconnected** status may mean there's a physical connection issue or your device or system is malfunctioning.

Workaround:

Complete each step until you fix the issue.

Task

- 1 Check the device's LAN cable connection.
- 2 Restart the device.
- 3 Restart the video system.
- 4 Make sure network traffic on TCP port 18888 is unblocked.
- 5 Perform a factory restore on the device.
- 6 Perform a factory restore on the system.

Related Links

[Manually Pair the Poly TC10 with a Video System](#) on page 15

[Set up the Poly TC10 for the First Time in Paired Mode](#) on page 12

IP Device Paired to Inaccessible Video System

Symptom:

Your TC10 device was paired with a video system you can no longer access (for example, the video system lost its network connection or was moved to another location). Whatever the situation, the TC10 device screen now indicates it's waiting to pair.

Problem:

The TC10 device is still paired to the video system but can't connect to it.

Workaround:

When this happens, there's a reset button in the device **Settings** menu to unpair the device from the video system.

If you can eventually access the video system it was paired with, you also should unpair the device from the **Device Management** page. Otherwise, the device continues to display in the **Connected Devices** list but is Unavailable.

Once unpaired, you can pair the device with the same video system or another video system.

Task

- 1 Go to **Settings > Reset** and select **Reset**.
Your device resets to its default configuration settings, which unpairs it from the video system.
- 2 In the system web interface, go to **General Settings > Device Management**.
- 3 Under **Connected Devices**, find the device by its MAC address (for example, **00e0db4cf0be**) and select **Unpair**.
The device you're unpairing should have an Unavailable status.

Related Links

[Manually Pair the Poly TC10 with a Video System](#) on page 15

[Set up the Poly TC10 for the First Time in Paired Mode](#) on page 12

Zoom Rooms Pairing Error

Symptom:

You get an error message when pairing a Poly TC10 to a Zoom Room that is already logged into a room.

Workaround:

Ignore the code and pair the device to the Zoom Room using the authorization code or enter the pairing code at zoom.us/pair

Related Links

[Manually Pair the Poly TC10 with a Video System](#) on page 15

[Set up the Poly TC10 for the First Time in Paired Mode](#) on page 12