

DAM614

DIGITAL PROCESSORS & MATRIXES

Digital loudspeaker manager



USER MANUAL

INDEX

1. IMPORTANT REMARK	4
2. IMPORTANT SAFETY INSTRUCTIONS.....	4
3. IMPORTANT NOTE.....	6
4. INTRODUCTION.....	6
4.1. <i>Main features.....</i>	6
5. INSTALLATION	8
5.1. <i>Location, set up and ventilation.....</i>	8
5.2. <i>AC connection and powering on.....</i>	8
6. PANEL FRONTAL.....	9
6.1. <i>INPUT 1 minijack connector.....</i>	9
6.2. <i>INPUT encoders and indicators.....</i>	9
6.3. <i>OUTPUT encoders and indicators.....</i>	10
6.4. <i>LCD display.....</i>	11
6.5. <i>Setup keys.....</i>	11
6.6. <i>SP/CLIP indicator light.....</i>	12
7. REAR PANEL.....	13
7.1. <i>Start-up.....</i>	13
7.2. <i>Input and output connectors.....</i>	13
7.3. <i>PAGER connector.....</i>	14
7.4. <i>REMOTE connectors.....</i>	14
7.5. <i>MUTE connector.....</i>	14
7.6. <i>RS-232 port.....</i>	15
8. MAIN SCREEN/MIXER MODE/PRESET MANAGEMENT.....	15
8.1. <i>MAIN SCREEN.....</i>	15
8.1.1. <i>Inputs:.....</i>	16
8.1.2. <i>Outputs:.....</i>	17

8.2. MIXER MODE	17
8.3. RECALL PRESET MENU	18
8.4. SAVE PRESET MENU	19
9. INPUT EDIT MENU.....	21
10. OUTPUT EDIT MENU	26
11. SETUP MENU	28
12. FRONT PANEL LOCK.....	33
13. CLEANING.....	34
14. DIAGRAMS	35
14.1. FUNCTIONS LIST	35
14.2. FUNCTION DIAGRAM	36
15. TECHNICAL CHARACTERISTICS	37
16. CONFIGURATION DIAGRAM	39
17. BLOCK DIAGRAM	40
18. CA-NET RS-232 Remote Control Protocol.....	41

1. IMPORTANT REMARK



WARNING: SHOCK HAZARD - DO NOT OPEN
AVIS: RISQUE DE CHOC ÉLECTRIQUE - NE PAS OUVRIR



The lightning flash with arrowhead symbol, within an equilateral triangle, is intended to alert the user to the presence of uninsulated “dangerous voltage” within the product’s enclosure that may be of sufficient magnitude to constitute a risk of electric shock to persons.



The exclamation point within an equilateral triangle is intended to alert the user to the presence of important operating and maintenance (servicing) instructions in the literature accompanying the appliance.

WARNING (If applicable): The terminals marked with symbol of “” may be of sufficient magnitude to constitute a risk of electric shock. The external wiring connected to the terminals requires installation by an instructed person or the use of ready-made leads or cords.

WARNING: To prevent fire or shock hazard, do not expose this equipment to rain or moisture.

WARNING: An apparatus with Class I construction shall be connected to a mains socket-outlet with a protective earthing connection.

2. IMPORTANT SAFETY INSTRUCTIONS

1. Read these instructions.
2. Keep these instructions.
3. Heed all warnings.
4. Follow all instructions.
5. Do not use this apparatus near water.
6. Clean only with dry cloth.
7. Do not block any ventilation openings. Install in accordance with the manufacturer’s instructions.

8. Do not install near any heat sources such as radiators, heat registers, stoves, or other apparatus (including amplifiers) that produce heat.
9. Do not defeat the safety purpose of the polarized or grounding type plug. A polarized plug has two blades with one wider than the other. A grounding type plug has two blades and a third grounding prong. The wide blade or the third prong are provided for your safety. If the provided plug does not fit into your outlet, consult an electrician for replacement of the obsolete outlet.
10. Protect the power cord from being walked on or pinched particularly at the plugs, convenience receptacles, and at the point where they exit from the apparatus.
11. Only use attachments/accessories specified by the manufacturer.
12. Unplug the apparatus during lightning sorts or when unused for long periods of time.
13. Refer all servicing to qualified personnel. Servicing is required when the apparatus has been damaged in any way, such as power supply cord or plug is damaged, liquid has been spilled or objects have fallen into the apparatus, the apparatus has been exposed to rain or moisture, does not operate normally, or has been dropped.
14. Disconnecting from mains: Switching off the POWER switch all the functions and light indicators of the amplifier will be stopped, but fully disconnecting the device from mains is done unplugging the power cord from the mains input socket. For this reason, it always shall remain readily operable.
15. Equipment is connected to a socket-outlet with earthing connection by means of a power cord.
16. The marking information is located at the bottom of apparatus.
17. The apparatus shall not be exposed to dripping or splashing and that no objects filled with liquids, such as vases, shall be placed on apparatus.

NOTE: *This equipment has been tested and found to comply with the limits for a Class A digital device, pursuant to part 15 of the FCC Rules. These limits are designed to provide reasonable protection against harmful interference when the equipment is operated in a commercial environment. This equipment generates, uses, and can radiate radio frequency energy and, if not installed and used in accordance with the instruction manual, may cause harmful interference to radio communications. Operation of this equipment in a residential area is likely to cause harmful interference in which case the user will be required to correct the interference at his own expense.*



WARNING: This product must not be discarded, under any circumstance, as unsorted urban waste. Take to the nearest electrical and electronic waste treatment centre.

NEEC AUDIO BARCELONA, S.L. accepts no liability for any damage that may be caused to people, animal or objects due to failure to comply with the warnings above.

3. IMPORTANT NOTE

Thank you for choosing our Ecler **DAM614 Digital Loudspeaker Manager!**

It is **VERY IMPORTANT** to carefully read this manual and to fully understand its contents before any connection in order to maximize your use and get the best performance from this equipment.

To ensure optimal operation of this device, we strongly recommend that its maintenance be carried out by our authorised Technical Services.

All ECLER products are covered by warranty, please refer to www.ecler.com or the warranty card included with this product for the period of validity and conditions.

4. INTRODUCTION

The DAM614 is a digital audio mixer featuring 6 audio inputs and 4 outputs, DSP processing, RS-232 connectivity and four remote control ports (0-10VDC).

4.1. Main features

- 2 stereo line inputs, with RCA connectors
- 4 balanced dual inputs (microphone/line), with Euroblock connectors, configurable as independent inputs (mono) or per pair as a third and fourth stereo input
- 4 balanced audio outputs, with Euroblock connectors: each output is configurable as a separate zone output (mono) or as a linked output for a stereo zone (A&B/C&D)
- DSP with 24-bit quantization and 48kHz sampling frequency
- 2x20 characters LCD Display on the front panel
- 4 setup keys on the front panel to navigate in the menus and set the parameters
- 6 digital controls (encoders) on the front panel, for input management (one per input)
- 4 digital controls (encoders) on the front panel, for output management (one per output)
- 10 LED indicators on the front panel (one per input and output)
- 4 REMOTE ports (0-10VDC) to control the volume of inputs or outputs, select sources, recall presets etc. from external devices, such as Wpa series panels
- PAGER port to connect the MPAGE4 4-zone paging station
- MUTE port for the muting of one or several output zones via external contact closure
- RS-232 interface and compatibility with EclerCOMM software (free download from www.ecler.com/en/products/audio/software and [CA-NET protocol for external remote control](#))

- Processing:
 - Independent level controls for each input and output
 - Independent mixing of a combination of inputs (crossing point activation and level) for each output zone (up to 4 independent mixes of the 6 audio inputs)
 - Independent 3-band tone adjustment (BASS-MID-TREBLE) for each input
 - Independent crossover filters for each output
 - Independent 10-band graphic equalizer for each output
 - High-Pass filter with adjustable frequency for the MIC/LINE inputs (inputs 3, 4, 5 and 6)
 - Independently configurable PAGER/DUCKER function for the inputs 3, 4, 5 and 6, with 2 priority levels (voice messages or pre-recorded messages with priority, paging from a paging station, etc.)
 - Noise gate, independently configurable for inputs 3, 4, 5 and 6
 - Audio feedback (Larsen effect) suppressor, independently configurable for inputs 3, 4, 5 and 6
 - Independent delay setting for each output
 - Independent compressor/limiter for each output
- System templates for the creation of user setups:
 - T1: 4 stereo inputs x 4 mono outputs
 - T2: 4 stereo inputs x 2 stereo outputs
 - T3: 4 stereo inputs x 1 stereo output + 2 mono outputs
 - T4: 3 stereo inputs + 2 mono inputs x 4 mono outputs
 - T5: 3 stereo inputs + 2 mono inputs x 2 stereo outputs
 - T6: 3 stereo inputs + 2 mono inputs x 1 stereo output + 2 mono outputs
 - T7: 2 stereo inputs + 4 mono inputs x 4 mono outputs
 - T8: 2 stereo inputs + 4 mono inputs x 2 stereo outputs
 - T9: 2 stereo inputs + 4 mono inputs x 1 stereo output + 2 mono outputs

Each system template automatically sets the operating and control mode of the channels and their settings, including the stereo linked group they pertain to. Example: in a stereo input or output configuration, the settings applied to the left channel are also automatically applied to the right channel, and vice versa

- User presets: 20
- Editing names (labels) of inputs, outputs and user presets
- Three front panel locking modes, with password protection: total, with the exception of MUTE/VOL for inputs and outputs, or with the exception of MUTE/VOL of outputs and activation and input levels

5. INSTALLATION

5.1. Location, set up and ventilation

Ecler DAM614 has been specially designed to be used both as a desktop mixer and a 19" rackmount unit.

The DAM614 does not require ventilation due to its low power consumption, however, it is recommended that the unit not be completely enclosed or exposed to extreme temperatures. Fresh air should be allowed to pass through the ventilation holes in the chassis, leaving at least one free rack unit between each device and those installed above and below it in the rack.

If multiple products are installed in the same rack or in a cabinet with closed doors, it is highly recommended to install fans in their upper and lower ends for a forced airflow from the bottom up. This upward air flow will help to dissipate heat generated inside.

5.2. AC connection and powering on

Ecler DAM614 is powered by alternating current through its external power supply: 100-240 VAC and 50-60 Hz. This external PSU has interchangeable connectors: American, European, British and Chinese.

On the rear panel, the power on/off switch is next to the external power supply connector.

To avoid buzzing, do not allow the external power supply cable to intertwine with and run parallel to the audio shielded cables.

6. PANEL FRONTAL

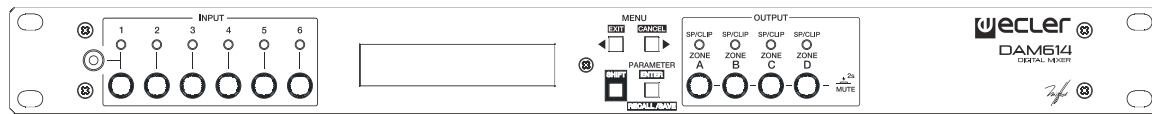

6.1. INPUT 1 minijack connector

Stereo INPUT 1 has a duplicate input connector, for the convenience of use: dual RCA on the back panel and stereo minijack on the front panel.

6.2. INPUT encoders and indicators

The INPUT 1 to INPUT6 knobs are digital encoders to be pressed or turned to offer various functions. Pressing them allows you to enable/disable each input for the output zone currently displayed on the LCD (ZA, ZB, ZC or ZD). The active inputs (LED on) are mixed and sent to the destination zones, after a DSP processing adjusted in the unit (volumes, tone adjustment, PAGER/DUCKER type priorities, etc.).

To enable or disable inputs for a given zone:

1. Briefly press one of the four ZONE A, B, C or D digital controls, in the OUTPUT section of the front panel
2. The LCD will display the selected zone in its upper left corner (ZA, ZB, ZC or ZD)
3. The INPUT 1 to 6 LEDs will show the inputs that are enabled for this zone (lit = enabled input)
4. Briefly press any of the INPUT encoders to enable/disable the corresponding input for this zone

Note: the INPUT 3 to 6 encoders are linked if you select the stereo mode for inputs 3&4 and/or 5&6: their LED indicators simultaneously light up and off when pressing one of them, indicating that this is a stereo pair (L-R) in which both will receive the same processing for level, EQ, etc.

Rotating one of these controls in this output display screen adjusts the mix level of the corresponding input in the targeted output, in order to configure a custom mix of inputs for each output. See section [MIXER mode](#) for more information.

The INPUT 1 to INPUT 6 encoders, in combination with the SHIFT key (press and hold encoder + IN key) also provide access to the input setup menu (see chapter [INPUT EDIT MENU](#)).

6.3. OUTPUT encoders and indicators

These four controls, one for each of the outputs (ZONE A, B, C or D), allow you to:

- Short press: select an output zone to be displayed on the LCD. Successive presses of the same output control alternate the display between two options:
 - Output volume: zone indication, ZA, ZB, ZC, ZD + horizontal bar graph indicating the output volume. In this screen, turning the encoder adjusts the output volume of the displayed zone.
 - MIXER Mode: displays the mix levels of all the inputs for the displayed zone. In this screen, turning the input encoders allows to adjust the mix level of each input for the displayed zone.
- Long press (> 2 seconds): enable/disable the MUTE feature of an output. The output LED indicator shows the status of its MUTE function (lit red = MUTE ON). You can press multiple keys simultaneously to enable/disable their MUTE function

Additionally, when an input, output or global parameters editing/setup screen is displayed, any of the four output encoders allow you to modify the value of the parameters currently displayed on the LCD, increasing or decreasing the value depending on the direction of rotation.

NOTES:

- The A&B and/or C&D keys are linked if you select the stereo mode for any pair of outputs: they simultaneously light up and off when enabling/disabling their MUTE mode or setting the VOLUME, indicating that this is a stereo pair in which both will receive the same processing for level, EQ, etc.
- The DAM614 automatically manages the routing of mono or stereo inputs to mono or stereo outputs:
 - A mono input is directly sent to a mono output, with its corresponding adjustment of send or mixing level, which is independent of the levels for the other inputs or outputs
 - A mono input is duplicated to be sent to the left and right channels of a stereo output, with its corresponding adjustment of send or mixing level, which is independent of the levels for the other inputs or outputs
 - A stereo input is sent to a mono output as a mono sum of its left and right channels (stereo-to-mono conversion), with its corresponding adjustment of send or mixing level, which is independent of the levels for the other inputs or outputs

- A stereo input is sent to a stereo output, respecting the stereo image between the two: the left channel of the input will be sent to the left channel (odd) of the output, while the right channel of the input will be sent to the right channel (even) of the output, with its corresponding adjustment of send or mixing level, which is independent of the levels for the other inputs or outputs

6.4. LCD display

Display showing digital and text data for inputs, outputs and setup menus, device settings and information.

6.5. Setup keys

The four front panel setup keys allow you to navigate through the various menus and their pages, and access special features thanks to certain combinations of keys pressed simultaneously:

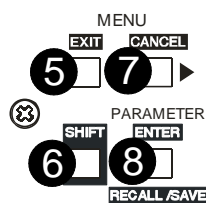

The left and right MENU keys (5, 7) allow scrolling through the different pages of the unit's setup menus.

The PARAMETER key allows, within a menu and a page, to select the parameter whose value has to be modified with an encoder: the name of the targeted parameter flashes in the display while its value can be edited.

The special combinations of the setup keys are:

- Left and right MENU simultaneously for 2 seconds: access to the unit's setup menu (see chapter [SETUP MENU](#)) as well as the front panel locking/unlocking and password management (see chapter [FRONT PANEL LOCK](#))
- SHIFT + left MENU (EXIT): return to the main screen, from any menu
- SHIFT + right MENU (CANCEL): undo the last parameter editing and recall the value as before the change
 - SHIFT + PARAMETER, short press (tap):
 - RECALL: load one of the presets (device setups) stored in the memory This function is not available when browsing some general setup menus of the unit
- ENTER: confirm an important modification (e.g.: password change) in some menus
- SHIFT + PARAMETER, long press:
- SAVE: save a preset containing the current device setup
- Right CANCEL, kept pressed while powering up the unit: load preset #1, designed to be edited and saved to be used as booting setup. This operation is allowed even when the unit's front panel is locked with a password
- ZA hold down and maintained while powering up the unit: displays the "*Power OFF to recover factory defaults*" message. After turning off and on again, default parameters (*factory defaults*) are restored, erasing all the user data, settings and presets in the unit's memory

6.6. SP/CLIP indicator light

The front panel LEDs indicates two types of information:

- Green light or SIGNAL PRESENT (SP): warn of the presence of signal at the mixer inputs. These indicators illuminate when the input signal exceeds -40dBV.
- Orange light or CLIP: light up when the signal level is close to actual clipping, +12 dBV. You must take care that these indicators do not remain continuously lit with the musical program you use.

7. REAR PANEL

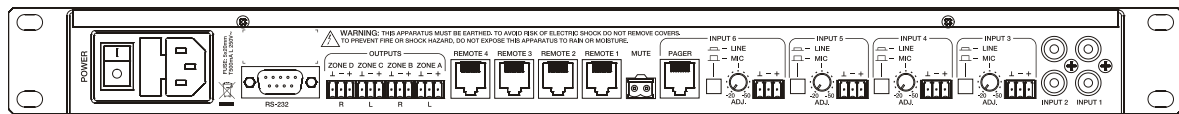

The back panel features the following connections:

7.1. Start-up

The external power supply connector and a tab for secure attachment of the source cable are located next to the unit's power switch.

7.2. Input and output connectors

The DAM614 has the following audio input connections:

- INPUT1 to INPUT2: unbalanced stereo connection, with 1/8" jack on the front panel (only INPUT1) and dual RCA on the rear panel. They're designed for -6 dBV and 0 dBV nominal signals, an internal jumper allowing adjusting the sensitivity (see section [FUNCTION DIAGRAM](#)). They can receive signals from CD players, radio tuners, mixing consoles, media players, audio outputs of computers and tablets, etc.
- INPUT 3, 4, 5 & 6 (**MIC/LINE**): dual (MIC/LINE) balanced Euroblock type connections on back panel, designed for a signal level between -30 dBV and 0 dBV (LINE level), or between -20 dBV and -50 dBV (MIC level), with an ADJ control to adjust the sensitivity. They can operate independently (mono) or be linked as a fourth stereo input for the unit, depending on the operating template or preset selected from the unit's preset recall menu, EclerCOMM Manager application software, a wall panel remote control, etc.

Note: turntables CAN'T BE DIRECTLY CONNECTED to this unit because none of the inputs has a RIAA preamplifier.

The DAM614 signal output is performed through four balanced 3-pin Euroblock connectors (ZONE A, B, C and D).

7.3. PAGER connector

Allows the connection of an MPAGE4 console (optional) to send voice messages with zone selection in real time (paging).

The connected console will use the INPUT6 channel, in LINE mode, for the management of the PAGER function (see the MPAGE4 console manual for more details).

You need to correctly setup the PAGER mode for Input 6 to enable this feature, from the device setup menu (front keys and LCD display) or from EclerCOMM Manager Application software (see chapter [INPUT EDIT MENU](#) for more information).

7.4. REMOTE connectors

The REMOTE connectors 1 to 4 allow you to control, from a Wpa series wall panel or similar (0-10VDC), the volume of one or several inputs, or the volume of one or several outputs simultaneously, to select presets, sources for one or several zones and control the volume sent to these zones etc. The inputs or outputs controlled by each REMOTE port are selected using either the device setup menu (front keys and LCD display) or EclerCOMM Manager Application software (see chapter [SETUP MENU](#) for more information).

The Wpa series wall panels must be configured with their internal jumpers in **10V / LIN** position.

7.5. MUTE connector

The rear panel **MUTE** connector allows the connection of an external potential free contact closure to mute one or several output zones of the device, when an external unit is activating it (example: a central alarm system for emergencies and evacuation). The MUTE port affects the outputs selected from the device setup menu (front keys and LCD display) or from EclerCOMM Manager application software (see chapter [SETUP MENU](#) for more information).

7.6. RS-232 port

The **RS-232** serial communication port allows remote management of DAM614 from a computer or external control system supporting the **CA-NET** protocol, or from the free EclerCOMM Manager Application software.

See the manual of the **CA-NET** protocol for complete information about the details of the connection and the syntax of supported commands.

The specifications of the DAM614 serial connection are

- Baud rate: 9600 (Fixed, without auto-negotiation)
- Data bits: 8
- Parity: None
- Stop bits: 1
- Flow control: None
- Cable: standard RS-232 type, DB9-DB9 (pin-to-pin)

8. MAIN SCREEN/MIXER MODE/PRESET MANAGEMENT

8.1. MAIN SCREEN

After power on, the screen of the device displays the following information for a few seconds...



...then shows other information similar to this one:

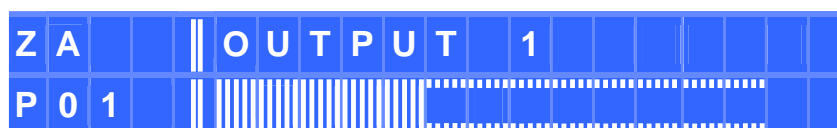

The information available on this screen, or **main screen**, is as follows (according to the example above):

- ZA: selected output zone for volume adjustment, selection of sources, etc. The available zones are ZA, ZB, ZC, ZD (all mono) or ZAB and ZCD if any pair of outputs is configured as a stereo zone
- OUTPUT 1: name of the output zone, by default OUTPUT n, but it is editable
- P01: number of the active preset or template. An asterisk to the right of the preset number indicates that this preset has been modified and not yet re-saved in the DAM614 memory (your changes will be lost when you shut down the computer if they are not saved before...)
- Horizontal Volume Bar: displays the output volume of the relevant zone; it can be directly altered by rotating its digital encoder. The LED indicator of the targeted output briefly flashes when its level is altered by rotating the digital encoder.

When a unit's input or output has been assigned to a volume control from an external wall panel (Wpa series or similar) connected to a REMOTE port of the DAM614 back panel, any modification of the physical remote panel position will briefly display the relevant volume setting on the LCD screen (before returning to the previous screen):

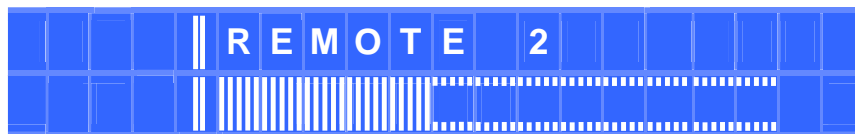

In addition, the input and output LED indicators light up on the front panel to give the following information:

8.1.1. Inputs:

- Input enabled for the output zone displayed on screen (LED On). A short press on the encoder switches its status (active/inactive)
- Input disabled for the output zone displayed on screen (LED Off). A short press on the encoder switches its status (active/inactive)

8.1.2. Outputs:

- Muted Output (MUTE = ON) (LED lit in red). A long press (> 2 seconds) on the encoder switches its status (unmuted/muted)
- Unmuted output (MUTE=OFF). A long press (> 2 seconds) on the encoder switches its status (unmuted/muted)

Note: you can press multiple encoders simultaneously to enable/disable their MUTE function

8.2. MIXER MODE

From the main screen of a zone (indicating its name and its output volume with a bar indicator), a short press of this output digital encoder switches your display to the MIXER mode:

Z		I 1	I 2	I 3	I 4	I 5	I 6
C		9 9	5 0	5 0	6 4	9 9	7 4

In this mode, it displays the mixing level of each input for the output displayed in the main screen (and in the upper left corner of the MIXER mode screen).

In the example above, we see the following information:

- The displayed output zone is ZONE C
- The mixing level of the inputs for this zone is 99 (INPUT1), 50 (INPUT2), 50 (INPUT3), 64 (INPUT4), 99 (INPUT5) and 74 (INPUT6)

This mix levels, concerning the inputs routed to the output ZONE C, are totally independent of the mixing volume of the same inputs for the 3 other zones of the device (A, B and D).

In this screen, you can change these mixing levels by rotating each input digital encoder. The LED indicator of the targeted input briefly flashes when its level is altered by rotating the digital encoder.

NOTES:

- Inputs, regardless of the mixing level shown in this screen, must be enabled (LED indicator lit in blue) for this zone mix to be effective. From this screen or from the zone volume main screen, you can press input keys to enable or disable the corresponding inputs in the mix
- From the MIXER screen, short presses on the same digital encoder (for the displayed output) will alternate between the MIXER screen and the main screen of the zone
- From the MIXER screen of a zone, you can switch to the MIXER screen of any other zone, briefly pressing a front panel ZONE encoder (A, B, C or D)

8.3. RECALL PRESET MENU

The DAM614 has 9 operating templates, which are used as a starting point for the configuration of an operating mode

- T1: 4 stereo inputs x 4 mono outputs
- T2: 4 stereo inputs x 2 stereo outputs
- T3: 4 stereo inputs x 1 stereo output + 2 mono outputs
- T4: 3 stereo inputs + 2 mono inputs x 4 mono outputs
- T5: 3 stereo inputs + 2 mono inputs x 2 stereo outputs
- T6: 3 stereo inputs + 2 mono inputs x 1 stereo output + 2 mono outputs
- T7: 2 stereo inputs + 4 mono inputs x 4 mono outputs
- T8: 2 stereo inputs + 4 mono inputs x 2 stereo outputs
- T9: 2 stereo inputs + 4 mono inputs x 1 stereo output + 2 mono outputs

Each system template automatically sets the operating and control mode of the channels and their settings, including the stereo linked group they pertain to. Example: in a stereo input or output configuration, the settings applied to the left channel are also automatically applied to the right channel, and vice versa

It is therefore possible to recall one of these templates, to edit its parameters and save the resulting setup as a PRESET or user memory.

System templates are displayed on the screen with the Txx prefix, where xx is the template number (between 01 and 09), followed by its name or LABEL. These files are not rewritable.

User presets are displayed on the screen with the Pxx prefix, where xx is the preset number (between 01 and 20), followed by its name or LABEL. The default name of all the user presets is USER PRESET, but it can be modified when you save one of them in memory.

The procedure for recalling a preset or a user template is the following one:

- From the main menu, briefly press SHIFT + RECALL
- The RECALL PRESET message is displayed and a preset number is flashing



- Select the preset or template using an encoder (ZONE A, B, C or D), and then select one of the two following options:
 - Press SHIFT + RECALL to validate the selection and activate the new preset, returning to the main screen, this time with data from the new active preset

Or

- Press SHIFT + CANCEL to cancel the selection and display again the preset from the selection list

Pressing SHIFT + EXIT at any point during the above process cancels the selection and returns the main screen.

8.4. SAVE PRESET MENU

Once you have edited the active preset or template, the procedure to save the current configuration in a user preset memory is the following one:

- From the main menu, press SHIFT + SAVE for at least 2 seconds (long press)
- The SAVE PRESET message is displayed and a preset number is flashing



- Select the user preset using the rotary control, and then select one of the two following options:
- SHIFT + SAVE to validate selection

Or

- SHIFT + CANCEL to cancel selection and show again the Start preset

Pressing SHIFT + EXIT at any point during the above process cancels the selection and returns the main screen.

If the selection is validated (SHIFT + SAVE) the following screen is displayed, allowing you to rename the destination preset:



To rename the preset:

- Edit the first character with an encoder (ZA or ZB)
- Press PARAMETER to select the next character to edit
- Select the new character with an encoder
- Etc...
- Pressing SHIFT + CANCEL cancels the previous changes and the display returns to the original state
- Once all the desired characters are edited, confirm the changes by pressing SHIFT + SAVE, displaying the PRESET SAVED message for a few seconds. The preset is stored in memory, but is not selected as active preset by the fact of having been saved
- The main screen returns, showing again the current preset at the time, and it is not necessarily the newly saved preset

Pressing SHIFT + EXIT at any point during the above process cancels the selection and returns the main screen.

The parameters stored in a preset are:

- All the input and output settings, including their names (labels)
- The setup for REMOTE ports 1, 2, 3 and 4 and the MUTE port (allowing to mute outputs via an external contact closure)

9. INPUT EDIT MENU

To open the edit menu for the settings of an input, you have to press SHIFT + INPUT_n, INPUT_n being the encoder corresponding to the desired input (1, 2, 3, 4, 5 or 6).

Once in the edit menu for an input, and in one of its pages, you can obtain the same page for another input by pressing SHIFT + INPUT_m, INPUT_m being the encoder for the new targeted input

The new edited values are activated in real time. You can cancel an edit operation, returning the value before editing, by pressing SHIFT + CANCEL.

To exit the Edit menu and return to the main screen:

- Press SHIFT + EXIT
- Press SHIFT + INPUT_n (the MUTE key of the input n currently edited)
- Stay 2 minutes without operating any control on the front panel

The next pages show the full structure and options of the menu for setting inputs.

NOTES:

1. INPUTs 3, 4 5 and 6 are dual (MICRO/LINE), and feature additional setup menus compared to inputs 1 and 2 (which are only LINE inputs):
 - High-pass filter (HP FILTER), with adjustable cut-off frequency between 50 and 150 Hz
 - TALKOVER: priority function of an audio input over other audio inputs
 - NOISE GATE. When this function is turned on, the input remains muted as long as no signal exceeds the activation threshold of the NOISE GATE, rejecting the background noise picked up by the microphone or the connected device
 - FEEDBACK SUPPRESSOR. It's an efficient system to reduce the risk of feedback loops (audio feedback or Larsen effect) when a microphone source is near the speaker(s) producing its signal, once amplified. When activated, this function slightly shifts the incoming signal frequency on the affected channel before sending it to the matrix mixer and then to the selected output. The shift is so slight that it is barely noticeable to the listener, especially when it occurs in the frequency range of the human voice. A few cycles (Hz) displacement is enough to greatly increase the system protection against possible feedbacks.

The adjustable parameters for the TALKOVER function are:

- Activation (ON/OFF)
The PAGER / DUCKER module is in charge of managing the routing of the signal with priority. **To avoid unexpected operation, do not manually route these signals.**
- MODE: DUCKER/PAGER (the latter only for Input 6). It has two operating modes:
 - DUCKER: performing after a signal detection (when the signal exceeds the detection threshold), it attenuates the signals that are assigned to the affected outputs (DUCKED OUTS)
 - PAGER (only Input 6): allows messages to be sent in real time from a MPAGE4 desktop paging station with a microphone
- Priority (PRIO): HIGH/LOW. An input featuring a TALKOVER function will be able to attenuate or mute the other inputs, with lower priority or without Talkover function, that are routed to the destination zones defined in its setup. If several inputs have the same priority level (several inputs with Talkover LOW or HIGH), the first input whose Talkover is engaged on a destination zone (its signal exceeding the detection threshold) disables the Talkover of the other inputs for the same zone, until the end of operation of the first Talkover (when its signal drops back below the activation threshold). Then the Talkover function is available again to be activated by an input that exceeds the threshold
- Attenuated Outputs (DUCKED OUTS): outputs affected by the TALKOVER function when this one operates in DUCKER mode. The symbol "o" under one of the zones on the screen indicates that this zone will be affected by DUCKER function
- Activation threshold (TLK THRESHD): trigger threshold of the Talkover function. The signal of the relevant input activates the Talkover function when it exceeds this threshold. This trigger level depends on the sensitivity setting for the input on the rear panel, but it is independent of the INPUT VOLUME adjustment made on the device (only available in DUCKER mode, since in PAGER mode the function is activated by pressing the PAGE button on the MPAGE4 console)
- Attenuation (DEPTH): attenuation applied by the function, when triggered, on the rest of the signals sent to the affected zone)
- Attack Time (ATTACK): the time it takes the Talkover function to act from the moment the signal exceeds the trigger threshold
- Hold Time (HOLD): time during which the Talkover function remains active, once triggered and once the signal falls back under the trigger

threshold (only available in mode DUCKER, since in PAGER mode the function remains active as long as the PAGE button is pressed on the MPAGE4 console)

- Release Time (RELEASE): time that it takes the Talkover function to stop performing, progressively recovering previous levels of input signals for the affected zone, after the Hold time
- Chime melody or "ding-dong" + playback volume: brief melody that plays when the Talkover function is activated, in PAGER mode only (two melodies are available)

Adjustable parameters for the NOISE GATE function are:

- Activation (ON/OFF)
- Activation Threshold (NG THRESHOLD). Defines the input signal level below which the signal is attenuated with an amount indicated by DEPTH (closed gate)
- Attack Time (ATTACK). Determines the amount of time between the passing of the threshold and the cancellation of the attenuation applied to the input signal (open gate)
- Hold Time (HOLD): amount of time the gate stays open (without attenuation) once the signal falls back below the detection threshold.
- Release Time (RELEASE). Determines the time it takes to close the gate again after the hold time

2. The COPY FROM – PASTE TO operation copies all the settings from the source input to the destination input, except for its name (LABEL)

Front panel INPUTS setup

To edit an INPUT setup, press & hold the SHIFT key and the INPUT1, 2, 3, 4, 5 or 6 encoder. You will then enter into the INPUTs setup menu. Press SHIFT + EXIT or wait 2 minutes to exit the setup mode. Once in the setup mode of an input, press SHIFT + INPUTx encoder to switch to the current setup menu (same config screen) of the new INPUTx input.

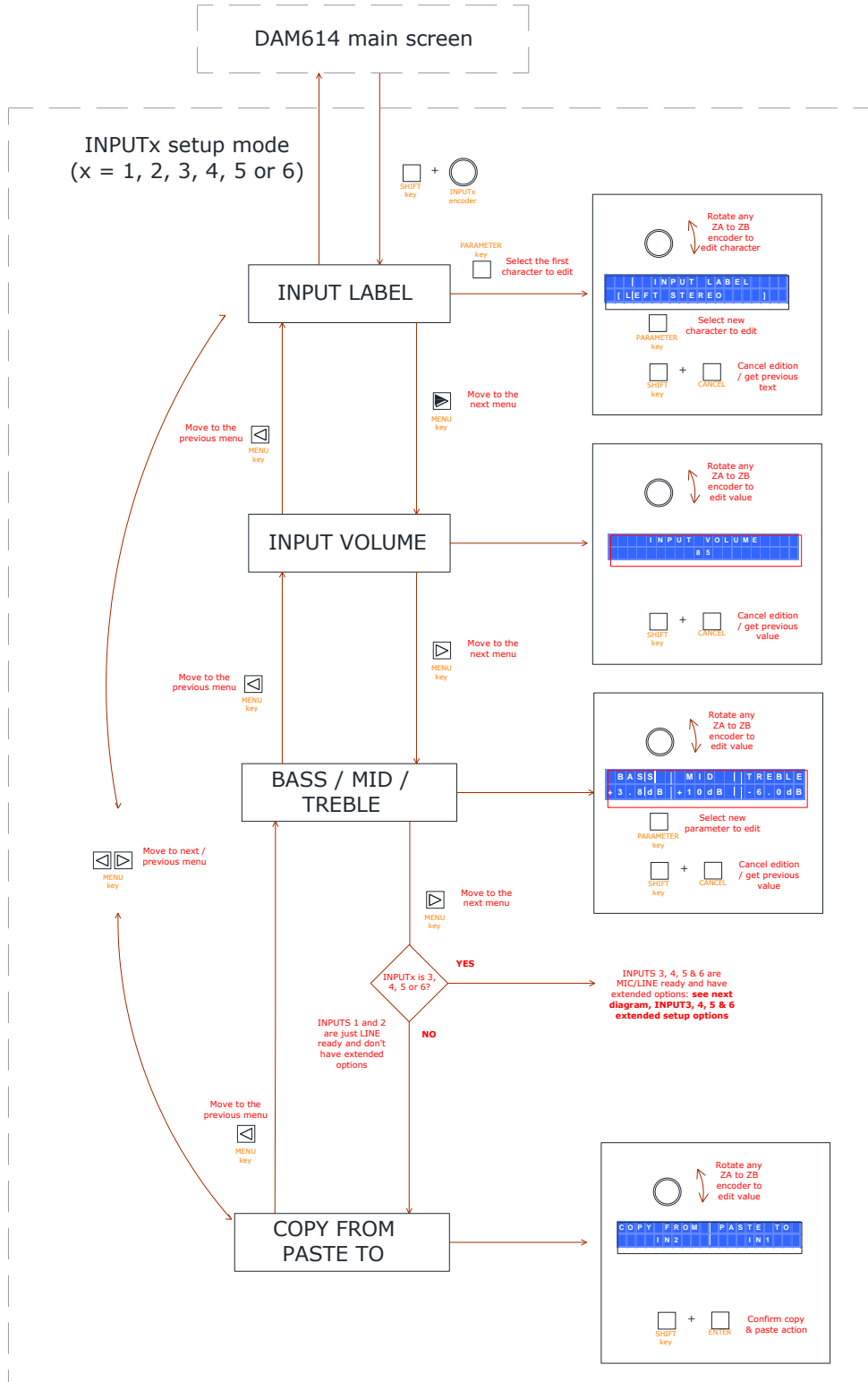

INPUTS 3, 4, 5 & 6 extended options setup

As INPUT3, 4, 5 and 6 are dual (MIC/LINE) inputs they do have extended options when compared to INPUTs 1 and 2 (just stereo LINE inputs).

This fact involves additional configuration menus and options, shown in the next diagram

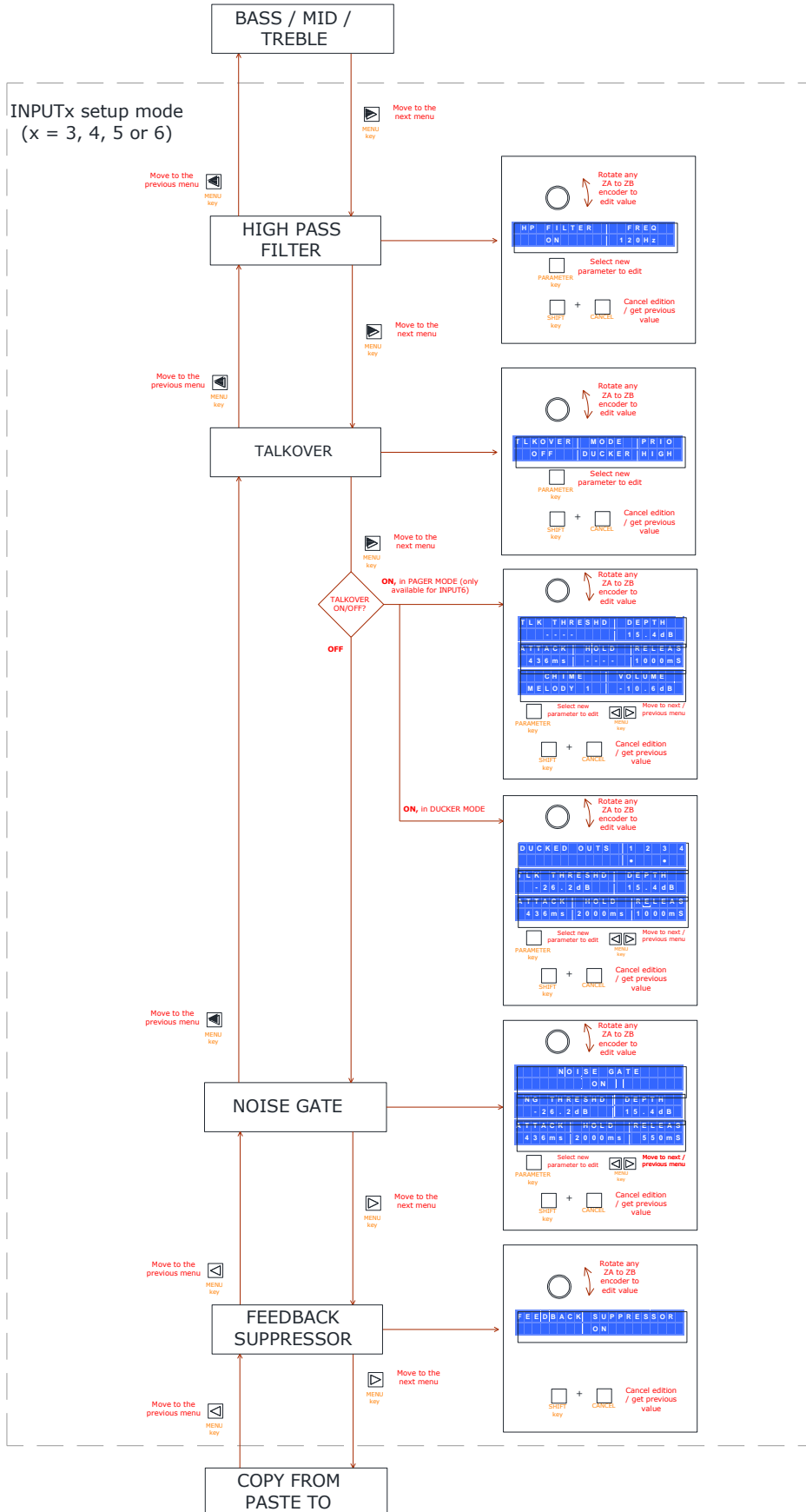

10. OUTPUT EDIT MENU

To open the edit menu for the settings of an output, you have to press SHIFT + OUTPUT_n, OUTPUT_n being the OUTPUT encoder corresponding to the desired output (ZONE A, B, C or D).

Once in the edit menu for an output, and in one of its pages, you can obtain the same page for another output by pressing SHIFT + OUTPUT_m, OUTPUT_m being the encoder for the new targeted output.

The new edited values are activated in real time. You can cancel an edit operation, returning the value before editing, by pressing SHIFT + CANCEL.

To exit the Edit menu and return to the main screen:

- Press SHIFT + EXIT
- Press SHIFT + OUTPUT_n (the encoder of the currently edited output)
- Stay 2 minutes without operating any control on the front panel

The next page shows the full structure and options of the menu for setting outputs.

NOTES:

1. The crossover filter applied to each output can be of high-pass (HP) or low-pass (LP) type, both with a Butterworth profile and a slope of 12 dB/octave, and a cut-off frequency adjustable between 20 Hz and 20 kHz
2. The graphic equalizer applied to each output has a setting of ± 10 dB for each of the 10 available bands:
 - 31.5 Hz
 - 63 Hz
 - 125 Hz
 - 250 Hz
 - 500 Hz
 - 1 kHz
 - 2 kHz
 - 4 kHz
 - 8 kHz
 - 16 kHz
3. The COPY FROM – PASTE TO operation copies all the settings from the source output to the destination output, except for its name (LABEL)
4. The compressor available on each output behaves as a limiter when the compression RATIO is **inf:1**.

Front panel OUTPUTS setup

To edit an OUTPUT setup, press & hold SHIFT key and the OUTPUT ZONE A, B, C or D encoder. You will then enter into the OUTPUTS setup menu. Press SHIFT + EXIT or wait 2 minutes to exit the setup mode. Once in the setup mode of an input, press SHIFT + another OUTPUT ZONE encoder to move to the current setup menu of the new OUTPUT.

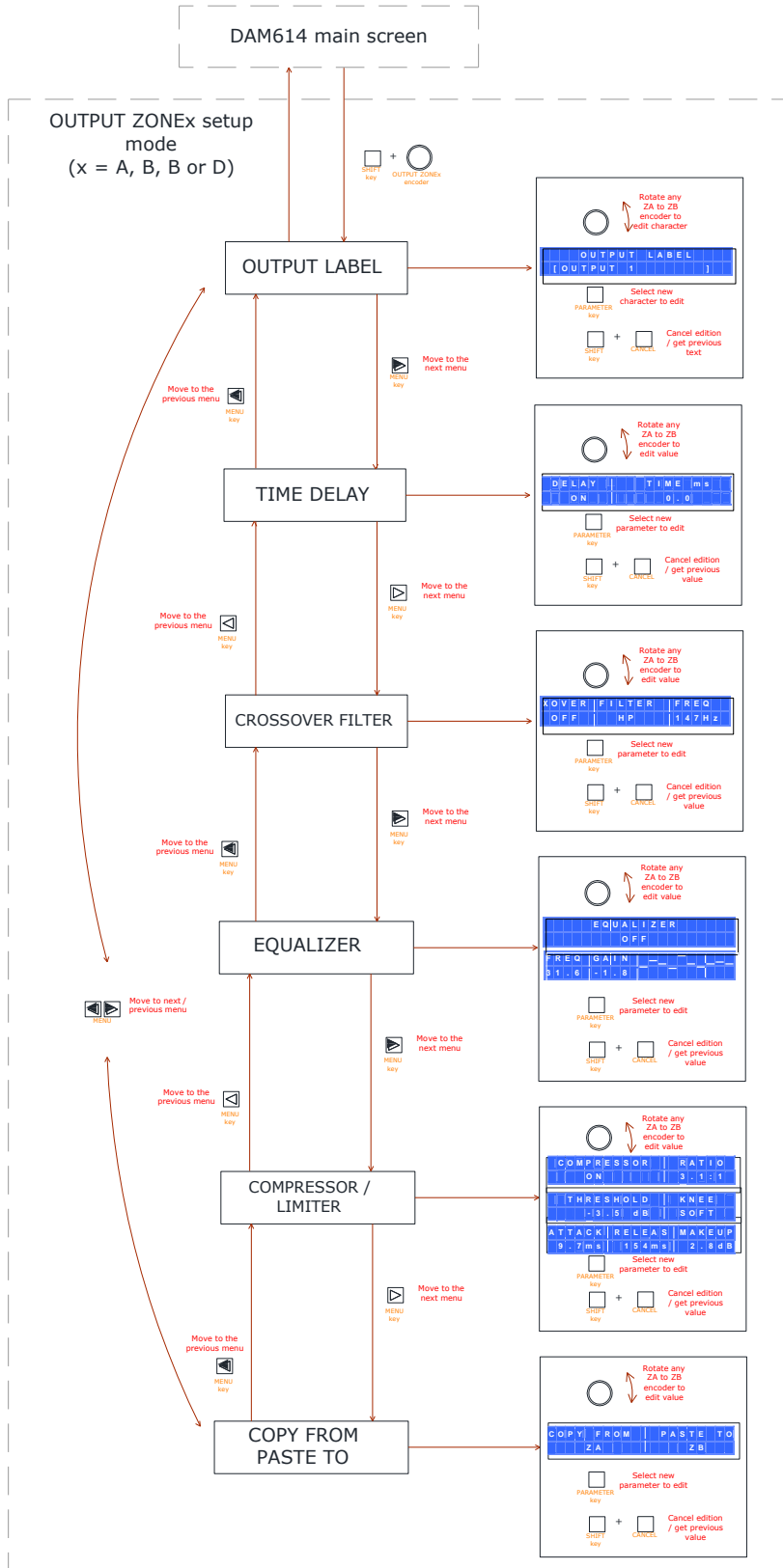

11. SETUP MENU

The DAM614 features a general setup menu (hereinafter SETUP menu), or parameters that globally affect the unit, such as the functions assigned to the REMOTE ports, the MUTE port management, the LCD display management, etc.

To open the SETUP menu you have to simultaneously press and hold down the left and right MENU keys. Pressing these two keys simultaneously first opens the Password protection screen to lock the front panel (see paragraph 10):

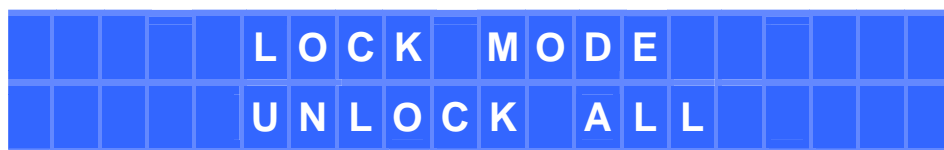

When this screen appears, and if you want to access the SETUP menu (instead of accessing the password protection management, as described in paragraph 10), then you must **press the right MENU key**.

The new edited values are activated in real time. You can cancel an edit operation, returning the value before editing, by pressing SHIFT + CANCEL.

To exit the Edit menu and return to the main screen:

- Press SHIFT + EXIT
- Stay 2 minutes without operating any control on the front panel

The next page shows the full structure and options of the SETUP menu.

NOTES:

1. Each of the REMOTE ports 1 to 4 can be connected to a WpaVOL-SR wall panel or similar, which has two rotary controls: a 5-way selector (0, 1, 2, 3 and 4) and a volume control. Each REMOTE port can be programmed to operate in one of the following modes:
 - ALL DISABLED: REMOTE port disabled, no function
 - IN VOLUME:
 - The volume control acts on the overall volume of the inputs. It is necessary to use the REMOTE INPUTS menu to determine the inputs that will be affected
 - The selector is disabled

- ZONE VOLUME:
 - The volume control acts on the overall volume of the outputs. It is necessary to use the REMOTE OUTPUTS menu to determine the outputs that will be affected
 - The selector is disabled
- IN SELECTOR:
 - The selector acts as an input selector: it allows you to choose between OFF and up to a maximum of 4 of the 6 available inputs, for the outputs to which it is assigned. It is necessary to determine the inputs that will be part of the selection options (REMOTE INPUTS menu) and the outputs that will be affected by the selection (REMOTE OUTPUTS menu)
 - The volume control is disabled
- IN SELECTOR+IN LEVEL:
 - The selector acts as an input selector: it allows you to choose between OFF and up to a maximum of 4 of the 6 available inputs, for the outputs to which it is assigned. It is necessary to determine the inputs that will be part of the selection options (REMOTE INPUTS menu) and the outputs that will be affected by the selection (REMOTE OUTPUTS menu)
 - The volume control acts on the volume of the crossing point between the input currently chosen with the selector and each of the affected outputs (this allows the same input source to be heard with a customized and independent volume for each output zone)
- IN SELECTOR+ZONE VOL:
 - The selector acts as an input selector: it allows you to choose between OFF and up to a maximum of 4 of the 6 available inputs, for the outputs to which it is assigned. It is necessary to determine the inputs that will be part of the selection options (REMOTE INPUTS menu) and the outputs that will be affected by the selection (REMOTE OUTPUTS menu)
 - The volume control acts on the overall volume of the outputs. It is necessary to use the REMOTE OUTPUTS menu to determine the outputs that will be affected

- PRESET: P1-P5:
 - The selector of the remote panel allows you to recall the first five DAM614 presets, P01 to P05. Only one of the REMOTE ports can be assigned to this option: once this option is assigned to one of them, it disappears from the selection menu of the other REMOTE ports
 - The volume control is disabled
- PRESET: P1-P5+ ZONE VOL:
 - The selector of the remote panel allows you to recall the first five DAM614 presets, P01 to P05. Only one of the REMOTE ports can be assigned to this option: once this option is assigned to one of them, it disappears from the selection menu of the other REMOTE ports
 - The volume control acts on the overall volume of the outputs. It is necessary to use the REMOTE OUTPUTS menu to determine the outputs that will be affected
- MATRIX VOLUME:
 - The volume control acts as a group control on the volume of the crossing point between one or more inputs and one or more outputs. This allows to control the volume of one or more sources in one or more zones from a single wall panel. It's important to note that when the crossing point of an input is assigned to an output for a REMOTE port, the same combination can't be assigned to another REMOTE port simultaneously
 - The selector is disabled

WARNING: when a REMOTE port is programmed to perform the preset recall, it is vital that all the presets targeted by the same port are programmed for the same function. Otherwise, a preset recalled from a REMOTE port could have its preset recall function turned off, and it would be then impossible to recall a new preset from the same REMOTE port

2. In the assignment menu of the REMOTE ports to the inputs or outputs volume control, the signs displayed under the number of an input or output have the following meanings:
 - Blank = input or output not assigned to a remote port
 - ● = Remote port assigned to the input or output
 - X = Incompatible selection, because it has already been assigned to another remote port
3. In the EXTERNAL MUTE assignment menu, it is possible to select which unit outputs will be muted when (and while) an external contact closure is detected at the MUTE port (normally open) of the back panel:
 - ● = Output affected by the EXTERNAL MUTE function
 - (blank) = Output not affected by the EXTERNAL MUTE function
4. When the AUTOLOAD PRESET 1 option is set to "YES", the device will automatically reload the preset number 1 after each power cycle, immediately after the start sequence e controls.
5. The LCD display adjustment menu (LCD MODE) allows you to adjust the operating mode of the display on standby, that is to say after a few seconds without any action on the front panel keys. Available modes are NORMAL (always on), DIMMED and OFF. In standby mode, any action on a front panel control temporarily returns the LCD display to its normal state (turned on); it turns back to sleep mode after a few seconds without action on the controls.

SETUP MENU

To enter the SETUP menu press & hold MENU left & right front keys.
 When the LOCK MODE MENU appears, press MENU right key to really enter SETUP menu.
 Press SHIFT + EXIT or wait 2 minutes to exit the setup mode.

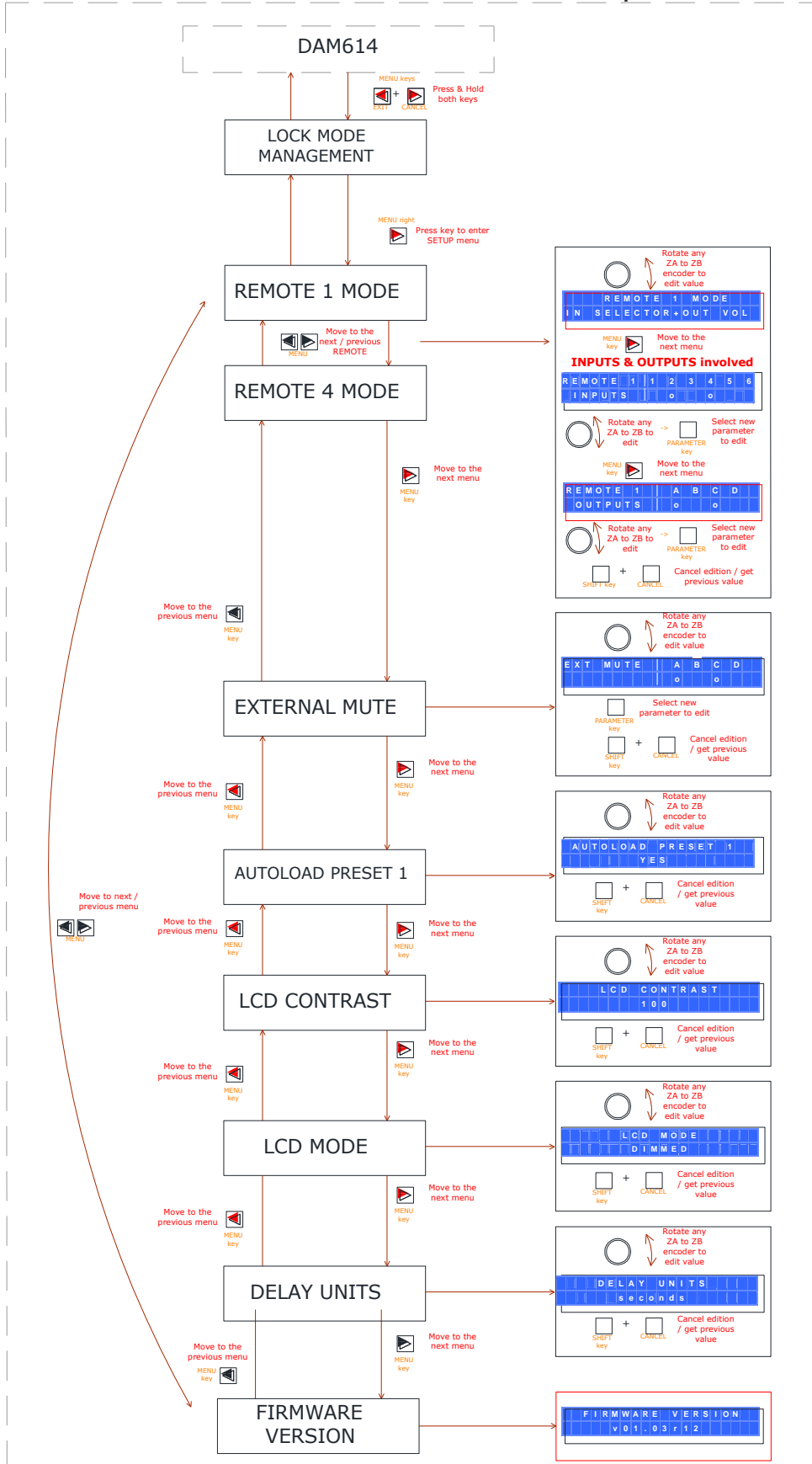

12. FRONT PANEL LOCK

The DAM614 has a front panel lockout feature, protecting the unauthorized access to the device with a password.

The locking feature has four operating modes:

- UNLOCK ALL: Lock function disabled, allowing access to all functions and menus of the equipment
- LOCK ALL: the lock is enabled, until an alphanumeric password is entered. The front panel controls are disabled, needing access to the lock menu to enter the password and re-enable them.
- UNLOCK OUTS: the lock is enabled, until an alphanumeric password is entered. The front panel controls are disabled, except for the MUTE keys and the output volume control, needing access to the lock menu to enter the password and re-enable them.
- UNLOCK INS&OUTS : the lock is enabled, until an alphanumeric password is entered. The front panel controls are disabled, except for the MUTE keys and the output volume control, as well as the input selection and the MIXER mode (input levels for each output), needing access to the lock menu to enter the password and re-enable them.

To access the lock menu, you have to press simultaneously the left and right MENU keys for 2 seconds, until the next screen appears on the LCD display:



Using the rotary control, it is possible to change the desired locking mode and then press SHIFT + ENTER to confirm the selection. If you select one of the three password protected modes (LOCK ALL, UNLOCK OUTS or UNLOCK INS&OUTS), the next screen prompts you to enter the lock password:



Using an encoder (ZA to ZB), edit the selected character, and using the PARAMETER key, select the next character to edit. Finally, press SHIFT + ENTER to validate the entered password.

In the password edit mode, you can cancel an edit operation, bringing the initial password back, by pressing SHIFT + CANCEL. Pressing SHIFT + CANCEL for five seconds erases all the characters of the password, to start the edition from scratch.

At any time it is possible to leave the lock menu by pressing SHIFT + EXIT.

Once in one of the password protected locking modes (LOCK ALL, UNLOCK OUTS ó UNLOCK INS&OUTS), the equipment displays the following screen if you press any disabled front panel control:



To re-enable the front panel controls, it is necessary to enter the stored password. To do this, access the lock menu (left and right MENU keys simultaneously for 2 seconds). The following screen is displayed:



Enter the password and press SHIFT + ENTER to validate it.



The equipment will be temporarily unlocked, until it remains 2 minutes without any activity on the front panel or returns to the lock menu (left and right MENU simultaneously for 2 seconds) to confirm or modify the lock mode, in which case it will go back to the password request (the same or a new one), which will be active starting from your validation (SHIFT + ENTER).

To permanently unlock the equipment, access the lock menu and select the UNLOCK ALL mode as new locking mode.

13. CLEANING

The control panel must not be cleaned with any dissolvent, abrasive or petroleum derived substance else paint and silk-printing could be damaged.

Whenever cleaning should be necessary use a soft cloth slightly wet with water and neutral liquid soap. Be careful that no liquid gets into the unit through its orifices. Never use sharp or erosive objects to scratch the control panel.

14. DIAGRAMS

14.1. FUNCTIONS LIST

1. INPUT 1 minijack connector
2. Rotary encoder INPUT 1/2/3/4/5/6
3. Input indicator light
4. Front panel LCD display
5. Setup key, MENU / EXIT
6. Setup key, MENU / SHIFT
7. Setup key, MENU / CANCEL
8. Setup key, PARAM / ENTER
9. Rotary encoder OUTPUT
10. OUTPUT indicator light
11. RCA input connectors
12. MIC/LINE input
13. Input sensitivity setting
14. MIC/LINE selector
15. MIC/LINE input
16. Input sensitivity setting
17. MIC/LINE selector
18. MIC/LINE input
19. Input sensitivity setting
20. MIC/LINE selector
21. MIC/LINE input
22. Input sensitivity setting
23. MIC/LINE selector
24. RJ-45 connector, PAGER
25. Remote volume silencing control, MUTE
26. RJ-45 connector, REMOTE
27. ZONE A/B/C/D amplified outputs
28. Remote control, RS-232 port
29. External DC power supply connector
30. Power button

14.2. FUNCTION DIAGRAM

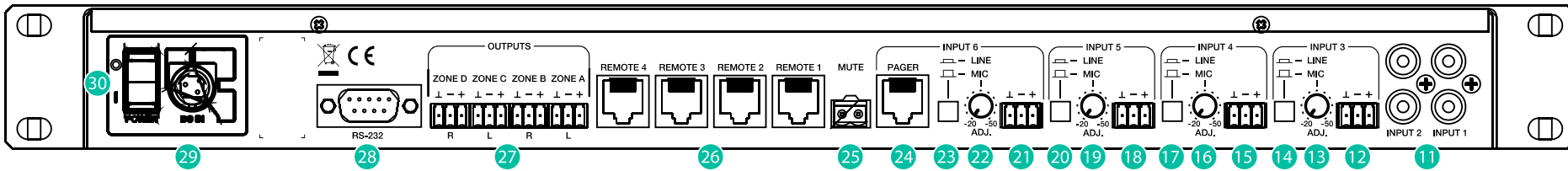
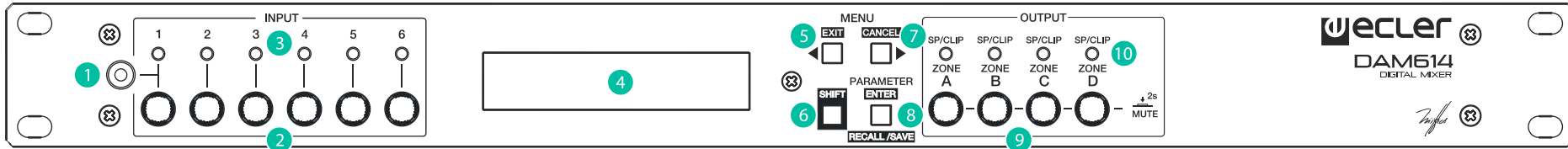

15. TECHNICAL CHARACTERISTICS

DAM614

INPUT 1, 2 (LINE)	
Sensitivity	0 / -6dBV Internal jumper adjust. 0dBV factory default
Input impedance	>13k
Input connector	RCA female
INPUT 3, 4, 5, 6 (MIC)	
Sensitivity	-20 / -50dBV External potentiometer adjust
Input impedance	>24k electronically balanced
CMRR	>55dB (20Hz ÷ 20kHz)
Input connector	Terminal block (Symmetrical)
Phantom Voltage	+17,5 VDC (Internal jumper)
INPUT 3, 4, 5, 6 (LINE)	
Sensitivity	0 / -6dBV Internal jumper adjust. 0dBV factory default
Input impedance	>24k electronically balanced
CMRR	>55dB (20Hz ÷ 20kHz)
Input connector	Terminal block (Symmetrical)
ZONE OUTPUTS	
Nominal output level	0dBV
Output impedance	300Ω electronically balanced
Output connector	Terminal block (Symmetrical)
A/D & D/A	24bit / 48kHz
FREQUENCY RESPONSE	<10Hz ~ 20kHz (+0dB/ -0.5dB)
OUTPUT NOISE FLOOR (FFT)	>110dB (from 20Hz to 20kHz)
THD + NOISE	< 0.0058% (1kHz, 1Vrms)
CROSSTALK	>90dB, 20Hz ÷ 20kHz
INPUT EQ	
Type	Baxandall 3 ways EQ
Gain	-10dB ~ +10dB in 0.1dB steps
Frequency	Low 200Hz Mid 1kHz High 6.3kHz
INPUT 3, 4, 5, 6 TALKOVER EQ	
Type	Assignable to any output zone. 2 priority levels
Modes	Ducker / Pager (only input 6)
Threshold	-80 / +12dBV
Depth	0 ~ 80dB
Attack time	5 ~ 2000ms
Hold time	10 ~ 3000ms
Release time	50 ~ 3000ms
Chime (only input 6)	ON / OFF. Variable volume. Two different melodies

INPUT 3, 4, 5, 6 NOISE GATE	
Threshold	-80 / +12dBV
Depth	0 ~ 80dB
Attack time	0.1 ~ 500ms
Hold time	10 ~ 3000ms
Release time	10 ~ 1000ms
INPUT 3, 4 OTHER OPTIONS	
Feedback supressor	Frequency shifter type.
High pass filter (hum & pop suppressor)	50 ~ 150 Hz 12dB/oct Butterworth
ZONE OUTPUT EQ	
Type	10 band EQ
Filters	Adaptable Q to achieve maximum flat response
Gain	-10dB ~ +10dB step 0.1dB
Frequencies	31, 63, 125, 250, 500, 1k, 2k, 4k, 8k, 16k Hz
ZONE OUTPUT CROSSOVER FILTERS	
Type	Low & High Pass Butterworth 12 dB/oct
Frequency	20Hz ÷ 20kHz
ZONE OUTPUT COMPRESSOR	
Threshold	-36 / +12dBV
Ratio	1:1 ~ 1:inf (LIMITER)
Knee	Hard / Soft
Attack time	0.1 ~ 500ms
Release time	10 ~ 1000ms
Make-up gain	0dB ~ +10dB
ZONE OUTPUT DELAY	
Delay Time	10 ~ 1000ms (10 ~ 343,4m)
Units	Milliseconds, seconds, centimeters, meters
EXTERNAL MUTE	
Configuration	Normally open. Assignable to any output zone
REMOTE CONTROLS	
Remote type	WPaVOL-SR. Up to 4 remotes
Configuration	Input volume Zone volume Input selector Preset selector
GENERAL	
DC supply	±17,5 VDC
Mains	100-240VAC + External PSU 17,5VDC
Power consumption	12W
Dimensions WxHxD	482,6x44x120mm 19x1.7x4.7 in.
Weight	2,00 kg 4.4 lb

16. CONFIGURATION DIAGRAM

JUMPERS FACTORY ADJUST

PHANTOM:	ON
Input 1/2 Sensitivity:	0dB
Input 3 Sensitivity (LINE L):	0dB
Input 3 Sensitivity (LINE R):	0dB
Input 4 Sensitivity (LINE L):	0dB
Input 4 Sensitivity (LINE R):	0dB

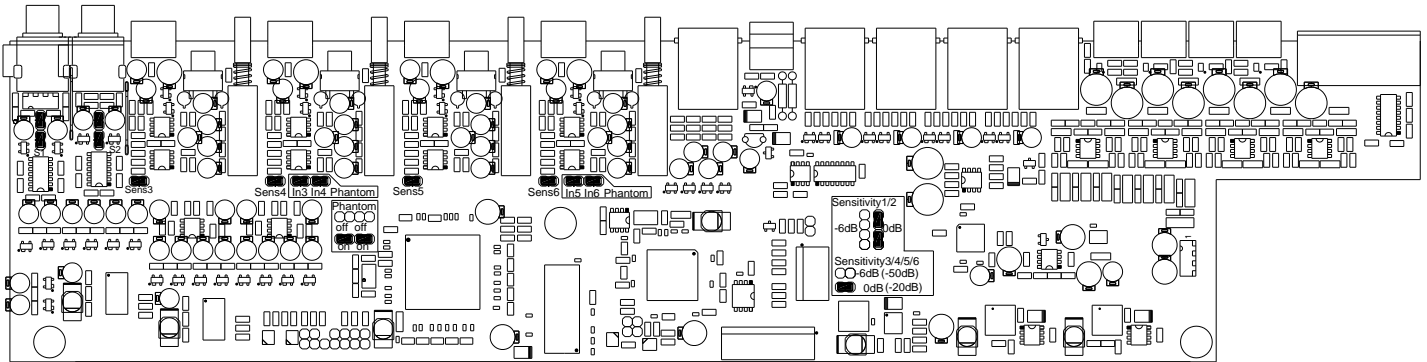

17. BLOCK DIAGRAM

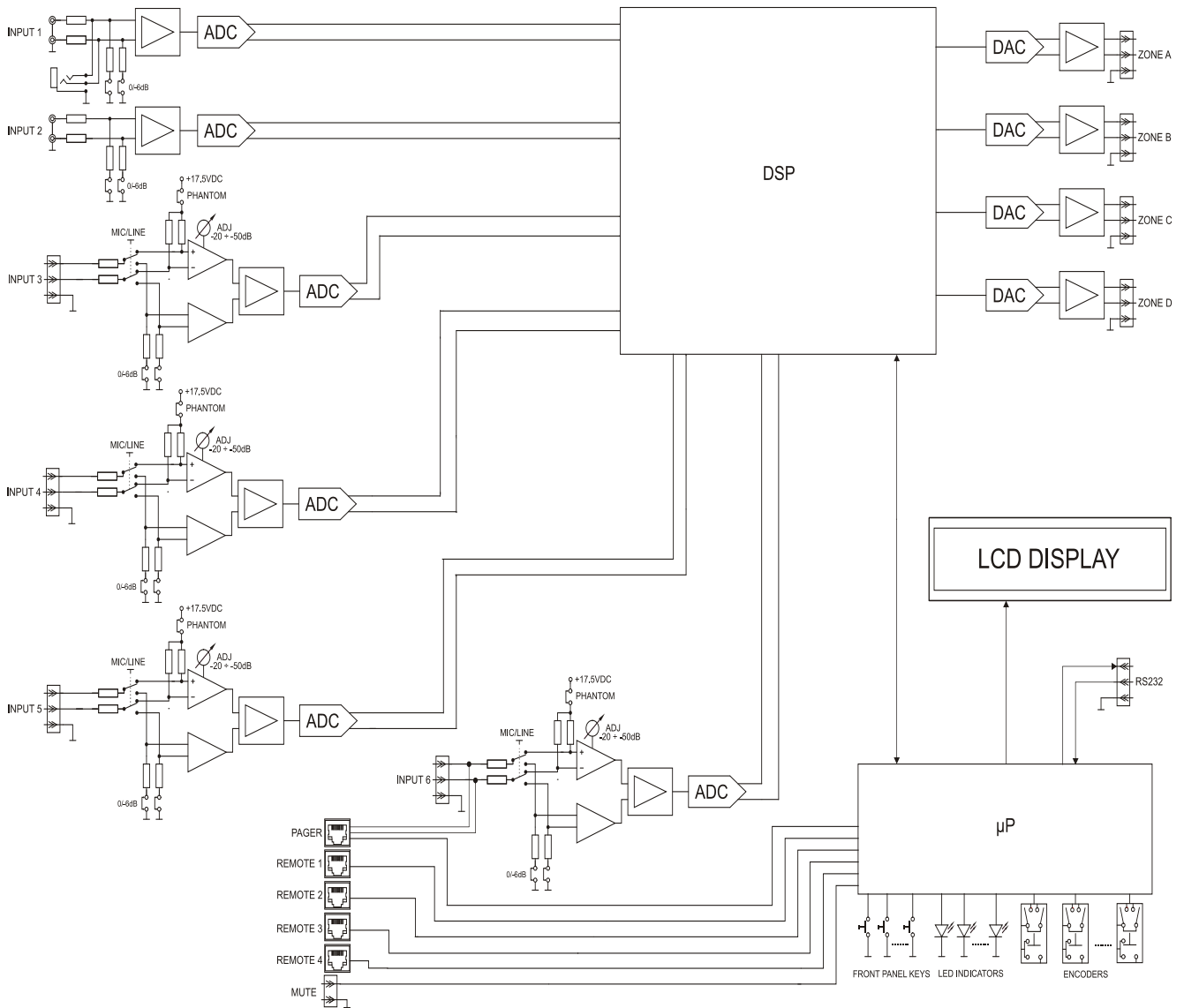

18. CA-NET RS-232 Remote Control Protocol

The built-in RS-232 port in the rear panel of the CA and DAM series devices allows for an external device communication via a serial connection. This kind of connection uses a syntax which is very similar to the one used in the Ecler TP-NET protocol: it lets a client device get from and/or set the values of several parameters of a CA / DAM device (for instance, the DAM614 audio digital mixer), like volumes, mutes, equalisation tones, etc.

The RS-232 serial communication must fulfil the following specifications:

Baud rate:	9600 (fixed, no auto-negotiation)
Data bits:	8
Parity:	None
Stop bits:	1
Flow control:	None

It's not allowed to have more than one simultaneous access from several clients to the same CA / DAM device using the RS-232 connection.

The protocol is simple and direct, syntax-friendly, making it easy to read, write and modify the generated code. It is based on messages with no begin delimiter: each message is self-delimited by the RS-232 packet size, which is defined with a maximum of **80 ASCII characters**, and always including the character **LF (0x0A)** at the end of each message. All the messages must be written in **CAPITAL LETTERS**.

To let some control systems (like EXTRON®, CRESTRON®, AMX®, RTI®, VITY®, MEDIALON®, etc.) process the messages more easily, the CA / DAM device adds the character **LF (0x0A)** at the end of each message it sends. This way the client of the CA / DAM device can buffer the received messages to process them, when required. The CA / DAM device can also handle several messages received in a single RS-232 packet by using the **LF** delimiter.

The available messages are built with one or more fields separated with blank spaces (= blank space):

<TYPE> [PARAM1] [PARAM2] [PARAM3] [PARAM4][LF]

The first field (**TYPE**) defines the **message type** and then, the required parameters for it (each kind of message requires a given number of parameters). The field **TYPE** can have these values:

- **GET**
- **SET**
- **DATA**
- **ERROR**

At the end of this document, you'll find a table including all the available messages and their parameters for each model of CA-NET compatible device.

The **GET & SET** messages can be sent from the client (control system) to the CA / DAM device. The **DATA & ERROR** messages can just be sent from the CA / DAM device to the client.

The **SET** messages coming from a client device don't have an automatic acknowledgement with a **DATA** message sent from the CA / DAM device after it has processed the **SET** command. The client must update the values itself, sending the needed **GET** message to ask for a parameter's value when it requires confirmation from the device. On the other hand, when a local control in the CA / DAM unit occurs (for instance, using the front panel controls or an infrared remote control), the CA / DAM device will automatically send the associated **DATA** command via its RS-232 interface, to keep synchronisation with the client device.

NOTES for DAM614:

- **<RemoteMode>** parameter
 - Originally designed to connect WpaVOL-SR (or WPTOUCH) wall panels to the REMOTE ports in the DAM614: panels that include a volume control knob and a 5-position selector knob. The possible working modes (**REMOTE_MODE** command) of any of the 4 available remote ports (R1 to R4) in the unit are:
 - DISABLED
 - IN_VOL: volume control for one or several inputs (general input volume, affecting all the post processing)
 - ZONE_VOL: volume control for one or several zone outputs
 - IN_SEL: one input (source) selection for one or several output zones (with the 5 position selector)
 - IN_SEL_IN_LEVEL: one input (source) selection for one or several output zones (with the 5 position selector) + the control of the selected input's crosspoints level to the destination zones
 - IN_SEL_ZONE_VOL: one input (source) selection for one or several output zones (with the 5 position selector) + the control of the affected zones output volume
 - PRESET: a preset recovery, from P1 to P5 (with the 5 position selector)
 - PRESET_ZONE_VOL: a preset recovery, from P1 to P5 (with the 5 position selector) + volume control for one or several zone outputs
 - MATRIX_VOL:
- **PAGER / DUCKER** parameter for **TALKOVER_MODE** command:
 - INPUT 6 can be used with the Talkover feature in PAGER or DUCKER mode. PAGER mode requires an external paging station (MPAGE4) to select the destination zones and performing the paging (for **DAM614**).
 - INPUTs 3, 4 and 5 can be used with the Talkover feature just in DUCKER mode (for **DAM614**).

DAM614

TYPE	PARAM1	PARAM2	PARAM3	PARAM4	DESCRIPCIÓN
GET	ALL				Dumps current device status (with DATA messages)
	INFO_MODEL				Gets the Device model name
	INFO_VERSION				Gets the current Firmware Version
	AUTOLOAD_PRESET1				Gets the current AUTOLOAD_PRESET1 at Startup function
	PRESET_NUMBER				Gets the current PRESET number
	PRESET_NAME	<Preset=P1:P20> <Preset=T1:T9>			Gets a certain PRESET (from P1 to P20) or TEMPLATE (from T1 to T9) name
	REMOTE_MODE	<Remote=R1:R4>			Gets the working mode for a certain REMOTE port (from R1 to R4)
	REMOTE_INPUTS	<Remote=R1:R4>			Gets the list of inputs affected by the working mode of a certain REMOTE port (from R1 to R4)
	REMOTE_ZONES	<Remote=R1:R4>			Gets the list of outputs affected by the working mode of a certain REMOTE port (from R1 to R4)
	DISPLAY_MODE				Gets the current LCD DISPLAY MODE
	LCD_CONTRAST				Gets the current LCD DISPLAY CONTRAST level
	EXT_MUTE_ZONES				Gets the outputs to be muted by an external contact closure, connected to the MUTE port
	IN_LABEL	<Input=l1:l6>			Gets the current LABEL (name) for the specified INPUT
	IN_STEREO	<Input=l3:l6>			Gets the current STEREO link status (ON or OFF) for INPUTs 3 and 4
	IN_MUTE	<Input=l1:l6>			Gets the current MUTE status (ON or OFF) for the specified INPUT
	IN_VOL	<Input=l1:l6>			Gets the current VOLUME for the specified INPUT (general input volume, affecting all the post processing)
	IN_BASS	<Input=l1:l6>			Gets the current BASS tone LEVEL for the specified INPUT
	IN_MID	<Input=l1:l6>			Gets the current MIDDLE tone LEVEL for the specified INPUT
	IN_TREBLE	<Input=l1:l6>			Gets the current TREBLE tone LEVEL for the specified INPUT
	HPF_ACTIVE	<Input=l3:l6>			Gets the current HIGH PASS FILTER status (ON or OFF) for the specified INPUT
HPF_FREQUENCY	<Input=l3:l6>			Gets the current HIGH PASS FILTER frequency (Hz) for the specified INPUT	

FBS_ACTIVE	<Input=I3:I6>			Gets the current FEEDBACK SUPPRESSOR feature status (ON or OFF) for the specified INPUT
GATE_ACTIVE	<Input=I3:I6>			Gets the current NOISE GATE status (ON or OFF) for the specified INPUT
GATE_THRESHOLD	<Input=I3:I6>			Gets the current NOISE GATE THRESHOLD LEVEL (dBx10) for the specified INPUT
GATE_DEPTH	<Input=I3:I6>			Gets the current NOISE GATE DEPTH (attenuation when gate is closed, dBx10) for the specified INPUT
GATE_ATTACK	<Input=I3:I6>			Gets the current NOISE GATE ATTACK TIME (milliseconds x10) for the specified INPUT
GATE_HOLD	<Input=I3:I6>			Gets the current NOISE GATE HOLD TIME (milliseconds x10) for the specified INPUT
GATE_RELEASE	<Input=I3:I6>			Gets the current NOISE GATE RELEASE TIME (milliseconds x10) for the specified INPUT
TALKOVER_ACTIVE	<Input=I3:I6>			Gets the current TALKOVER status (ON or OFF) for the specified INPUT
TALKOVER_MODE	<Input=I3:I6>			Gets the TALKOVER function working mode (PAGER or DUCKER) for the specified INPUT
TALKOVER_PRIORITY	<Input=I3:I6>			Gets the current TALKOVER PRIORITY level (LOW or HIGH) for the specified INPUT
TALKOVER_ZONES	<Input=I3:I6>			Gets the current TALKOVER assignment to outputs (ZONES) for the specified INPUT
TALKOVER_THRESHOLD	<Input=I3:I6>			Gets the current TALKOVER THRESHOLD LEVEL (dBx10) for the specified INPUT
TALKOVER_DEPTH	<Input=I3:I6>			Gets the current TALKOVER DEPTH (attenuation, dBx10) for the specified INPUT
TALKOVER_ATTACK	<Input=I3:I6>			Gets the current TALKOVER ATTACK TIME (milliseconds x10) for the specified INPUT
TALKOVER_HOLD	<Input=I3:I6>			Gets the current TALKOVER HOLD TIME (milliseconds x10) for the specified INPUT
TALKOVER_RELEASE	<Input=I3:I6>			Gets the current TALKOVER RELEASE TIME (milliseconds x10) for the specified INPUT

CHIME_MELODY	<Input=I3:I6>			Gets the current CHIME MELODY selected for the TALKOVER function in PAGER mode
CHIME_VOL	<Input=I3:I6>			Gets the current CHIME MELODY VOLUME (dBx10) adjusted for the TALKOVER function in PAGER mode
XSELECT	<Input=I1:I6>	<Zone=ZA:ZD>		Gets the current CROSSPOINT SELECT status (ON (input active) or OFF (input muted)) for the specified INPUT at the specified output zone
XLEVEL	<Input=I1:I6>	<Zone=ZA:ZD>		Gets the current CROSSPOINT LEVEL (mix level) for the specified INPUT at the specified output zone
ZONE_LABEL	<Zone=ZA:ZD>			Gets the current LABEL (name) for the specified output zone
ZONE_STEREO	<Zone=ZA:ZD>			Gets the current STEREO link status (ON or OFF) the specified output zone
ZONE_MUTE	<Zone=ZA:ZD>			Gets the current MUTE status (ON or OFF) for the specified output zone
ZONE_VOL	<Zone=ZA:ZD>			Gets the current VOLUME for the specified output zone
GEQ_ACTIVE	<Zone=ZA:ZD>			Gets the current GRAPHICAL EQUALIZER status (ON or OFF) for the specified output zone
GEQ_GAIN	<Zone=ZA:ZD>	<Band=B1:B10>		Gets the current GAIN (dBx10) of one BAND (B1 to B10) of the GRAPHICAL EQUALIZER for the specified output zone
XOVER_ACTIVE	<Zone=ZA:ZD>			Gets the current CROSSOVER FILTER status (ON or OFF) for the specified output zone
XOVER_TYPE	<Zone=ZA:ZD>			Gets the current CROSSOVER FILTER TYPE (LP or HP) for the specified output zone
XOVER_FREQUENCY	<Zone=ZA:ZD>			Gets the current CROSSOVER FILTER FREQUENCY (Hz) for the specified output zone
COMPRESSOR_ACTIVE	<Zone=ZA:ZD>			Gets the current COMPRESSOR status (ON or OFF) for the specified output zone
COMPRESSOR_THRESHOLD	<Zone=ZA:ZD>			Gets the current COMPRESSOR THRESHOLD LEVEL (dBx10) for the specified output zone
COMPRESSOR_RATIO	<Zone=ZA:ZD>			Gets the current COMPRESSOR RATIO (x100) for the specified output zone
COMPRESSOR_ATTACK	<Zone=ZA:ZD>			Gets the current COMPRESSOR ATTACK TIME (milliseconds x10) for the specified output zone
COMPRESSOR_RELEASE	<Zone=ZA:ZD>			Gets the current COMPRESSOR RELEASE TIME (milliseconds x10) for the specified output zone

COMPRESSOR_KNEE	<Zone=ZA:ZD>			Gets the current COMPRESSOR KNEE mode (SOFT or HARD) for the specified output zone
COMPRESSOR_GAIN	<Zone=ZA:ZD>			Gets the current COMPRESSOR GAIN (dBx10) for the specified output zone
DELAY_ACTIVE	<Zone=ZA:ZD>			Gets the current DELAY status (ON or OFF) for the specified output zone
DELAY_TIME	<Zone=ZA:ZD>			Gets the current DELAY TIME (milliseconds x10) for the specified output zone

TYP	PARAM1	PARAM2	PARAM3	PARAM4	DESCRIPCIÓN
SET	AUTOLOAD_PRESET1	ON/OFF			Sets the current AUTOLOAD_PRESET1 at Startup function
	PRESET_NUMBER	<Preset=P1:P20> <Preset=T1:T9>			Sets (loads) the current PRESET number
	LOAD_PRESET	<Preset=P1:P20> <Preset=T1:T9>			Sets (loads) the current PRESET number (same function as PRESET_NUMBER)
	SAVE_PRESET	<Preset=P1:P20>	"<Name>"		Saves the current configuration into a certain PRESET position (from P1 to P20) and with a certain LABEL, or name (between quotation marks to allow for blank characters in the label)
	REMOTE_MODE	<Remote=R1:R4>	<RemoteMode>		Sets the working mode for a certain REMOTE port (from R1 to R4). Valid working modes are: DISABLED, IN_VOL, ZONE_VOL, IN_SEL, IN_SEL_IN_LEVEL, IN_SEL_ZONE_VOL, PRESET, PRESET_ZONE_VOL
	REMOTE_INPUTS	<Remote=R1:R4>	<Inputs=I1:I6>		Sets the list of inputs affected by the working mode of a certain REMOTE port (from R1 to R4). Inputs parameter can include I1 to I6, separated by comma characters and no blank space (example: I1,I2,I3)
	REMOTE_ZONES	<Remote=R1:R4>	<Zones=ZA:ZD>		Sets the list of outputs affected by the working mode of a certain REMOTE port (from R1 to R4). Zones parameter can include ZA to ZD, separated by comma characters and no blank space (example: ZA,ZC,ZD)
	DISPLAY_MODE	<DisplayMode>			Sets the current LCD DISPLAY MODE (NORMAL or DIMMED or OFF)
	LCD_CONTRAST	<Contrast=0:100>			Sets the current LCD DISPLAY CONTRAST level
	EXT_MUTE_ZONES	<Zones=ZA:ZD>			Sets the list of outputs to be muted by an external contact closure, connected to the MUTE port. Zones parameter can include ZA to ZD, separated by comma characters and no blank space (example: ZA,ZC,ZD)
	IN_LABEL	<Input=I1:I6>	"<Label>"		Sets the current LABEL (name) for the specified INPUT (between quotation marks to allow for blank characters in the label)
	IN_STEREO	<Input=I3:I6>	ON/OFF		Sets the current STEREO link status (ON or OFF) for INPUTs 4 and 5

IN_MUTE	<Input=I1:I6>	ON/OFF		Sets the current MUTE status (ON or OFF) for the specified INPUT
IN_VOL	<Input=I1:I6>	<Volume=0:99>		Sets the current VOLUME for the specified INPUT (general input volume, affecting all the post processing)
IN_BASS	<Input=I1:I6>	<Gain=dBx10>		Sets the current BASS tone LEVEL for the specified INPUT
IN_MID	<Input=I1:I6>	<Gain=dBx10>		Sets the current MIDDLE tone LEVEL for the specified INPUT
IN_TREBLE	<Input=I1:I6>	<Gain=dBx10>		Sets the current TREBLE tone LEVEL for the specified INPUT
HPF_ACTIVE	<Input=I3:I6>	ON/OFF		Sets the current HIGH PASS FILTER status (ON or OFF) for the specified INPUT
HPF_FREQUENCY	<Input=I3:I6>	<Frequency=Hz>		Sets the current HIGH PASS FILTER frequency (Hz) for the specified INPUT
FBS_ACTIVE	<Input=I3:I6>	ON/OFF		Sets the current FEEDBACK SUPPRESSOR feature status (ON or OFF) for the specified INPUT
GATE_ACTIVE	<Input=I3:I6>	ON/OFF		Sets the current NOISE GATE status (ON or OFF) for the specified INPUT
GATE_THRESHOLD	<Input=I3:I6>	<Threshold=dBx10>		Sets the current NOISE GATE THRESHOLD LEVEL (dBx10) for the specified INPUT
GATE_DEPTH	<Input=I3:I6>	<Depth=dBx10>		Sets the current NOISE GATE DEPTH (attenuation when gate is closed, dBx10) for the specified INPUT
GATE_ATTACK	<Input=I3:I6>	<AttackTime=msx10>		Sets the current NOISE GATE ATTACK TIME (milliseconds x10) for the specified INPUT
GATE_HOLD	<Input=I3:I6>	<HoldTime=msx10>		Sets the current NOISE GATE HOLD TIME (milliseconds x10) for the specified INPUT
GATE_RELEASE	<Input=I3:I6>	<ReleaseTime=msx10>		Sets the current NOISE GATE RELEASE TIME (milliseconds x10) for the specified INPUT
TALKOVER_ACTIVE	<Input=I3:I6>	ON/OFF		Sets the current TALKOVER status (ON or OFF) for the specified INPUT
TALKOVER_MODE	<Input=I3:I6>	PAGER/DUCKER		Sets the TALKOVER function working mode (PAGER or DUCKER) for the specified INPUT
TALKOVER_PRIORITY	<Input=I3:I6>	LOW/HIGH		Sets the current TALKOVER PRIORITY level (LOW or HIGH) for the specified INPUT

TALKOVER_ZONES	<Input=l3:l6>	<Zones=ZA:ZD>		Sets the current TALKOVER assignment to outputs (ZONES) for the specified INPUT. Zones parameter can include ZA to ZD, separated by comma characters and no blank space (example: ZA,ZC,ZD)
TALKOVER_THRESHOLD	<Input=l3:l6>	<Threshold=dBx10>		Sets the current TALKOVER THRESHOLD LEVEL (dBx10) for the specified INPUT
TALKOVER_DEPTH	<Input=l3:l6>	<Depth=dBx10>		Sets the current TALKOVER DEPTH (attenuation, dBx10) for the specified INPUT
TALKOVER_ATTACK	<Input=l3:l6>	<AttackTime=msx10>		Sets the current TALKOVER ATTACK TIME (milliseconds x10) for the specified INPUT
TALKOVER_HOLD	<Input=l3:l6>	<HoldTime=msx10>		Sets the current TALKOVER HOLD TIME (milliseconds x10) for the specified INPUT
TALKOVER_RELEASE	<Input=l3:l6>	<ReleaseTime=msx10>		Sets the current TALKOVER RELEASE TIME (milliseconds x10) for the specified INPUT
CHIME_MELODY	<Input=l3:l6>	<ChimeMelody>		Sets the current CHIME MELODY selected for the TALKOVER function in PAGER mode
CHIME_VOL	<Input=l3:l6>	<Volume=dBx10>		Sets the current CHIME MELODY VOLUME (dBx10) adjusted for the TALKOVER function in PAGER mode
XSELECT	<Input=l1:l6>	<Zone=ZA:ZD>	ON/OFF	Sets the current CROSSPOINT SELECT status (ON (input active) or OFF (input muted)) for the specified INPUT at the specified output zone
XLEVEL	<Input=l1:l6>	<Zone=ZA:ZD>	<Level=0:99>	Sets the current CROSSPOINT LEVEL (mix level) for the specified INPUT at the specified output zone
ZONE_LABEL	<Zone=ZA:ZD>	"<Label>"		Sets the current LABEL (name) for the specified output zone (between quotation marks to allow for blank characters in the label)
ZONE_STEREO	<Zone=ZA:ZD>	ON/OFF		Sets the current STEREO link status (ON or OFF) the specified output zone
ZONE_MUTE	<Zone=ZA:ZD>	ON/OFF		Sets the current MUTE status (ON or OFF) for the specified output zone
ZONE_VOL	<Zone=ZA:ZD>	<Volume=0:99>		Sets the current VOLUME for the specified output zone
GEQ_ACTIVE	<Zone=ZA:ZD>	ON/OFF		Sets the current GRAPHICAL EQUALIZER status (ON or OFF) for the specified output zone

GEQ_GAIN	<Zone=ZA:ZD>	<Band=B1:B10>	<Gain=dBx10>	Sets the current GAIN (dBx10) of one BAND (B1 to B10) of the GRAPHICAL EQUALIZER for the specified output zone
XOVER_ACTIVE	<Zone=ZA:ZD>	ON/OFF		Sets the current CROSSOVER FILTER status (ON or OFF) for the specified output zone
XOVER_TYPE	<Zone=ZA:ZD>	LP/HP		Sets the current CROSSOVER FILTER TYPE (LP or HP) for the specified output zone
XOVER_FREQUENCY	<Zone=ZA:ZD>	<Frequency=Hz>		Sets the current CROSSOVER FILTER FREQUENCY (Hz) for the specified output zone
COMPRESSOR_ACTIVE	<Zone=ZA:ZD>	ON/OFF		Sets the current COMPRESSOR status (ON or OFF) for the specified output zone
COMPRESSOR_THRESHOLD	<Zone=ZA:ZD>	<Threshold=dBx10>		Sets the current COMPRESSOR THRESHOLD LEVEL (dBx10) for the specified output zone
COMPRESSOR_RATIO	<Zone=ZA:ZD>	<Ratio=x100>		Sets the current COMPRESSOR RATIO (x100) for the specified output zone
COMPRESSOR_ATTACK	<Zone=ZA:ZD>	<AttackTime=msx10>		Sets the current COMPRESSOR ATTACK TIME (milliseconds x10) for the specified output zone
COMPRESSOR_RELEASE	<Zone=ZA:ZD>	<ReleaseTime=msx10>		Sets the current COMPRESSOR RELEASE TIME (milliseconds x10) for the specified output zone
COMPRESSOR_KNEE	<Zone=ZA:ZD>	SOFT/HARD		Sets the current COMPRESSOR KNEE mode (SOFT or HARD) for the specified output zone
COMPRESSOR_GAIN	<Zone=ZA:ZD>	<Gain=dBx10>		Sets the current COMPRESSOR GAIN (dBx10) for the specified output zone
DELAY_ACTIVE	<Zone=ZA:ZD>	ON/OFF		Sets the current DELAY status (ON or OFF) for the specified output zone
DELAY_TIME	<Zone=ZA:ZD>	<DelayTime=msx10>		Sets the current DELAY TIME (milliseconds x10) for the specified output zone

TYPE	PARAM1	PARAM2	PARAM3	PARAM4	DESCRIPCIÓN
DATA	INFO_MODEL	<DeviceModel>			Shows the Device model name
	INFO_VERSION	<FirmwareVersion>			Shows the current Firmware Version
	AUTOLOAD_PRESET1	ON/OFF			Shows the current AUTOLOAD_PRESET1 at Startup function
	PRESET_NUMBER	<Preset=P1:P20> <Preset=T1:T9>			Shows the current PRESET number (active preset)
	PRESET_NAME	<Preset=P1:P20> <Preset=T1:T9>	"<Name>"		Shows a certain PRESET (from P1 to P20) or TEMPLATE (from T1 to T9) name
	PRESET_DONE	<Preset=P1:P20> <Preset=T1:T9>			Shows that the last SET LOAD_PRESET or SET PRESET_NUMBER command has been processed: the preset is loaded and active
	REMOTE_MODE	<Remote=R1:R4>	<RemoteMode>		Shows the working mode for a certain REMOTE port (from R1 to R4)
	REMOTE_INPUTS	<Remote=R1:R4>	<Inputs=I1:I6>		Shows the list of inputs affected by the working mode of a certain REMOTE port (from R1 to R4)
	REMOTE_ZONES	<Remote=R1:R4>	<Zones=ZA:ZD>		Shows the list of outputs affected by the working mode of a certain REMOTE port (from R1 to R4)
	DISPLAY_MODE	<DisplayMode>			Shows the current DISPLAY MODE
	LCD_CONTRAST	<Contrast=0:100>			Shows the current DISPLAY CONTRAST level
	EXT_MUTE_ZONES	<Zones=ZA:ZD>			Shows the list of outputs to be muted by an external contact closure, connected to the MUTE port
	IN_LABEL	<Input=I1:I6>	"<Label>"		Shows the current LABEL (name) for the specified INPUT
	IN_STEREO	<Input=I3:I6>	ON/OFF		Shows the current STEREO link status (ON or OFF) for INPUTs 4 and 5
IN_MUTE	<Input=I1:I6>	ON/OFF		Shows the current MUTE status (ON or OFF) for the specified INPUT	

IN_VOL	<Input=I1:I6>	<Volume=0:99>		Shows the current VOLUME for the specified INPUT (general input volume, affecting all the post processing)
IN_BASS	<Input=I1:I6>	<Gain=dBx10>		Shows the current BASS tone LEVEL for the specified INPUT
IN_MID	<Input=I1:I6>	<Gain=dBx10>		Shows the current MIDDLE tone LEVEL for the specified INPUT
IN_TREBLE	<Input=I1:I6>	<Gain=dBx10>		Shows the current TREBLE tone LEVEL for the specified INPUT
HPF_ACTIVE	<Input=I3:I6>	ON/OFF		Shows the current HIGH PASS FILTER status (ON or OFF) for the specified INPUT
HPF_FREQUENCY	<Input=I3:I6>	<Frequency=Hz>		Shows the current HIGH PASS FILTER frequency (Hz) for the specified INPUT
FBS_ACTIVE	<Input=I3:I6>	ON/OFF		Shows the current FEEDBACK SUPPRESSOR feature status (ON or OFF) for the specified INPUT
GATE_ACTIVE	<Input=I3:I6>	ON/OFF		Shows the current NOISE GATE status (ON or OFF) for the specified INPUT
GATE_THRESHOLD	<Input=I3:I6>	<Threshold=dBx10>		Shows the current NOISE GATE THRESHOLD LEVEL (dBx10) for the specified INPUT
GATE_DEPTH	<Input=I3:I6>	<Depth=dBx10>		Shows the current NOISE GATE DEPTH (attenuation when gate is closed, dBx10) for the specified INPUT
GATE_ATTACK	<Input=I3:I6>	<AttackTime=ms>		Shows the current NOISE GATE ATTACK TIME (milliseconds x10) for the specified INPUT
GATE_HOLD	<Input=I3:I6>	<HoldTime=ms>		Shows the current NOISE GATE HOLD TIME (milliseconds x10) for the specified INPUT
GATE_RELEASE	<Input=I3:I6>	<ReleaseTime=ms>		Shows the current NOISE GATE RELEASE TIME (milliseconds x10) for the specified INPUT
TALKOVER_ACTIVE	<Input=I3:I6>	ON/OFF		Shows the current TALKOVER status (ON or OFF) for the specified INPUT
TALKOVER_MODE	<Input=I3:I6>	PAGER/DUCKER		Shows the TALKOVER function working mode (PAGER or DUCKER) for the specified INPUT
TALKOVER_PRIORITY	<Input=I3:I6>	LOW/HIGH		Shows the current TALKOVER PRIORITY level (LOW or HIGH) for the specified INPUT
TALKOVER_ZONES	<Input=I3:I6>	<Zones=ZA:ZD>		Shows the current TALKOVER assignment to outputs (ZONES) for the specified INPUT

TALKOVER_THRESHOLD	<Input=I3:I6>	<Threshold=dBx10>		Shows the current TALKOVER THRESHOLD LEVEL (dBx10) for the specified INPUT
TALKOVER_DEPTH	<Input=I3:I6>	<Depth=dBx10>		Shows the current TALKOVER DEPTH (attenuation, dBx10) for the specified INPUT
TALKOVER_ATTACK	<Input=I3:I6>	<AttackTime=msx10>		Shows the current TALKOVER ATTACK TIME (milliseconds x10) for the specified INPUT
TALKOVER_HOLD	<Input=I3:I6>	<HoldTime=msx10>		Shows the current TALKOVER HOLD TIME (milliseconds x10) for the specified INPUT
TALKOVER_RELEASE	<Input=I3:I6>	<ReleaseTime=msx10>		Shows the current TALKOVER RELEASE TIME (milliseconds x10) for the specified INPUT
CHIME_MELODY	<Input=I3:I6>	<ChimeMelody>		Shows the current CHIME MELODY selected for the TALKOVER function in PAGER mode
CHIME_VOL	<Input=I3:I6>	<Volume=dBx10>		Shows the current CHIME VOLUME (dBx10) adjusted for the TALKOVER function in PAGER mode
XSELECT	<Input=I1:I6>	<Zone=ZA:ZD>	ON/OFF	Shows the current CROSSPOINT SELECT status (ON (input active) or OFF (input muted)) for the specified INPUT at the specified output zone
XLEVEL	<Input=I1:I6>	<Zone=ZA:ZD>	<Level=0:99>	Shows the current CROSSPOINT LEVEL (mix level) for the specified INPUT at the specified output zone
ZONE_LABEL	<Zone=ZA:ZD>	"<Label>"		Shows the current LABEL (name) for the specified output zone
ZONE_STEREO	<Zone=ZA:ZD>	ON/OFF		Shows the current STEREO link status (ON or OFF) the specified output zone
ZONE_MUTE	<Zone=ZA:ZD>	ON/OFF		Shows the current MUTE status (ON or OFF) for the specified output zone
ZONE_VOL	<Zone=ZA:ZD>	<Volume=0:99>		Shows the current VOLUME for the specified output zone
GEQ_ACTIVE	<Zone=ZA:ZD>	ON/OFF		Shows the current GRAPHICAL EQUALIZER status (ON or OFF) for the specified output zone
GEQ_GAIN	<Zone=ZA:ZD>	<Band=B1:B10>	<Gain=dBx10 >	Shows the current GAIN (dBx10) of one BAND (B1 to B10) of the GRAPHICAL EQUALIZER for the specified output zone
XOVER_ACTIVE	<Zone=ZA:ZD>	ON/OFF		Shows the current CROSSOVER FILTER status (ON or OFF) for the specified output zone

XOVER_TYPE	<Zone=ZA:ZD>	LP/HP		Shows the current CROSSOVER FILTER TYPE (LP or HP) for the specified output zone
XOVER_FREQUENCY	<Zone=ZA:ZD>	<Frequency=Hz>		Shows the current CROSSOVER FILTER FREQUENCY (Hz) for the specified output zone
COMPRESSOR_ACTIVE	<Zone=ZA:ZD>	ON/OFF		Shows the current COMPRESSOR status (ON or OFF) for the specified output zone
COMPRESSOR_THRESHOLD	<Zone=ZA:ZD>	<Threshold=dBx10>		Shows the current COMPRESSOR THRESHOLD LEVEL (dBx10) for the specified output zone
COMPRESSOR_RATIO	<Zone=ZA:ZD>	<Ratio=x100>		Shows the current COMPRESSOR RATIO (x100) for the specified output zone
COMPRESSOR_ATTACK	<Zone=ZA:ZD>	<AttackTime=msx10>		Shows the current COMPRESSOR ATTACK TIME (milliseconds x10) for the specified output zone
COMPRESSOR_RELEASE	<Zone=ZA:ZD>	<ReleaseTime=msx10>		Shows the current COMPRESSOR RELEASE TIME (milliseconds x10) for the specified output zone
COMPRESSOR_KNEE	<Zone=ZA:ZD>	SOFT/HARD		Shows the current COMPRESSOR KNEE mode (SOFT or HARD) for the specified output zone
COMPRESSOR_GAIN	<Zone=ZA:ZD>	<Gain=dBx10>		Shows the current COMPRESSOR GAIN (dBx10) for the specified output zone
DELAY_ACTIVE	<Zone=ZA:ZD>	ON/OFF		Shows the current DELAY status (ON or OFF) for the specified output zone
DELAY_TIME	<Zone=ZA:ZD>	<DelayTime=msx10>		Shows the current DELAY TIME (milliseconds x10) for the specified output zone

TYPE	PARAM1	PARAM2	PARAM3	PARAM4	DESCRIPCIÓN
INC/DEC	PRESET_NUMBER	<Count>			INCrements / DECrements the current active PRESET number
	IN_VOL	<Input=I1:I6>	<Count>		Increments / decrements a certain INPUT's current VOLUME. The increment applied is defined by the Count parameter (dBx10)
	IN_BASS	<Input=I1:I6>	<Count>		Increments / decrements a certain INPUT's current BASS tone LEVEL. The increment applied is defined by the Count parameter (dBx10)
	IN_MID	<Input=I1:I6>	<Count>		Increments / decrements a certain INPUT's current MIDDLE tone LEVEL. The increment applied is defined by the Count parameter (dBx10)
	IN_TREBLE	<Input=I1:I6>	<Count>		Increments / decrements a certain INPUT's current TREBLE tone LEVEL. The increment applied is defined by the Count parameter (dBx10)
	XLEVEL	<Input=I1:I6>	<Zone=ZA:ZD>	<Count>	Increments / decrements a certain CROSSPOINT current VOLUME (matrix level sent from one input to one output). The increment applied is defined by the Count parameter (dBx10)
	ZONE_VOL	<Zone=ZA:ZD>	<Count>		Increments / decrements a certain output ZONE current VOLUME. The increment applied is defined by the Count parameter (dBx10)
	GEQ_GAIN	<Zone=ZA:ZD>	<Band=B1:B10>	<Count>	Increments / decrements, in a certain output ZONE, the current GAIN for a certain GRAPHICAL EQUALIZER band. The increment applied is defined by the Count parameter (dBx10)

All product characteristics are subject to variation due to production tolerances. **NEEC AUDIO BARCELONA S.L.** reserves the right to make changes or improvements in the design or manufacturing that may affect these product specifications.

For technical queries contact your supplier, distributor or complete the contact form on our website, in [Support / Technical requests](#).

Motors, 166-168 08038 Barcelona - Spain - (+34) 932238403 | information@ecler.com | www.ecler.com