



Monitor

User Manual

Regulatory Information(For 50/55 Model)

FCC Information

Please take attention that changes or modification not expressly approved by the party responsible for compliance could void the user's authority to operate the equipment.

FCC compliance:This equipment has been tested and found to comply with the limits for a Class B digital device, pursuant to part 15 of the FCC Rules. These limits are designed to provide reasonable!protection against harmful interference in a residential installation. This equipment generates,uses and can radiate radio frequency energy and, if not installed and used in accordance with the instructions, may cause harmful interference to radio communications. However, there is no guarantee that interference will not occur in a particular installation. If this equipment does cause harmful interference to radio or television reception, which can be determined by turning the equipment off and on, the user is encouraged to try to correct the interference by one or more of the following measures:

- Reorient or relocate the receiving antenna.
- Increase the separation between the equipment and receiver.
- Connect the equipment into an outlet on a circuit different from that to which the receiver is connected.
- Consult the dealer or an experienced radio/TV technician for help.

FCC Conditions

This device complies with part 15 of the FCC Rules. Operation is subject to the following two conditions:

1. This device may not cause harmful interference.
2. This device must accept any interference received, including interference that may cause undesired operation.

EU Conformity Statement

 This product and - if applicable - the supplied accessories too are marked with "CE" and comply therefore with the applicable harmonized European standards listed under the EMC Directive 2014/30/EU, the LVD Directive 2014/35/EU, the RoHS Directive 2011/65/EU.

 2012/19/EU (WEEE directive): Products marked with this symbol cannot be disposed of as unsorted municipal waste in the European Union. For proper recycling, return this product to your local supplier upon the purchase of equivalent new equipment, or dispose of it at designated collection points. For more information see: www.recyclethis.info

 2006/66/EC (battery directive): This product contains a battery that cannot be disposed of as unsorted municipal waste in the European Union. See the product documentation for specific battery information. The battery is marked with this symbol, which may include lettering to indicate cadmium (Cd), lead (Pb), or mercury (Hg). For proper recycling, return the battery to your supplier or to a designated collection point. For more information see: www.recyclethis.info

Industry Canada ICES-003 Compliance

This device meets the CAN ICES-003(B)/NMB-003(B) standards requirements.

Regulatory Information(For 65 Model)

FCC Information

Please take attention that changes or modification not expressly approved by the party responsible for compliance could void the user's authority to operate the equipment.

FCC compliance:This equipment has been tested and found to comply with the limits for a Class A digital device, pursuant to part 15 of the FCC Rules. These limits are designed to provide reasonable protection against harmful interference when the equipment is operated in a commercial environment. This equipment generates, uses, and can radiate radio frequency energy and, if not installed and used in accordance with the instruction manual, may cause harmful interference to radio communications. Operation of this equipment in a residential area is likely to cause harmful interference in which case the user will be required to correct the interference at his own expense.

FCC Conditions

This device complies with part 15 of the FCC Rules. Operation is subject to the following two conditions:

1. This device may not cause harmful interference.
2. This device must accept any interference received, including interference that may cause undesired operation.

EU Conformity Statement

 This product and - if applicable - the supplied accessories too are marked with "CE" and comply therefore with the applicable harmonized European standards listed under the EMC Directive 2014/30/EU, the LVD Directive 2014/35/EU, the RoHS Directive 2011/65/EU.



2012/19/EU (WEEE directive): Products marked with this symbol cannot be disposed of as unsorted municipal waste in the European Union. For proper recycling, return this product to your local supplier upon the purchase of equivalent new equipment, or dispose of it at designated collection points. For more information see: www.recyclethis.info



2006/66/EC (battery directive): This product contains a battery that cannot be disposed of as unsorted municipal waste in the European Union. See the product documentation for specific battery information. The battery is marked with this symbol, which may include lettering to indicate cadmium (Cd), lead (Pb), or mercury (Hg). For proper recycling, return the battery to your supplier or to a designated collection point. For more information see: www.recyclethis.info

Industry Canada ICES-003 Compliance

This device meets the CAN ICES-003(A)/NMB-003(A) standards requirements.

This is a class A product and may cause radio interference in which case the user may be required to take adequate measures.

WARNING: This equipment is compliant with Class A of EN55032/CISPR 32.

In a residential environment this equipment may cause radio interference.

Applicable Models

This manual is applicable to 50/55/65 Inch Monitor.

Safety instructions

Pixel feature

This liquid crystal display product has ultrahigh color resolution. While it's effective pixels are up to 99.999% or higher, it is still possible that a dark spot or a bright spot (red, green or blue) constantly appears on the screen. This is the structure property (within the general industrial standard) of the display rather than a fault.

The monitor will appear picture crash then reboot if influenced by strong electrostatic interference, it may self-recovered or need manual recovered to original status.

Safety

Please read and understand all instructions before using the monitor safety. Damage resulting from nonobservance of the instructions is not covered by the warranty.

Be careful of electric shock and fire!

- Never make the monitor contact with rain or water. Never place a liquid container (e.g., a vase) near or on the monitor. Please disconnect the monitor's power immediately if a liquid is spilled on the monitor's surface or inside. Please contact the customer service center before using it again.
- Never put a monitor, remote controller, or battery near an open flame or other heat source (including direct sunlight). In order to avoid flame spread, always keep candles or other open flames away from monitors, remote controls, and batteries.



- Never insert any object into the ventilation slot or other openings on the monitor.
- Please make sure that the power line is not taut. The tightening of the power line will loose the power connections and produce sparks.

Beware of short circuit or fire!

- Do not expose the remote controller or battery in rain, water or overheated environment.
- Please avoid pulling the plug. Loose power plugs may spark or cause fire.

Watch out for personal injury or monitor damage!

- It is suggested that the monitor be carried by two people.
- When installing the monitor on the stand, please use only the chassis provided. Firmly fix the frame on the monitor. Put the monitor on a flat, flat surface that can withstand the total weight of the monitor and the chassis.
- When installing a monitor with wall mounting, please use only the wall mount bracket that can bear the weight of the monitor. Fix the wall mount mounting bracket on the wall that can withstand the total weight of the monitor and the wall mount bracket.
The company is not responsible for the accident, personal injury or loss caused by improper installation.

Be careful of hurting children!

Please follow the following precautions to avoid child injury due to monitor falling:

- Never place the monitor on a surface covered with a cloth or other material that can be pulled.
- Make sure that any part of the monitor is within the edge of the surface.
- When placing a monitor on a high furniture (such as a bookcase), the furniture and monitor must be fixed to the wall or the appropriate support.
- Tell children about the dangers of climbing furniture and touching monitors.

Beware of eating battery!

- The remote control of this product contains batteries. There is a risk that children might eat the batteries. Please keep them out of reach of children.

Watch out for overheating!

- Never install the monitor in the enclosed space. Always leave at least 4 inches or 10 centimeters of space around the monitor for ventilation. Make sure that curtains or other objects do not block the ventilation slot on the monitor.

Be careful! Don't break the monitor!

- Before you connect the monitor to the power outlet, make sure that the power voltage matches the value printed on the back of the monitor. If the voltage is different, don't connect the monitor to the power outlet.
- If the monitor is not used for a long time, please cut off the power supply.

Be careful of personal injury, fire or power line damage!

- Do not put the monitor or any object on the power line.
- As a disconnecting device, the power plug should be kept to operate conveniently.
- When the power line is disconnected, always hold the plug instead of pulling the cable.
- Before the thunderstorm comes, disconnect the monitor from the power outlet and the antenna. Never touch any part of a monitor, a power line, or an antenna in a thunderstorm.
- The wired network antenna connected to the equipment must be isolated from the protective grounding, otherwise it may cause fire and other dangers!

Watch out for hearing impairment!

- Avoid using headphones or earphones at high volume or for a long time.

Low temperature

- If the monitor is transported below 5°C, please open the package of the monitor. Wait for the monitor to adapt to the room temperature, and then connect the monitor to the power outlet.

This manual is for reference only, please refer to the actual machine.

1. Unpacking and installation

1.1. Unpacking

- This product is packed in a paper packing case and comes with standard accessories.
- Any other optional parts are individually packed.
- Considering the size and weight of the monitor, it is recommended to move this monitor by two persons.
- Please confirm that items are complete and intact after opening the packing case.

1.2. Items in the packing case

Please confirm that the packing case contains the following items:

- LCD monitor
- Remote control
- Instructions
- Power cord
- HDMI cable
- Bracket x 2



* The supplied power cord varies depending on destination.



Remote Control



User Manual

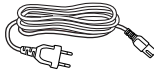

Power Cord



HDMI Cable



Bracket

Notes:

- For all other regions, the power cords shall be matched with the AC voltage of the power socket, conform to the regulations of the relevant laws of the countries/territories, and pass certification. (Types H05VV-F, 2G or 3G 0.75 or 1mm² shall be used.)
- You can keep the packing case and packaging materials for later transport of the monitor.

1.3. Installation precautions

- This product belongs to high-power-consumption products. Please always use the plug specially designed for this product. If you need to extend the wire, please consult your service provider.
- This product should be installed on a plane to avoid overturn. The rear part of this product should be kept away from the wall at a certain distance so as to maintain proper ventilation. This product shall not be installed in the kitchen, bathroom or any other locations with high humidity, to avoid shortening the service life of the electronic components.
- This product works only at an altitude below 3000m. If the installation site is higher than 3000m, some abnormalities may occur.

1.4. Installation for the base of the mounting desk:

Install the base:

1. Spread the protective film (wrapped on the monitor during packing) on the desk, and place the monitor with its front face down on the protective film (keep the trademark off the desk) to avoid scratching the screen.
2. Align the base according to the figure (distinguish the left and right supports). There are R and L marks on the base. Lock screws.
3. Lift the monitor and place it.

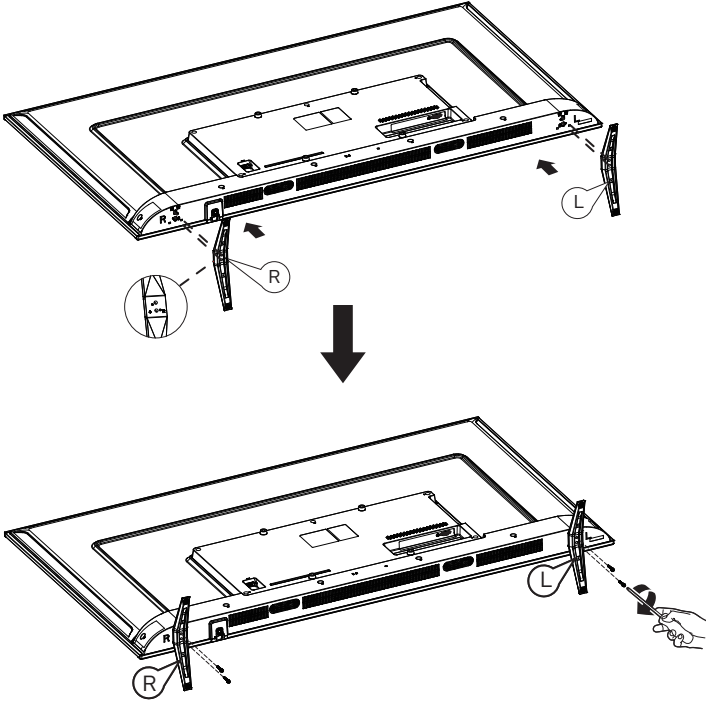

1.5. Hang the monitor on the wall

In order to install the monitor on the wall, you must prepare a set of standard wall-hanging kit (separately purchased). You are recommended to use the mounting plate which conforms to the TUV-GS and/or UL1678 standard.

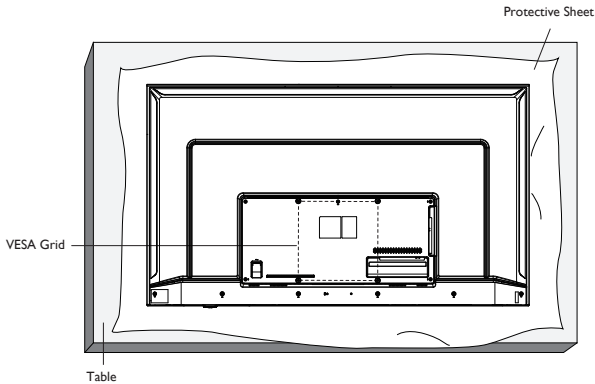

1. Spread a protective sheet which was wrapped around the display when it was packed on a flat surface. Lay the display face-down on the protective sheet to facilitate your operation without scratching the screen.
2. Ensure that you have all accessories necessary for any type of mounting (hanging rack, lifting rack, desk base, etc.).
3. Follow the instructions that come with the base mounting kit. Failure to follow correct mounting procedures could result in damage to the equipment or injury to the user or installer. Product warranty does not cover damage caused by improper installation.
4. For the wall-mounting kit, use M6 mounting screws (with a length 20 mm(50")/26mm(55") 25mm(65") longer than the thickness of the mounting bracket) and tighten them securely.

1.5.1. VESA grid plate

50"	200(H) x 200(V) mm
55"	200(H) x 200(V) mm
65"	300(H) x 300(V) mm

Caution:

Prevent the monitor from falling down:

- In the case of wall installation or suspended installation, it is recommended to use the metal assembling rack available on the market to install the monitor. Refer to the guide attached to the assembling rack for specific installation instructions.
- In order to lower the probability that the monitor falls down and results in personal injuries and property loss under the condition of earthquake or other natural disasters, please do consult the assembling rack manufacturer to confirm the installation position.

Table of contents

1.	Unpacking and installationviii	5.	Compatibility of the USB device 17
1.1.	Unpacking..... viii	6.	Input mode20
1.2.	Items in the packing case viii	7.	Cleaning and Troubleshooting.21
1.3.	Installation precautions viii	7.1.	Cleaning21
1.4.	Installation for the base of the mounting desk: ix	7.2.	Troubleshooting22
1.5.	Hang the monitor on the wall....x	8.	Technical specification..... 24
1.5.1.	VESA grid plate x		
2.	Parts and functions..... 2		
2.1.	Control panel2		
2.2.	Input/output terminal3		
2.3.	Remote Control4		
2.3.1.	General functions.....4		
2.3.2.	Install batteries into the remote control5		
2.3.3.	Maintenance of the remote control5		
2.3.4.	Working scope of the remote control6		
3.	Connect external devices7		
3.1.	Connect external devices (DVD/VCR/NVR)7		
3.1.1.	Use HDMI video input7		
3.2.	Connect PC7		
3.2.1.	Use HDMI input.....7		
3.2.2.	Use VGA input8		
3.3.	Connect USB8		
3.3.1.	Use USB device8		
4.	Operation..... 9		
4.1.	Play multimedia files from USB device9		
4.1.1.	Photo 10		
4.1.2.	Music 11		
4.1.3.	Movie 12		
4.1.4.	Text..... 13		
4.2.	Operation on the OSD menu: .14		

Ventilation requirements for enclosed space

In order to ensure normal heat dissipation, sufficient space from items to four sides shall be kept, as shown in the figure below.

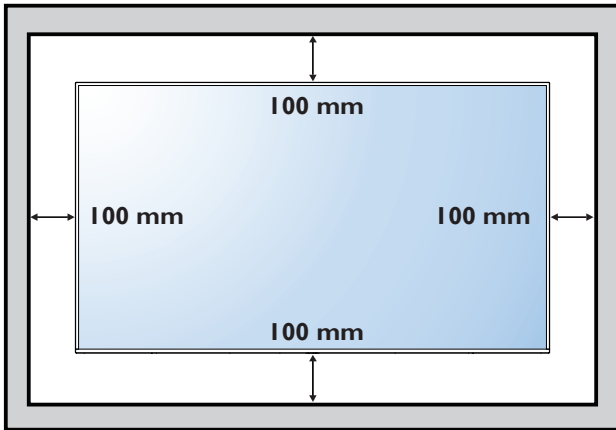

2. Parts and functions

2.1. Control panel

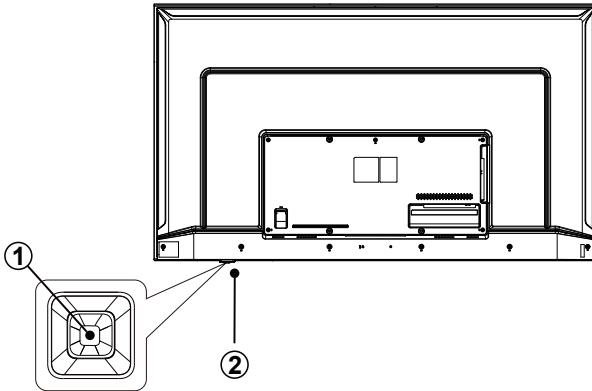

① Power button

Turn the display On or put the display to standby mode.

② Remote control sensor and power status indicator.

2.2. Input/output terminal

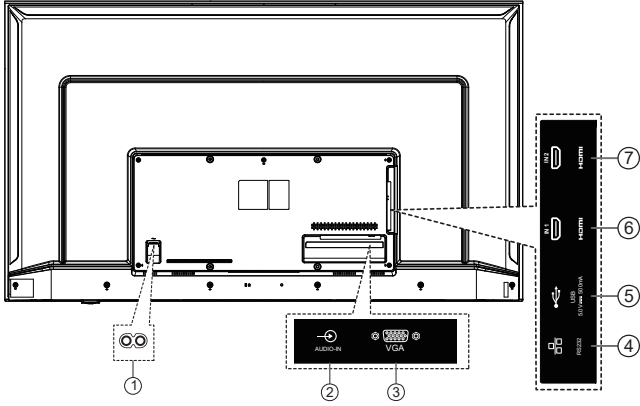

- ① **AC IN**
AC power input from the wall socket.
- ② **AUDIO IN**
Audio input for VGA source
- ③ **VGA IN**
VGA video input.
- ④ **RS232**
Receive command signals from the external RS232 device.
- ⑤ **USB port**
Connect to the USB storage device.
- ⑥ **HDMI 1/** ⑦ **HDMI 2**
HDMI 1 support HDMI 1.4, up to 4K @30Hz.
HDMI 2 support HDMI 2.0, up to 4K @60Hz.

2.3. Remote Control

2.3.1. General functions



① **[⏻] POWER button**

Turn on or turn off the display.

② **[Source] Button**

Channel switching, source key only supports switching (source).

③ **[CMS] button**

Reserved.

④ **[USB] button**

Go to USB source.

⑤ **[HDMI/PC] button**

Go to HDMI source.

⑥ **[⌚] Time button**

Reserved.

⑦ **[▶] PLAY button**

Control playback of media files.

⑧ **[MENU] SETTINGS button**

Enter the main menu, or return to previous menu or exit the main menu. The remote control buttons [up], [down], [left], [right] are movement, Under the menu setting, press the left and right buttons to enter the lower menu or adjust the parameters.

⑨ **[INFO] button**

Show Information OSD.

⑩ **[M] MUTE button**

Mute or restore volume.

⑪ **[↶] BACK button**

Signal source interface or menu interface: prompt "exit" and press RC [return] to exit.

⑫ **[Vol+] VOLUME button**

Turn up the volume.

⑬ **[Home] HOME button**

Reserved.

⑭ **[▲] [▼] [◀] [▶] NAVIGATION buttons**

Up, down, left and right operation key.

⑮ **[OK] button**

Press OK to display the message.

⑯ **[Vol-] Volume button**

Turn Down the volume.

⑰ **[Option] button**

Reserved.

⑱ **[Number] buttons**

Input figures or text.

⑲ **[Multi-View] button**

Reserved.

⑳ **[Help] button**

Reserved.

2.3.2. Install batteries into the remote control

The remote control is electrified by two pieces of 1.5V AAA batteries.

Install or replace batteries:

1. Install and push away the battery cover.
2. Place the batteries according to the marks (+) and (-).
3. Close the battery cover.

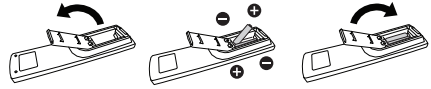

Caution:

Incorrect use of the batteries may result in liquid leak or explosion. Please do abide by the following instructions:

- To place the “AAA” batteries in, the marks (+) and (-) of each of the batteries shall correspond to the marks (+) and (-) in the battery compartment.
- Please do not use batteries of different types at the same time.
- Please do not use old and new batteries at the same time, otherwise the service life of the batteries will be shortened or liquid leak will occur.
- Take out the batteries immediately once the batteries are exhausted so as to avoid liquid leak in the battery compartment. ◦
Please do not touch exposed acid liquid of the batteries, or your skin will be injured.

Notes: Take out the batteries if the remote control is not used for a long time.

2.3.3. Maintenance of the remote control

- Protect the remote control against violent collision.
- Do not splash water or other liquid on the remote control. Wipe dry the remote control immediately if there is liquid thereon.
- Keep it away from heat and damp.
- Do not open the remote control except installing the batteries.

2.3.4. Working scope of the remote control

To press buttons on the remote control, please point the front of the remote control at the remote sensor on the monitor.

When the remote control is in use, the distance to the sensor on the monitor shall be smaller than 5m/16 inch, and the horizontal and vertical angles shall be smaller than 30 degrees.

Notes: The remote control may fail to work normally when sunlight or other strong light radiates on the remote sensor of the monitor or there is an obstacle between the remote and the remote sensor.

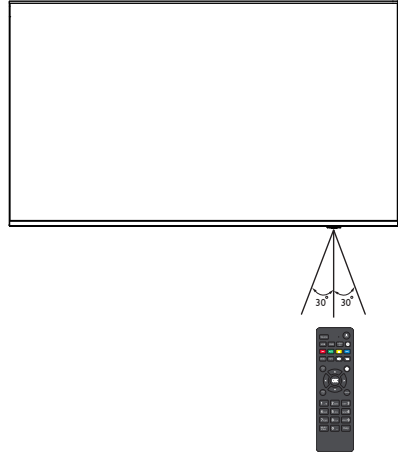

3. Connect external devices

3.1. Connect external devices (DVD/VCR/NVR)

3.1.1. Use HDMI video input

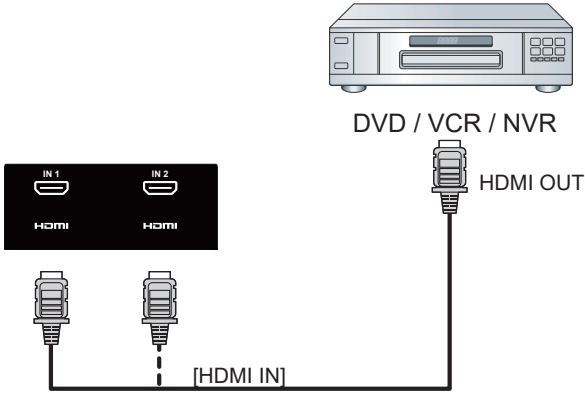

3.2. Connect PC

3.2.1. Use HDMI input

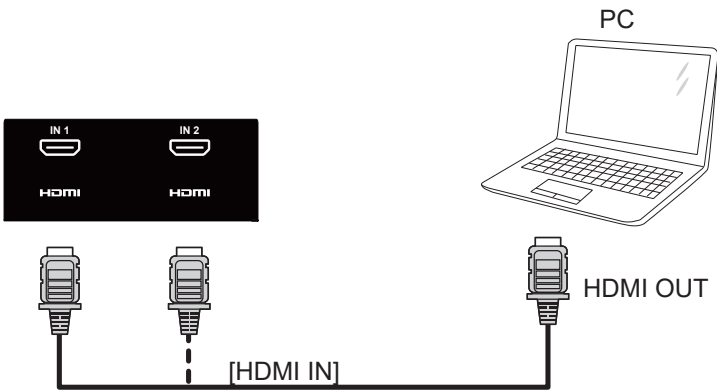

3.2.2. Use VGA input

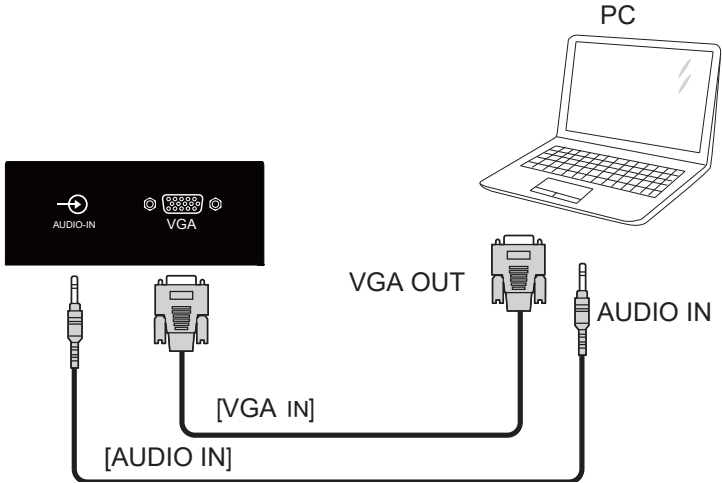

3.3. Connect USB

3.3.1. Use USB device

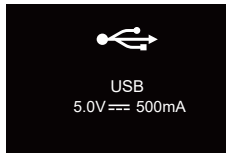

4. Operation

NOTE: The control button described in this section is mainly on the remote control unless specified otherwise.

4.1. Play multimedia files from USB device

1. Connect your USB device to the USB port on the display.

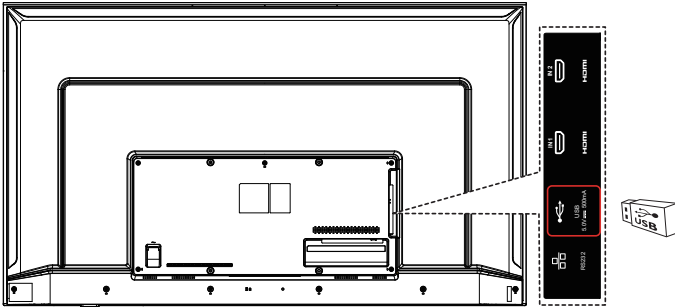

2. Press [**SOURCE**] button, choose **USB**, and press [**OK**] button.

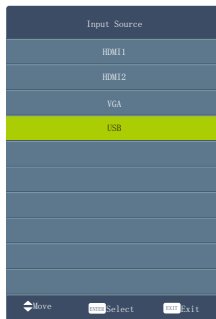

3. Press [**◀▶**] to select **Photo/Music/Movie/Text** icon and [**OK**] to enter the USB memory.

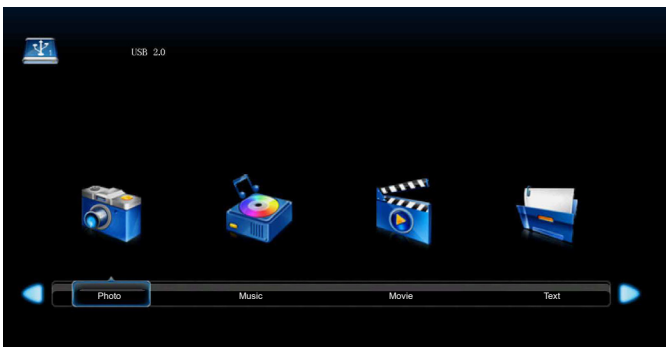

4. Follow the on-screen instruction to control the play option.

4.1.1. Photo

Select a picture file and press [OK] to view, and it will display all the pictures in the folder automatically. Press [OK] to display the following menu.

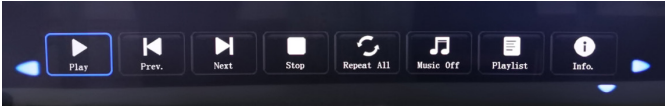

Play/Pause	Press "Play/Pause" button to paly or pause the slideshow.
Prev./Next	Press "Next/Prev." button to skip to view the photo which are seleced the photo.
Stop	Press "Stop" button to stop and return.
RepeatAll	Press to select the repeat mode: Repeat 1/ALL/None.
Music Off	Press to play or stop the background music.
Playlist	Press to view the list of pictures.
Info.	Press to display the information of the current picture (Resolution/ Size/Date/Time)
Rotate	Rotate counterclockwise.
Zoom in	Zoom the picture in.
Zoom out	Zoom the picture out.
Move view	Zoom out the picture first. Highlight the icon and press [OK], then press [▼/▲]& [◀/▶] to move the picture.

4.1.2. Music

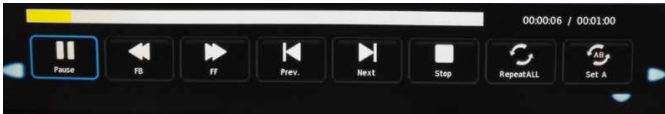

Play/Pause	Press to play or stop.
FB	Press to play slower.
FF	Press to play faster.
Prev.	Press to play the previous song.
Next	Press to play the next song.
Stop	Press to stop and return to folder interface.
RepeatAll	Press to select the repeat mode: Repeat 1/ALL/None.
SET A	Select AB mode.
Mute	Select "MUTE" mode: on or off .
Playlist	Seclect to display play list.
INFO.	Seclect to display the music information.
Goto time	Seclect to setup play time.

4.1.3. Movie

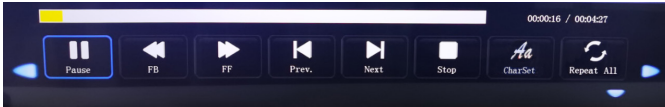

Play/Pause	Press to play or pause.
FB	Press to play slower.
FF	Press to play faster.
Prev.	Press to play the previous movie.
Next	Press to play the next movie.
Stop	Press to stop and back to folder interface.
Charset	Character set switching.
RepeatAll	Press to select the repeat mode: Repeat 1/ALL/None.
Set A	Select AB mode.
Playlist	Press to view the list of pictures.
INFO.	Press to display the information of the current movie.
Slow forward	Slow forward.
Step forward	Step forward.
Goto time	Select to setup play time.

4.1.4. Text

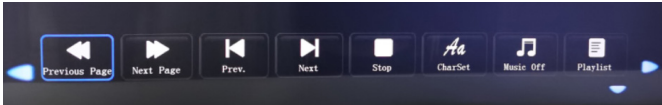

Prev Page	Press to the previous page.
Next Page	Press to the next page.
Prev.	Press to play previous text.
Next	Press to play next text.
Stop	Press to stop and back to folder interface.
Charset	Character set switching.
Music Off	Turn background music on or off.
Playlist	Press to view the list of texts.
INFO.	Press to display the information of the current movie.

4.2. Operation on the OSD menu:

Column 1	Column 2	Column 1, 3	Column 2, 3 or Column 2, 2	Remarks
Picture	Picture Mode	Security monitoring		Depend on HDMI 1/ HDMI 2
		Automatic		Depend on HDMI 1/ HDMI 2
		Bright		
		Standard		
		Soft		
		User		Sub items can be adjusted in user mode only, Grayed out in other modes.
	Color temp	Standard		Adjust different image modes, the default color temperature is the standard.(only user mode can be adjusted, other modes are grayed out)
		Warm		
		User		
		Cool		
	Noise Reduction	Off		1. It is not adjustable in computer channel or security monitoring mode, and the display proportion is point-to-point. 2. When entering video timing, noise suppression is adjustable. 3. USB source playing video noise is adjustable.
		Low		
		Middle		
		High		
		Default (default value: medium, gray)		
	Brightness	0 ... 100		Backlight adjustment.
	HDMI Mode	Auto		The reappearance rate is different under different separation rate and mode.
Video				
PC				
Sound	Treble	0 ... 100	50: default	In mute mode, when you press the key to adjust the sound and balance, the mute icon will disappear.
	Bass	0 ... 100	50: default	
	Balance	-50 ... +50	0: default	

TIME	Sleep Timer	Off, 10min, 20min, 30min, 60min, 90min, 120min, 180min, 240min		After setting the time, the device will automatically turn off at the time you set. Restart and return to the default value of off.
	Auto Sleep	Off, 3 hours, 4 hours, 5 hours		Turn off or select no device operation to automatically enter sleep time (3 hours, 4 hours, 5 hours). Default value: turn off.
	OSD Timer	5 S / 10 S / 15 S / 20 S / 25 S / 30 S		Set OSD disappear time.
OPTION	OSD Language	English		Set the OSD display language.
		Chinese		
	Color Range	Auto		VGA, USB source graying is not optional.
		0-255		
		16-235		
	Aspect Ratio	Auto		VGA signal: 4:3 / 16:9 / PointToPoint.
		16:9		
		4:3		Note: options are different for different channels, input signal formats and image modes. USB channel does not support proportional mode.
		Zoom1		
		Zoom2		
Just Scan				
Panorama				
PointToPoint				
Blue Screen	On/Off			After the blue screen is opened, the no signal interface and menu interface display the blue background.
Restore Factory Default				Recall the default setting.
Soft Update (USB)				software to Update

SCREEN	Auto Adjust			<p>Note: 1. The VGA signal is not connected, so the screen menu cannot be selected; 2. Press up / down key to switch in the process of horizontal position / vertical position / clock / phase adjustment value.</p> <p>When VGA is in the pop-up interface of the automatic adjustment mode, the remote control and the power key have no effect, and the pop-up interface disappears and the system will shut down normally.</p>
	Position H.			
	Position V.			
	Size			
	Phase			
	Position Reset			

Note: Different input sources may have different OSD options, please refer to the actual OSD (on screen display).

5. Compatibility of the USB device

Format of the USB multi-media coder-decoder

Spec of AV codec , Video					
Type	Video coder-decoder	Highest bit rate	Frame rate	Resolution	Audio format
AVI(.avi)	MPEG-1,	80Mbps	30FPS	1920x1080	MPEG-1 Layers I,II, III(MP3) AAC, AC3, PCM, WMA, WMAPro
	MPEG-2MP@HL,	80Mbps	30FPS	1920x1080	
	MPEG-4 SP@L0-3, ASP@L0-5,	50Mbps	30FPS	1920x1080	
	H.264 MP,HP@Level4.1,	100Mbps(VCL) 120Mbps(NAL)	30FPS	3840x2160	
	VC1 (AP),	45Mbps	30FPS	1920x1080	
	H263,	5Mbps	30FPS	1280x720	
	MJPEG,		30FPS	1920x1080	
MPEG-2 TS Transport Stream(. ts)	MPEG-2MP@HL,	80Mbps	30FPS	1920x1080	MP3 AAC AC3 PCM
	MPEG-4SP@L0- 3,ASP@L0-5,	50Mbps	30FPS	1920x1080	
	H.264 MP,HP@Level4.1,	100Mbps(VCL) 120Mbps(NAL)	30FPS	3840x2160	
	AVS benchmark grade@level 6.0,	50Mbps	30FPS	1920x1080	
	VC1 (AP),	45Mbps	30FPS	1920x1080	
	H265	100Mbps	30FPS	3840x2160	
MPEG File Format (.mpeg)	MPEG-1,	80Mbps	30FPS	1920x1080	PCM, AC3, MP3
	MPEG-2MP@HL,	80Mbps	30FPS	1920x1080	
	H.264 MP,HP@Level 4.1,	100Mbps(VCL) 120Mbps(NAL)	30FPS	3840x2160	
	H.264 MP,HP@Level 4.1,	100Mbps(VCL) 120Mbps(NAL)	30FPS	3840x2160	
	MPEG- 4SP@L0-3, ASP@L0-5,	50Mbps	30FPS	1920x1080	
	H265	100Mbps	30FPS	3840x2160	
QuickTime (.mov)	H.264 MP,HP@Level 4.1,	100Mbps(VCL) 120Mbps(NAL)	30FPS	3840x2160	AAC
	MPEG- 4SP@L0-3, ASP@L0-5,	50Mbps	30FPS	1920x1080	
	MJPEG,		30FPS	1920x1080	
	H265	100Mbps	30FPS	3840x2160	

BDAV MPEG-2 transport stream (.m2ts)	H.264 MP,HP@Level 4.1,	100Mbps(VCL) 120Mbps(NAL)	30FPS	3840x2160	AAC3, AAC,
	VC1 (AP),	45Mbps	30FPS	1920x1080	
	MPEG-2MP@HL,	80Mbps	30FPS	1920x1080	
Matroska (.mkv)	H.264 MP,HP@Level 4.1,	100Mbps(VCL) 120Mbps(NAL)	30FPS	3840x2160	
	VC1 (AP),	45Mbps	30FPS	1920x1080	
	H265	100Mbps	30FPS	3840x2160	
Flash Video (.flv)	H.264 MP,HP@Level 4.1,	100Mbps(VCL) 120Mbps(NAL)	30FPS	3840x2160	AAC, MP3
	H263	5Mbps	30FPS	1280x720	
	MPEG-2MP@HL,	80Mbps	30FPS	1920x1080	
Video Object (.vob)					AC3 PCM MP3
DAT (.dat)	MPEG-1,	80Mbps	30FPS	1920x1080	PCM MP3
Advanced Stream Format (.asf)	VC1 (AP),	45Mbps	30FPS	1920x1080	MP3 PCM WMA
	H.264 MP,HP@Level 4.1,	100Mbps(VCL) 120Mbps(NAL)	30FPS	3840x2160	
	MPEG- 4SP@L0-3, ASP@L0-5,	50Mbps	30FPS	1920x1080	
3gp	H.264 MP,HP@Level 4.1,	100Mbps(VCL) 120Mbps(NAL)	30FPS	3840x2160	AMR_NB, AAC
	H263	5Mbps	30FPS	1280x720	
	MPEG- 4SP@L0-3, ASP@L0-5,	50Mbps	30FPS	1920x1080	
tp	MPEG-2MP@HL,	80Mbps	30FPS	1920x1080	MPEG-1 Layers II, AC3
trp	H.264 MP,HP@Level 4.1,	100Mbps(VCL) 120Mbps(NAL)	30FPS	3840x2160	MP3
	MPEG-2MP@HL,	80Mbps	30FPS	1920x1080	

Spec of AV codec , Audio			
Type	Audio format	Sampling Rate	Bit rate
Windows Media Audio (.wma)	WMA WMAPro	8KHz ~ 48KHz	128bps ~ 320Kbps
MPEG Audio Layer III (.mp3)	MPEG	32kHz ~ 48kHz	32kbps ~ 320kbps
Advanced Audio Coding (.aac)	AAC	16kHz ~ 48kHz	24kbps ~ 384kbps
N/A (Work with video files only)	AC3	32kHz, 44.1kHz, 48kHz	32kbps ~ 640kbps
	EAC3	32kHz, 44.1kHz, 48kHz	32Kbps ~ 6 Mbps
OGG Vorbis (.ogg)	Vorbis	8kHz~48kHz	max 320Kbps

Spec of AV codec , Photo		
Type	Maximum resolution	Minimum resolution
png	8K*8K (Hardware solutions)	4*4
jpeg	baseline 8K*8K, (Hardware solutions) progressive 4K*4K	4*4
bmp	8K*8K	4*4

Notes:

- If the standard bite rate/frame rate of the contents is higher than the compatible frames/ second listed in the above table, audio or video may not work.
- Video contents with a bit rate or frame rate higher than the designated rate in the above table may result in discontinuation of video during display.

6. Input mode

PC mode

- 720 x 400 @ 70Hz
- 640 x 480 @ 60Hz
- 640 x 480 @ 75Hz
- 800 x 600 @ 60Hz
- 1024 x 768 @ 60Hz
- 1152 x 870 @ 75Hz
- 1280 x 720 @ 60Hz
- 1280 x 1024 @ 60Hz
- 1366 x 768 @ 60Hz
- 1920 x 1080 @ 60Hz
- 1600 x 900 @ 60Hz
- 1680 x 1050 @ 60Hz
- 1600 x 1200 @ 60Hz

Video mode

- 480P - 60Hz
- 480i - 60Hz
- 576P - 50Hz
- 576i - 50Hz
- 720P - 50Hz/60Hz
- 1080P - 50/60Hz
- 1080i - 50/60Hz
- 4K2K - 30Hz
- 4K2K - 60Hz

7. Cleaning and Troubleshooting

7.1. Cleaning

Caution When Using the Display

- Do not bring your hands, face or objects close to the ventilation holes of the display. The top of the display is usually very hot due to the high temperature of exhaust air being released through the ventilation holes. Burns or personal injuries may occur if any body parts are brought too close. Placing any object near the top of the display could also result in heat related damage to the object as well as the display itself.
- Be sure to disconnect all cables before moving the display. Moving the display with its cables attached may damage the cables and thus cause fire or electric shock.
- Disconnect the power plug from the wall outlet as a safety precaution before carrying out any type of cleaning or maintenance procedure.

Front Panel Cleaning Instructions

- The front of the display has been specially treated. Wipe the surface gently using only a cleaning cloth or a soft, lint-free cloth.
- If the surface becomes dirty, soak a soft, lint-free cloth in a mild detergent solution. Wring the cloth to remove excess liquid. Wipe the surface of the display to remove dirt. Then use a dry cloth of the same type to dry.
- Do not scratch or hit the surface of the panel with fingers or hard objects of any kind.
- Do not use volatile substances such as insect sprays, solvents and thinners.

Cabinet Cleaning Instructions

- If the cabinet becomes dirty, wipe the cabinet with a soft, dry cloth.
- If the cabinet is extremely dirty, soak a lint-free cloth in a mild detergent solution. Wring the cloth to remove as much moisture as possible. Wipe the cabinet. Use another dry cloth to wipe over until the surface is dry.
- Do not use solution that contains oil to clean the plastic parts. Such product damage the plastic parts and void the warranty.
- Do not allow any water or detergent to come into contact with the surface of the display. If water or moisture gets inside the unit, operating problems, electrical and shock hazards may result.
- Do not scratch or hit the cabinet with fingers or hard objects of any kind.
- Do not use volatile substances such as insect sprays, solvents and thinners on the cabinet.
- Do not place anything made from rubber or PVC near the cabinet for any extended periods of time.

7.2. Troubleshooting

Symptom	Possible cause	Solution
No display	<ol style="list-style-type: none"> 1. The power cord has been disconnected. 2. The main power switch on the back of the monitor is not turned on. 3. The selected input is not connected. 4. The monitor is in the standby mode. 	<ol style="list-style-type: none"> 1. Plug the power cord. 2. Make sure the power switch is turned on. 3. Link signals to the monitor.
The monitor receives interference or noise can be heard..	This is caused by the surrounding electrical devices or fluorescent light.	Move the monitor to other positions to check if the interference is reduced.
Abnormal color	The signal wire is not correctly connected.	Make sure the signal wire is firmly connected to the rear of the monitor.
The display is twisted, and there are abnormal patterns.	<ol style="list-style-type: none"> 1. The signal wire is not correctly connected. 2. The input signal is beyond the capability of the monitor. 	<ol style="list-style-type: none"> 1. Make sure the signal wire is firmly connected. 2. Check if the video signal source is beyond the range of the monitor. Please check the specification of the monitor against its specifications.
The displayed picture does not cover the whole screen.	<ol style="list-style-type: none"> 1. The aspect ratio is incorrect. 2. The scanning mode may be incorrectly set in Underscan. 3. If the picture size exceeds the screen size, the scanning mode may need to be set to be Underscan. 	Use the aspect ratio in the screen menu or the self-set zooming function to tune the geometric shape of the screen and the clock frequency parameter.
There is sound, but no picture.	The input source signal wire is incorrectly connected.	Make sure video input and voice input are both correctly connected.

<p>There is picture, but no sound.</p>	<ol style="list-style-type: none"> 1. The input source signal wire is incorrectly connected. 2. The volume is minimized. 3. {Mute} has been enabled. 4. The external loudspeaker is not connected. 	<ol style="list-style-type: none"> 1. Make sure video input and voice input are both correctly connected. 2. Use [+] or [-] button to adjust the volume. 3. Use [M] button to disable Mute. 4. Connect the external loudspeaker and adjust the volume to a proper level.
<p>Some picture elements are dim.</p>	<p>Some pixels on the screen may be not activated.</p>	<p>This monitor is made by very high precision technology. However, sometimes, some pixels on the monitor may still be not displayed. This is not a failure.</p>
<p>There is picture retention on the monitor display after the monitor is powered off. (Examples of motionless pictures include: icon, video game, computer image, and pictures displayed in 4:3 standard mode.)</p>	<p>Too long display of the motionless picture</p>	<p>Never display the motionless picture for a long time, or the monitor will have permanent picture retention.</p>

8. Technical specification

Item	Specification		
	50"	55"	65"
Screen size (effective area)	49.5 inch (126 cm) diagonal line LCD	54.6 inch (138.7 cm) diagonal line LCD	64.5 inch (163.9 cm) diagonal line LCD
Aspect ratio	16:9	16:9	16:9
Pixel number	3840 (H) x 2160 (V)	3840 (H) x 2160 (V)	3840 (H) x 2160 (V)
Dot Spacing	0.2854 (H) x 0.2854 (V) [mm]	0.315 (H) x 0.315 (V) [mm]	0.372 (H) x 0.372 (V) [mm]
Displayable color	8bits+FRC 1.07G Color	8bits+FRC 1.07G Color	8bits+FRC 1.07G Color
Brightness (classic)	300 cd/m ² (classic)	350 cd/m ² (classic)	350 cd/m ² (classic)
Contrast (classic)	5000:1	1200:1	1200:1
Visual angle	178 (Typ.)	178 (Typ.)	178 (Typ.)

Input/output terminal:

Item		Specification
Loudspeaker output	Internal loudspeaker	7 W (L) + 7 W (R) [RMS]/6 Ω
Audio input	3.5Mm Headphone jack x 1	0.5V [rms](normal mode) / 2 sound track (L+R)
VGA input	D-SUB jack (15pin)	Analog RGB: 0.7V [p-p] (75Ω), H/CS/V: TTL (2.2kΩ), MAX: 1920 x 1080/60 Hz (WUXGA)
HDMI input	HDMI interface x 2 (A type) (19 pins)	Digit RGB: TMDS (video + audio setting) Max.: Video – HDMI 1 4K@30Hz HDMI 2 4K@60Hz Audio - 48 KHz/ 2 sound track (L+R) Support LPCM only
USB input	USB2.0 A type x1	USB2.0
RS232	RJ-45 Jack x 1 (8 pin)	RS232 in

General:

Item	Specification		
	50"	55"	65"
Power input	100-240V~, 50/60Hz	100-240V~, 50/60Hz	100-240V~, 50/60Hz
Power consumption (max.)	110 W	145 W	190 W
Power consumption (classic)	90 W	115 W	160 W
Power consumption (standby and power-off)	<0.5 W	<0.5 W	<0.5 W
Dimension (without base) [W x H x D]	1113.0 X 649.0 X 87.2 mm	1222.8 X 713.39 X 85.55 mm	1449.6 X 844.7 X 78.6 mm
Dimension (with base) [W x H x D]	1113.0 X 710.5 X 247.9 mm	1222.8 X 786.86 X 268.87mm	1449.6 X 883.4 X 283.4 mm
Net weight (without base)	10.41 Kg	11.18 Kg	18.6 Kg
Net weight (with base)	10.65 Kg	11.42 Kg	18.75 Kg

Environmental conditions:

Item		Specification
Temperature	Running	0 ~ 40°C
	Storage	-20 ~ 60°C
Temperature	Running	20 ~ 80% RH (no dew)
	Storage	10 ~ 90% RH (no dew)
Altitude	Running	0 ~ 3,000 m
	Storage/transport	0 ~ 9,000 m



Q41G50M108307A