

StreetSiren DoubleDeck Fibra User manual

Updated January 10, 2024



StreetSiren DoubleDeck Fibra is a wired siren of the Ajax system with the ability to install a branded faceplate. Equipped with a LED frame and piezoelectric alarm indicator producing sound volume up to 113 dB. For both indoor and outdoor installation.



The siren is compatible with [Hub Hybrid \(2G\)](#) and [Hub Hybrid \(4G\)](#). Connection to other [hubs](#), [radio signal range extenders](#), [ocBridge Plus](#), and [uartBridge](#) is not provided.

StreetSiren DoubleDeck works as part of the Ajax system, exchanging data with the hub via the secure protocol of Fibra wired technology. The communication range is up to 2,000 m when connected via twisted pair U/UTP cat.5.

StreetSiren DoubleDeck is the device of the Fibra wired product line. The installation, sale, and administration of these devices are performed only by accredited Ajax partners.

Functional elements

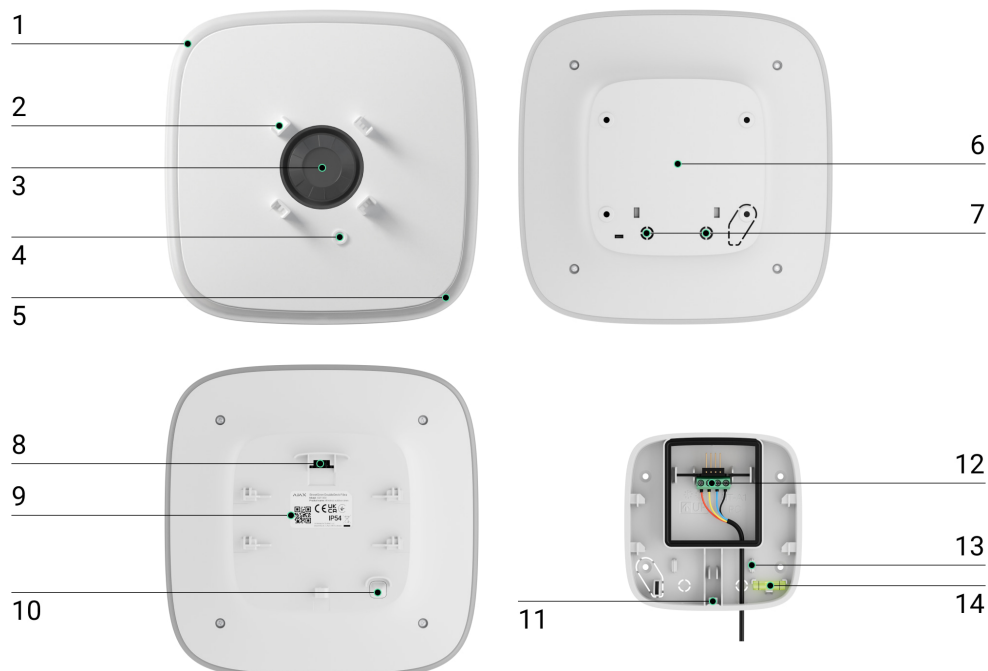

1. LED frame.

2. Latches for mounting the Brandplate.

3. Piezoelectric alarm indicator (buzzer) of the siren. Used for sound notification of alarms and events.

4. Place for fixing the Brandplate faceplate with a screw.

5. LED indicator.

6. SmartBracket mounting panel. To remove the panel, slide it down.

7. Perforated part for the output of Fibra line cables, by which the siren is connected to the hub.

8. QR code and ID (serial number) of the siren. Used for connection to the Ajax system.

9. Tamper button. Triggers when an attempt is made to detach the device from the surface or remove it from the mounting panel.

10. Connector for connecting a siren to a Fibra line.

11. The hole for attaching the SmartBracket mounting panel with a screw.
12. Fasteners to fix the cables with ties.
13. Terminals for connecting StreetSiren DoubleDeck Fibra to the hub.
14. Bubble level to check the inclination angle of the mounting during installation.

Operating principle

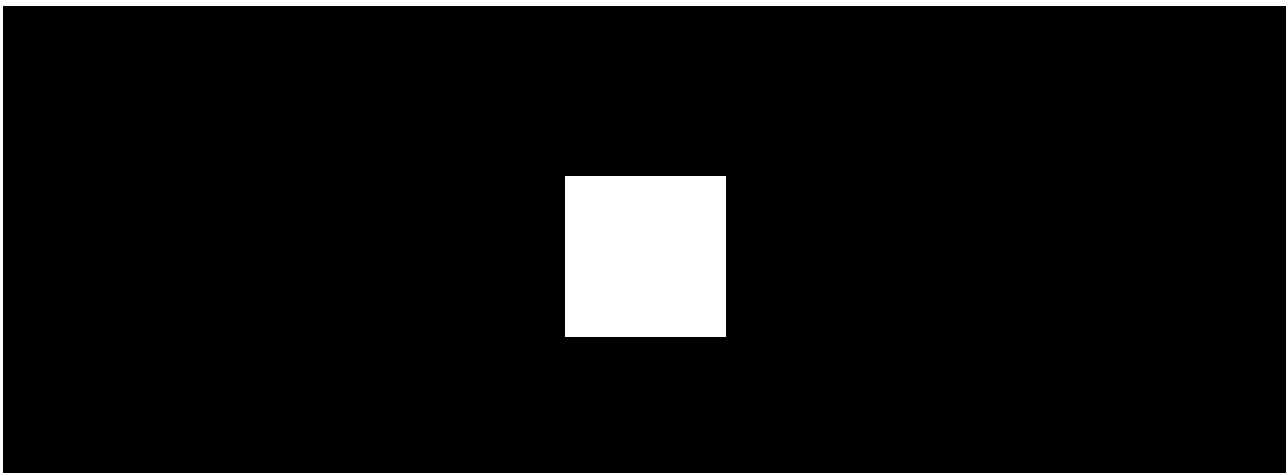

00:00

00:12

StreetSiren DoubleDeck Fibra is a wired Ajax siren with the ability to install a branded faceplate.

The device is equipped with a piezoelectric buzzer for sound alerting and an LED frame for visual alerting. The siren has a sealed battery that is used to power the device. The battery is charged from the Fibra line and is used for an indication as well as notification of alarms and events.

In case of the Fibra line damage or an emergency power shortage, the backup battery will provide the siren with power to indicate and alert alarms and events.

Siren performs four tasks:

1. **Informs about alarms.** The siren responds to system alarms and the triggering of a tamper enabling a buzzer and LED backlight, which scares off intruders and attracts attention.

2. Indicates the security status. The siren, using LED indication, can notify that the object is armed, and inform with a sound signal and backlight about delays when entering/leaving.

What are Delay When Entering and Delay When Leaving

3. Notifies of opening. Sirens with a particular sound inform you about the triggering of the opening detectors when the system is disarmed. The feature is used, for example, in stores, to notify employees that someone has entered the premises.

4. Notifies of triggering until the system is disarmed. The lower right corner of the siren's LED frame flashes after the sound signal is played. Thanks to this option, users and passing patrols of security companies can see that the system was triggered.

Alarm volume and duration

By alarm the siren sounds from 3 seconds to 3 minutes, emitting a sound volume of 85 to 113 dB. In the Ajax apps, you can set the duration and volume of the alarm, as well as determine which devices will activate the siren.

Protection against sabotage

StreetSiren DoubleDeck is equipped with a tamper and raises the alarm when the main power (from the Fibra line) is lost. The tamper is triggered when the siren is removed from the mount and when the casing is opened or damaged.

In the event of sabotage, the users and the security company know exactly which siren the intruders are trying to disable. The notifications contain the hub name (name of the protected object), the incident time, the siren name, the alarm type, and the virtual room to which the device is assigned.

StreetSiren DoubleDeck has a pre-installed battery. It provides the siren with the power to indicate and notify of alarms and events as well as in case of damage to the Fibra line or an emergency power shortage.

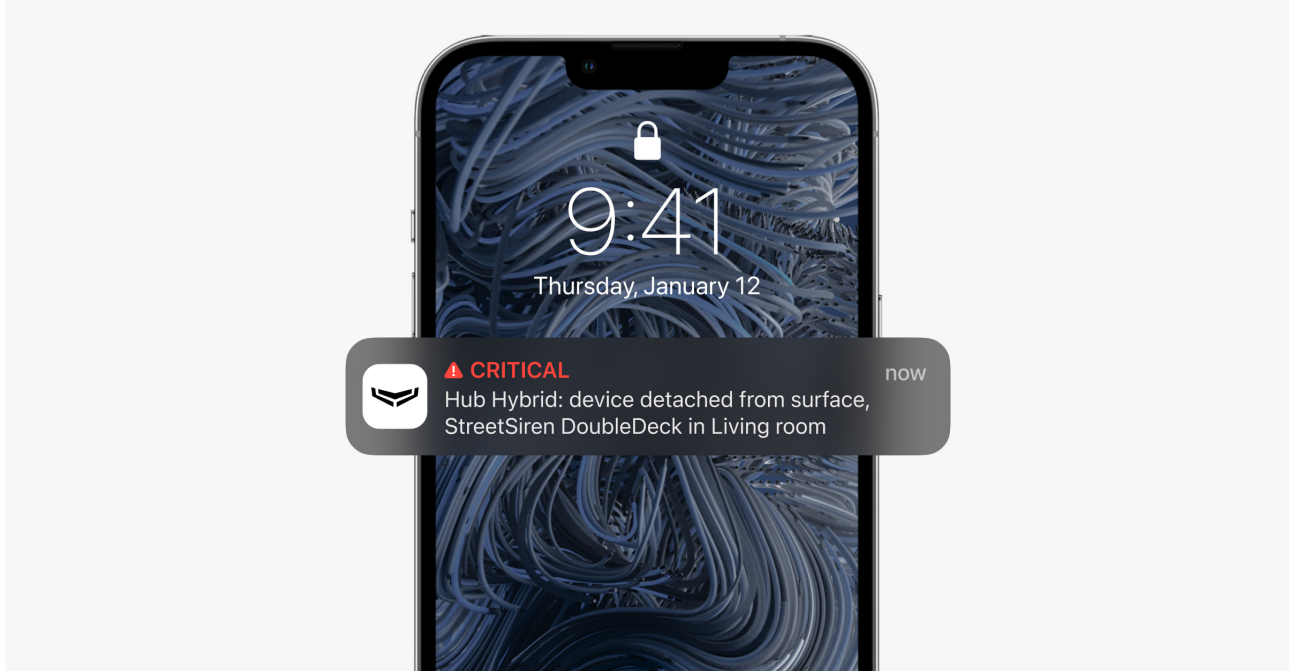

Fibra data transfer protocol

The siren uses Fibra technology to transmit alarms and events. This is a wired data transfer protocol that provides fast and reliable two-way communication between the hub and the connected devices. Using the bus connection method, Fibra delivers alarms and events instantly, even if 100 devices are connected to the system.

Fibra supports block encryption with a floating key and verifies each communication session with devices to prevent sabotage and spoofing. The protocol requires regular polling of devices by the hub with a predetermined frequency to monitor communication and display the status of the system devices in the Ajax apps.

[Learn more](#)

Sending events to the monitoring station

The Ajax system can transmit alarms to the [PRO Desktop](#) monitoring app, as well as to the central monitoring station (CMS) using **SurGard (Contact ID)**, **SIA (DC-09)**, **ADEMCO 685**, and [other protocols](#).

StreetSiren DoubleDeck can transmit the following events:

1. Tamper alarm/recovery.

2. Alarm due to loss/recovery of the main power.
3. Loss/recovery of connection between StreetSiren DoubleDeck and the hub.
4. Turning the siren off/on.
5. Battery discharge/charge.
6. Battery disconnection/connection.

When an alarm is received, the monitoring station operator of the security company knows what happened and where the rapid response unit has to be sent. Addressability of Ajax devices allows you to transmit to PRO Desktop and to the CMS events, device type, its assigned name and location (room, group). The list of transmitted parameters may differ depending on the type of CMS and the selected communication protocol.



Device ID, loop (zone) number, as well as line number can be found in its [states](#).

Selecting the installation site



When choosing where to install the StreetSiren DoubleDeck, consider the parameters that affect the operation of the siren:

- Fibra signal strength.
- Cable length for connecting StreetSiren DoubleDeck.
- Audibility of StreetSiren DoubleDeck sound signal.

- Visibility of StreetSiren DoubleDeck LED indication.

StreetSiren DoubleDeck withstands heat, cold, and temperature fluctuations. The siren is protected from rain and snow and can be installed on the facade of the building without a canopy. The siren enclosure has an IP54 protection class.



The recommended installation height is **2.5 meters or more**. This raises difficulties for intruders to gain access to the device in the event of a sabotage attempt. If the siren cannot be placed at this height, it can be installed lower.

Follow placement recommendations when designing the Ajax system for an object. The security system should be designed and installed by professionals. The list of authorized Ajax partners is [available here](#).

Do not install the siren

1. Near glass break detectors. The siren sound may trigger an alarm.
2. In places where the audio signal of the siren can be jammed.
3. In places where the LED indication of the siren will not be visible.
4. In places with low or unstable Fibra signal strength.

Fibra Signal Strength

The Fibra signal strength is determined by the ratio of the number of undelivered or corrupted data packages to those expected over a certain period of time. The icon  in the **Devices**  tab in Ajax apps indicates the signal strength:

- **Three bars** – excellent signal strength.
- **Two bars** – good signal strength.
- **One bar** – low signal strength; stable operation is not guaranteed.
- **Crossed out icon** – no signal; stable operation is not guaranteed.

The following factors affect the signal strength:

- The number of devices connected to one Fibra line.

- Cable length and type.
- The correctness of the wire connections to the terminals.

What is Fibrá Signal Strength Test

Designing

To correctly install and configure the devices, it is important to properly design the system. The design must take into account the number and types of devices at the object, their exact location and installation height, the length of Fibrá wire lines, the type of cable used, and other parameters. Tips for designing wired Fibrá systems are available [in this article](#).

Topologies

Ajax security systems support two topologies: **Beam (Radial wiring)** and **Ring**.



Connecting devices using a **Ring** topology will be implemented in the next OS Malevich updates. Hardware update of Hub Hybrid is not required.

Beam connection occupies one line output of the hub. In the event of a line break, only the segment that remains physically connected to the hub will function. All devices connected after the breakpoint will lose connection with the hub.

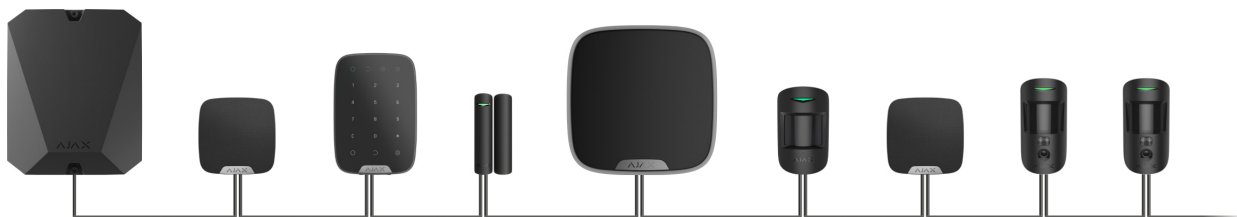

Ring connection method occupies two line outputs of the hub. If the ring breaks in one place, no device will be disabled. The ring reconfigures into two lines, which continue to operate normally. Users and security company will receive notification about break.



Beam (Radial wiring)	Ring
Occupies one line output of the hub. Up to 8 lines on the same hub. Up to 2,000 m of wired communication for the same line. A termination resistor is installed at the end of the line.	Occupies two line outputs of the hub. Up to 4 rings on the same hub. Up to 500 m of wired communication for the same ring. No termination resistor is installed at the end of the line.

Both device connection topologies can be used on the same hub. For example, you can use two Ring connections and four **Beam** topology connections.

Different types of devices can be connected to a single Fibra line. For example, you can connect opening detectors, motion detectors with photo verification support, sirens, and keypads to the same line.

The devices are connected to the Fibra line one by one, as shown on the figure. Branching of lines is not allowed.

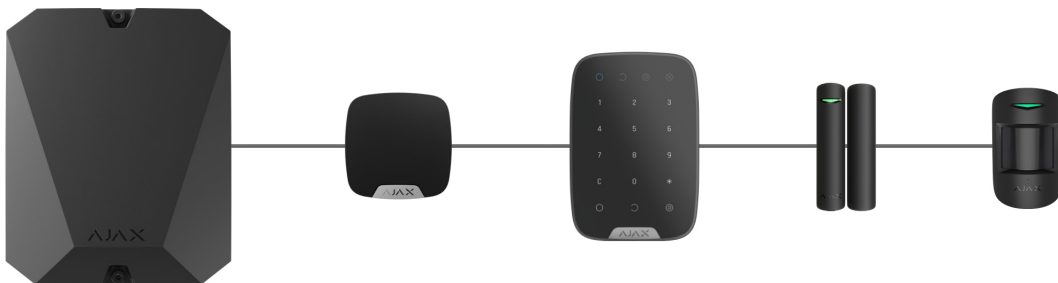

For the **Beam (Radial)** topology, be sure to install a 120 Ohm terminating resistor at the end of the line (included in the hub complete set). The terminating resistor is connected to the signal terminals of the last device on the line.

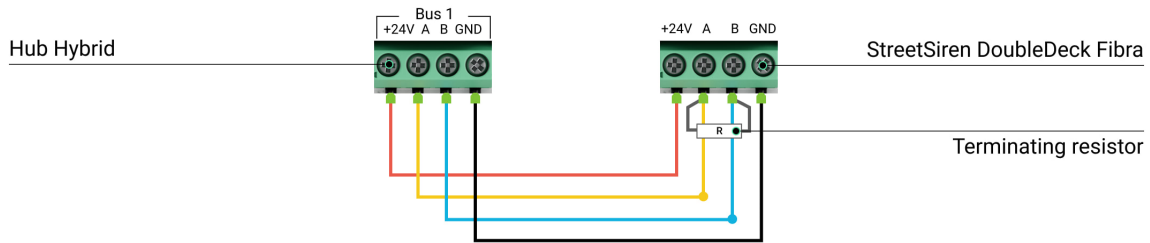

Cable length and type

The maximum communication range for wired connection using the **Beam (Radial)** topology is 2,000 meters, and that using the **Ring** topology is 500 meters.



Recommended cable types:

- U/UTP cat.5 4 × 2 × 0.51, copper conductor.
- Signal cable 4 × 0.22, copper conductor.

If you use a different type of cable, the communication range for wired connections may vary. No other types of cables have been tested.

Verification using a calculator

To make sure that the project is calculated correctly and such a system will work in practice, we have developed a [Fibra lines distance calculator](#). The calculator helps to check the quality of communication and cable length for wired Fibra devices with the selected configuration at the system design stage.

Preparing for installation

Cable arrangement

When preparing to lay cables, check the electrical and fire safety regulations in your region. Strictly follow these standards and regulations.

It is safest to route cables inside walls, floors, and ceilings; this way, they will be invisible and unavailable for intruders. It also ensures greater durability: the

cable will be affected by fewer external factors that can impact the wear of the conductor and its insulating layer.

As a rule, system cables are laid at the construction or repair stage, after the object has been wired.

If impossible to install cables inside the walls, route them so that the cable is sufficiently protected and hidden from prying eyes. For example, in a cable conduit or a protective corrugated pipe. It is recommended to hide them. For example, behind the furniture.

Regardless of whether the cable is routed inside the wall or not, it is recommended to use protective pipes, cable conduits, or corrugated pipes to protect cables. The cables should be arranged carefully; no sagging, tangling, or twisting is allowed.

Consider the locations of possible signal interference. If the cable is routed near motors, generators, transformers, power lines, control relays, and other sources of electromagnetic interference, use twisted-pair cable in these areas.

Cable routing

When laying cables, take into account not only the general requirements and rules for electrical installation work but also the specifics of the installation of each device: installation height, method of fastening, how the cable is inserted into the casing, and other parameters.

Before installation, we recommend you read the [Selecting the installation site](#) section of this manual. Avoid deviations from the system project. Violation of the basic installation rules and the recommendations of this manual may lead to incorrect operation, as well as loss of connection with the StreetSiren DoubleDeck.

Check the cables for bends and physical damage before routing. Replace the damaged cables.

The signal cables for the system devices must be laid at a distance of at least 50 cm from the power cables when laid in parallel, and at the angle of 90° in case of their intersection.

Observe the permissible bend radius of the cable. It is specified by the manufacturer in the cable specifications. Otherwise, you risk damaging or breaking the conductor.

Preparing cables for connection

Remove the insulating layer of the cable and strip the cable with a special insulation stripper. The ends of the wires that will be inserted into the terminals of the device must be tinned or crimped with a sleeve. This ensures a reliable connection and protects the conductor from oxidation. Recommended cable lug sizes: 0.75 to 1 mm².

Installation and connection

Mounting the Brandplate

In order to mount the faceplate:

1. Unscrew the fixing screw from the bottom of the siren with a PH2 screwdriver if the siren is mounted on the SmartBracket mounting plate.



2. Remove the siren from the SmartBracket mounting panel. To do this, lightly press the panel and slide it down.
3. Place the front side of the siren on a hard surface and unscrew the 4 screws on the rear panel with a PH2 screwdriver.



4. Turn the siren over while holding the front and back of the body. Remove the protective plastic panel.



When installing the panel, do not remove the plastic frame and do not remove the LED strip from the seat.

5. Drill a hole in the plastic protective plate at the defined location.



6. Mount Brandplate on the protective plastic panel.



7. Fix the Brandplate to the protective plastic panel using the bundled bolt.

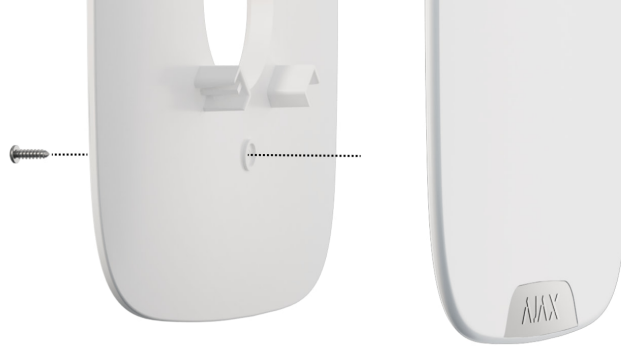

8. Fit the protective plastic panel in place (the Ajax logo on the connection side of the LED strip to the board) with little effort. The properly mounted plastic panel will protrude above the LED frame no more than 1.0 to 1.5 mm.
9. Turn the siren over while holding the front and back of the body, and tighten 4 screws.
10. Slide the device onto the SmartBracket mounting panel.

Connecting StreetSiren DoubleDeck Fibra to a hub

1. Turn off lines power in [Ajax PRO app](#). The function is available in the lines menu:
 1. Hub → Settings → Lines → Lines Power Supply.
2. Plug the cable for the device connection into the hub casing. Connect the wires to the required hub line.

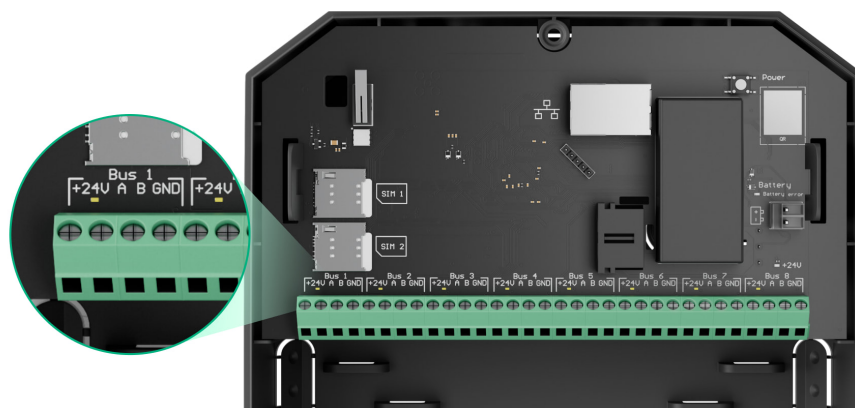

+24V – 24 V= power terminal.

A, B – signal terminals.

GND – ground.

3. Remove the SmartBracket mounting panel from the device and cut out the perforated part to output cables from the bottom of the siren or through the wall.



- 1 – for the output of cables through the wall.
- 2 – for cable output from the bottom of the siren.

4. If the siren is not the last device on the line, prepare a second cable in advance. The ends of the wires of the first and second cables that will be inserted into the terminals of the device should be tinned and soldered together.
5. Connect the wires to the terminals according to the figure below. Follow the polarity and connection order of the wires. Securely fasten the cable to the terminals. Secure the cable with ties.

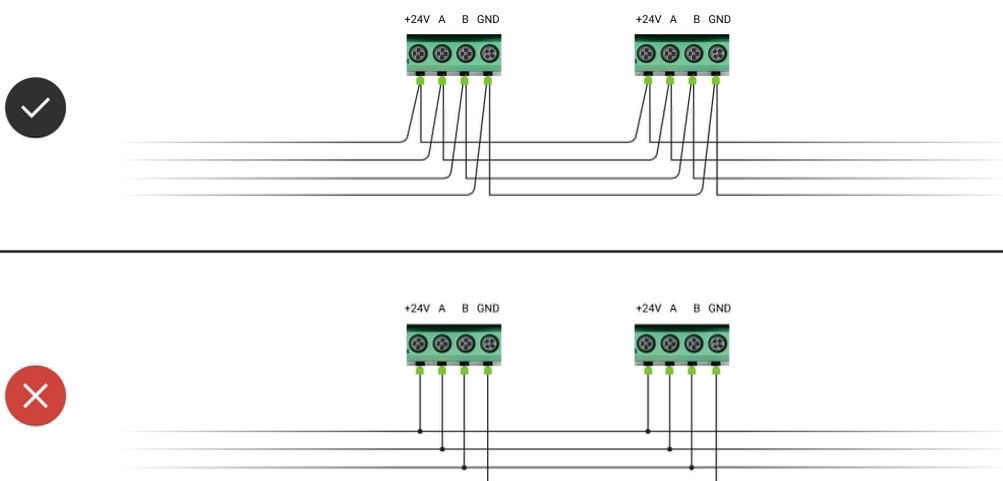

- +24V** – power phase
- A, B** – signal terminals
- GND** – ground

6. If the siren is the last device in the line and the **Beam connection** topology is used, install a terminating resistor by connecting it to the signal terminals of the device. When **Ring connection** is used, a terminating resistor is not needed.
7. Temporarily attach the SmartBracket panel to a vertical surface. This is necessary to run the device tests. The recommended installation height is 2.5 meters or more.
8. Install the device on the SmartBracket mounting panel.
9. Turn on lines power in the [Ajax PRO app](#) (Hub → Settings → Lines → Lines Power Supply). When power is applied, the LED lighting will notify you that the device is turned on.
10. [Add StreetSiren DoubleDeck to the hub.](#)
11. Run the [Fibra Signal Strength Test](#). The recommended signal strength is two or three bars. If the signal strength is one or zero bars, check the connection correctness and the cable integrity.

How to test operability in a correct way

12. Run the [Volume Level Test](#). If the siren is hard to hear, change the volume or move the device.
13. If the siren passes the tests, fix the SmartBracket mounting panel with bundled screws using at least two fixing points (one of them is in the perforated part of the mount above the tamper).



Don't use double-sided adhesive tape for the fixation of a siren, as the device may unstick from the surface at any time.

14. Slide the device onto the SmartBracket mounting panel and fix it with the bundled screw. This reduces the risk of device burglary or sabotage.



Adding to the system



The siren is only compatible with [Hub Hybrid \(2G\)](#) and [Hub Hybrid \(4G\)](#). Only a user with administrator rights can add and configure Fibra devices in Ajax PRO apps.

[Types of accounts and their rights](#)

Before adding a device

1. Install the [Ajax PRO app](#). Sign in to the PRO account.
2. Add a hub compatible with the siren to your app. Set the desired settings and create at least one [virtual room](#).
3. Make sure that the hub is on and has Internet access via Ethernet and/or mobile network. You can do this in the Ajax app or by looking at the hub's LED indicator. It should light up white or green.
4. Make sure the hub is disarmed and is not updated by checking its status in the Ajax app.
5. Make sure the siren is physically connected to the hub.

How to add StreetSiren DoubleDeck Fibra

Two ways to add sirens are available through the Ajax PRO app: automatically and manually.

To add the siren automatically:

1. Open the [Ajax PRO app](#). Select the hub you want to add StreetSiren DoubleDeck Fibra to.
2. Go to the **Devices**  tab and select **Add Device**.
3. Select **Add All Fibra Devices**. The hub will scan the Fibra lines. After scanning, all devices connected to the hub that have not yet been added to the system will be shown.
4. Select the device from the list. After pressing, the LED indicator will flash to identify this device.
5. Set the device name, and specify the room and security group if the [Group mode](#) is enabled. Press **Save**.

To add a siren manually:

1. Open the [Ajax PRO app](#). Select the hub you want to add StreetSiren DoubleDeck Fibra to.
2. Go to the **Devices**  tab and select **Add Device**.
3. Assign a name to the device.
4. Scan or type in the QR code manually. The QR code is located on the back of the enclosure under the SmartBracket mounting panel and on the packaging.
5. Select a virtual room and a security group (if the [Group mode](#) is enabled).
6. Press **Add**.

If the connection fails, check if the wired connection is valid and try again. If the hub already has the maximum number of devices added (for Hub Hybrid, the default value is 100), you will get an error notification when you add one.



Up to 10 sirens or keypads with a built-in siren can be connected to one hub.



StreetSiren DoubleDeck works with one hub only. After connecting to a new hub, the siren stops exchanging commands with the old one. Once added to a new hub, StreetSiren DoubleDeck is not removed from the device list of the old hub.

Functionality testing

Tests available for StreetSiren DoubleDeck Fibra:

- **Fibra Signal Strength Test.** The test allows you to check a signal strength and stability at the installation site.
- **Volume Test.** Allows you to check the current siren volume level and select the optimal volume level for the protected object.





To run a test:

1. Select a hub in the [Ajax PRO app](#).
2. Go to the **Devices**  menu.
3. Select StreetSiren DoubleDeck.
4. Go to the StreetSiren DoubleDeck settings by clicking on the gear icon .
5. Select:
 1. [Fibra Signal Strength Test](#).
 2. [Volume Level Test](#).
6. Run the test following the prompts of the app.

Icons

The icons show some of the device states. You can view them in Ajax apps:

1. Select a hub in the Ajax app.
2. Go to the **Devices**  tab.
3. Find the StreetSiren DoubleDeck in the list.

Icon	Meaning
	Fibra Signal Strength – displays the signal strength between the hub and the siren. Recommended values: 2–3 bars. Learn more
	Siren notifies about the opening. Learn more
	The charge level of the device battery.
	StreetSiren DoubleDeck is disabled. Learn more
	StreetSiren DoubleDeck tamper triggering events are disabled.

	Learn more
	<p>The device was not transferred to the new hub.</p> <p>Learn more</p>

States

The states include information about the device and its operating parameters. StreetSiren DoubleDeck states can be found in the Ajax apps:

1. Select a hub in the Ajax app.
2. Go to the **Devices**  tab.
3. Select **StreetSiren DoubleDeck** from the list of devices.

Parameter	Meaning
Malfunction	<p>Clicking on  opens the list of StreetSiren DoubleDeck malfunctions.</p> <p>The field is displayed only if a malfunction is detected.</p>
Temperature	<p>Siren temperature.</p> <p>The acceptable error between the value in the app and the temperature at the installation site: 2°C.</p> <p>The value is updated as soon as the siren identifies a temperature change of at least 1°C.</p> <p>You can configure a scenario by temperature to control automation devices.</p> <p>Learn more</p>
Fibra Signal Strength	<p>Signal strength between the hub and StreetSiren DoubleDeck Fibra. Recommended values: 2–3</p>



	<p>bars.</p> <p>Fibra is a protocol for transmitting StreetSiren DoubleDeck events and alarms.</p> <p><u>Learn more</u></p>
<p>Connection via Fibra</p>	<p>The status of connection between the hub and the siren:</p> <ul style="list-style-type: none"> • Online – the siren is connected to the hub. • Offline – the siren has lost connection with the hub. Check the siren connection to the hub.
<p>Line Voltage</p>	<p>The voltage value on the Fibra line to which the siren is connected.</p>
<p>Battery Charge</p>	<p>The battery charge level of the device. Two statuses are available:</p> <ul style="list-style-type: none"> • OK. • Battery low. <p>The indication of the battery charge on the Fibra line is displayed with the  icon.</p>
<p>Lid</p>	<p>The tamper status that responds to the detachment of the device from the surface or violation of the device’s casing integrity:</p> <ul style="list-style-type: none"> • Closed – the siren is installed on the SmartBracket mounting panel. Normal state of the enclosure. • Front lid open – the integrity of the siren casing has been violated. Check the state of the siren enclosure. • Device detached from surface – the siren has been removed from the SmartBracket mounting panel. Check the mounting of the siren. <p><u>Learn more</u></p>

Alarm Volume	<p>Volume level in case of alarm:</p> <ul style="list-style-type: none"> • Muted – the siren does not sound when the alarm is raised. • Quiet – 85 dB volume. • Loud – 100 dB volume. • Very loud – 113 dB volume. <p>The volume level was measured 1 m away from the siren.</p>
Alarm duration	<p>Duration of sound signal in case of alarm: from 3 seconds to 3 minutes.</p> <p>Sets in increments of 3 seconds.</p>
LED indication	<p>Settings of the siren LED indication:</p> <ul style="list-style-type: none"> • Off – LED indication is off. • Armed – the device’s LED frame flashes every 3 seconds when the system is in Armed mode. • Always – the LED frame of the device flashes every 3 seconds, regardless of the siren security mode. <p><u>Learn more</u></p>
Beeps Settings	
Arming/Disarming	<p>When enabled, the siren notifies about arming and disarming by flashing the LED and a short beep.</p>
Night Mode Activation/Deactivation	<p>When enabled, the siren notifies you when the <u>Night mode</u> is switched on/off by flashing the LED and making a short beep.</p>
Entry Delays	<p>When the option is enabled, the siren signals <u>Delay When Entering</u> with a short beep.</p>
Exit Delays	<p>When the option is enabled, the siren signals <u>Delay When Leaving</u> with a short beep.</p>

Entry Delays in Night Mode	When enabled, the siren beeps to signal about a delay when entering in the <u>Night Mode</u> .
Exit Delays in Night Mode	When enabled, the siren beeps to signal about a delay when leaving in the <u>Night Mode</u> .
Chime on opening	When the option is enabled, the siren notifies about the triggering of the opening detectors in the system mode Disarmed . <u>Learn more</u>
Beep Volume	Volume of the audible notification signal about arming/disarming, entry/exit delay, opening detector triggering: <ul style="list-style-type: none"> • Quiet – 85 dB volume. • Loud – 100 dB volume. • Very loud – 113 dB volume. <p>The volume level was measured 1 m away from the siren.</p>
Permanent Deactivation	Shows the status of the device deactivation function: <ul style="list-style-type: none"> • No – the device operates in normal mode and transmits all events. • Lid only – notifications on the siren tamper triggering are disabled. • Entirely – the device does not follow system commands and does not report alarms or other events. <u>Learn more</u>
Firmware	Siren firmware version.
Device ID	Siren ID/serial number. Also available on the back of the siren casing and its packaging.
Device No.	Siren loop (zone) number.
Line No.	The number of the hub's Fibra line to which the

Settings

To change the siren settings in the Ajax app:

1. Go to the **Devices**  tab.
2. Select **StreetSiren DoubleDeck** from the list.
3. Go to **Settings** by clicking on the gear icon .
4. Set the required settings.
5. Click **Back** to save the new settings.

Settings	Meaning
Name	<p>Siren name. Displayed in the list of hub devices, text of SMS and notifications in the events feed.</p> <p>To change the name, click on the text field.</p> <p>The name can contain up to 12 Cyrillic characters or up to 24 Latin characters.</p>
Room	<p>Choosing a StreetSiren DoubleDeck virtual room.</p> <p>The room name is displayed in the text of SMS and notifications in the events feed.</p>
Alarms in Group Mode	<p>Selecting the group to which the siren is assigned. You can select one or all groups:</p> <ul style="list-style-type: none"> • If the siren is assigned to a certain group, it notifies about alarms and events of this group only. • If the siren is assigned to all groups, it notifies about alarms and events of all groups in the system.

	<p>Regardless of the selected group, the siren will respond to activation and alarms of the <u>Night Mode</u>.</p> <p>The option is displayed if <u>group mode</u> is enabled on the hub.</p>
Alarm Volume	<p>Volume level in case of alarm:</p> <ul style="list-style-type: none">• Muted – the siren does not sound when the alarm is raised.• Quiet – 85 dB volume.• Loud – 100 dB volume.• Very loud – 113 dB volume. <p>The volume level was measured 1 m away from the siren.</p>
Alarm Duration	<p>Duration of a sound signal in case of alarm: from 3 seconds to 3 minutes.</p> <p>Sets in increments of 3 seconds.</p>
LED indication	<p>Settings of the siren LED indication:</p> <ul style="list-style-type: none">• Off – LED indication is off.• Armed – the device’s LED frame flashes every 3 seconds when the system is in Armed mode.• Always – the LED frame of the device flashes every 3 seconds, regardless of the siren security mode. <p><u>Learn more</u></p>
Beeps Settings	<p>Opens the siren beeps settings.</p> <p>A description of all alert settings is <u>available below</u>.</p>

<p>Activate buzzer if lid is open</p>	<p>When the option is enabled, the siren activates when a tamper triggering is detected.</p> <p><u>What is tamper</u></p>
<p>Activate buzzer if power supply from the line is insufficient</p>	<p>When enabled, the siren will be activated when a loss of main power is detected.</p>
<p>Fibra Signal Strength Test</p>	<p>Switches the siren to the Fibra signal strength test mode.</p> <p>The test allows you to check the signal strength between the hub and the siren via the Fibra wired communication protocol to select the optimal installation location.</p> <p><u>Learn more</u></p>
<p>Volume Test</p>	<p>Switches the siren to the volume test mode.</p> <p>The test allows you to check the current siren volume level and select the optimal volume level for the protected object.</p> <p><u>Learn more</u></p>
<p>User Guide</p>	<p>Opens StreetSiren DoubleDeck User Manual in the Ajax app.</p>
<p>Permanent Deactivation</p>	<p>Allows the user to disconnect the device without removing it from the system.</p> <p>Three options are available:</p> <ul style="list-style-type: none"> • No – the device operates normally and transmits all events. • Entirely – the device will not execute system commands, and the system will ignore alarms and other notifications from the device. • Lid only – the system will ignore notifications about the triggering of the device tamper. <p><u>Learn more</u></p>

Unpair Device	Unpairs StreetSiren DoubleDeck, disconnects it from the hub, and deletes its settings.
---------------	----------------------------------------------------------------------------------------

Beeps Settings

Beep on armed mode change

Event	Description	Note
Arming/Disarming	When enabled, the siren notifies you when the system is armed and disarmed by lighting the LED frame and making a short beep.	The brightness of the indication and the volume of the sound signal depend on the siren settings. Light and/or sound indication can be turned off in the siren settings.
Night Mode Activation/Deactivation	When enabled, the siren notifies you when the <u>Night mode</u> is switched on/off by lighting the LED frame and making a short beep.	The brightness of the indication and the volume of the sound signal depend on the siren settings. Light and/or sound indication can be turned off in the siren settings.

Beep on Delays

Entry Delays	When enabled, the siren beeps to signal about a delay when entering. <u>Learn more</u>
Exit Delays	When enabled, the siren beeps to signal about a delay when leaving. <u>Learn more</u>

Entry Delays in Night Mode	<p>When enabled, the siren beeps to signal about a delay when entering in the Night Mode.</p> <p><u>Learn more</u></p>
Exit Delays in Night Mode	<p>When enabled, the siren beeps to signal about a delay when leaving in the Night Mode.</p> <p><u>Learn more</u></p>

Beep when Disarmed

Chime on opening	<p>When this option is enabled, the siren informs you with a short beep that the opening detectors are triggered in the Disarmed system mode.</p> <p><u>Learn more</u></p>
------------------	---------------------------------------------------------------------------------------------------------------------------------------------------------------------------------------------------



Siren beep volume

Beep Volume	<p>Selecting the siren volume level for notifications about arming/disarming, entry/exit delay, and opening:</p> <ul style="list-style-type: none"> • Quiet – 85 dB volume. • Loud – 100 dB volume. • Very loud – 113 dB volume. <p>The volume level was measured 1 m away from the siren.</p>
-------------	------------------------------------------------------------------------------------------------------------------------------------------------------------------------------------------------------------------------------------------------------------------------------------------------------------------------------------------------------

Setting the siren response to device alarms

In Ajax apps, you can separately configure the siren's reaction to the alarms of each detector in the system. The function is useful if you do not need to activate the siren in case of the alarm of a specific device. For example, by the [LeaksProtect](#) leakage detector triggering.

To set the siren response to a device alarm

1. Open the Ajax app.
2. Go to the **Devices**  tab.
3. Select the device from the list for which you want to configure the siren response.
4. Go to the device **Settings** by clicking on the gear icon .
5. Find the **Alert with a siren** option and select the toggles which will activate it. Enable or disable the function.
6. Repeat steps 3-5 for the rest of the system devices.





By default, the siren response is enabled for alarms of all devices in the system.

Setting the tamper alarm response

In Ajax apps, you can configure the siren's response to casing alarms of each system device. When the function is activated, the siren will emit a sound signal when triggering the [tamper button](#) of device.

To set the siren response to a tamper alarm

1. Open the Ajax app.
2. Go to the **Devices**  tab.
3. Select a hub and go to its **Settings** .
4. Select the **Service** menu.

5. Go to section **Sounds and Alerts**.
6. Enable the **Alert with a siren if the hub or detector lid is open** option.
7. Click **Back** to save the new settings.





Tamper button reacts to opening and closing of the casing, regardless of the armed mode of the device or system.

Setting the response to pressing the panic button in Ajax apps

You can configure the siren response to alarm when the panic button is pressed in the Ajax apps.

To configure the siren's response to pressing the panic button in Ajax apps

1. Open the Ajax app.
2. Go to the **Devices**  tab.
3. Select a hub and go to its **Settings** .
4. Select the **Service** menu.
5. Go to section **Sounds and Alerts**.
6. Enable the **Alert with a siren if in-app panic button is pressed** option.
7. Click **Back** to save the new settings.

Setting the siren after-alarm indication

1. The system registers the alarm.
2. The siren sounds the alarm. The duration and volume of the signal depend on the device settings.
3. The lower right corner of the siren LED frame flashes twice (at 3-second intervals) until the system is disarmed.

Thanks to this feature, system users and passing security companies patrols can see that the system was triggered.



The siren after-alarm indication does not work for always active detectors, if the detector was triggered when the system was disarmed.

To enable the siren after-alarm indication, in Ajax PRO app:

1. Go to the siren settings:
 - Hub → Settings → Service → Sounds and Alerts.
2. Specify which events the sirens will inform about by double blinking of the LED indicator before the system is disarmed:
 - Confirmed intrusion/hold-up alarm.
 - Single intrusion/hold-up alarm.
 - Lid Opening.
3. Press **Select Devices** and select the required sirens. The new parameters will be saved.
4. Click **Back**. All settings will be applied.



How to set up Chime

If **Chime on opening** is enabled, the siren informs you with a short beep if the opening detectors are triggered when the system is disarmed. The feature is used, for example, in stores, to notify employees that someone has entered the building.

Notifications are configured in two stages: setting up siren and setting up opening detectors.

What is Chime

To set up a siren

1. Go to the **Devices**  tab.
2. Select the required siren from the list.
3. Go to siren **Settings** by clicking on the gear icon  in the upper right corner.
4. Go to the **Beeps Settings** menu.
5. Enable the **Chime on opening** option in the **Beep when Disarmed** category.
6. Set the volume of the beeps. 3 options are available (the volume level was measured at a distance of 1 meter from the siren):
 1. **Quiet** – 85 dB.
 2. **Loud** – 100 dB.
 3. **Very loud** – 113 dB.



The specified **Beep Volume** also applies to the volume of beeps when arming/disarming and the delay when entering/leaving.

7. Click **Back** to save the settings.
8. Set up the opening detector.

Indication

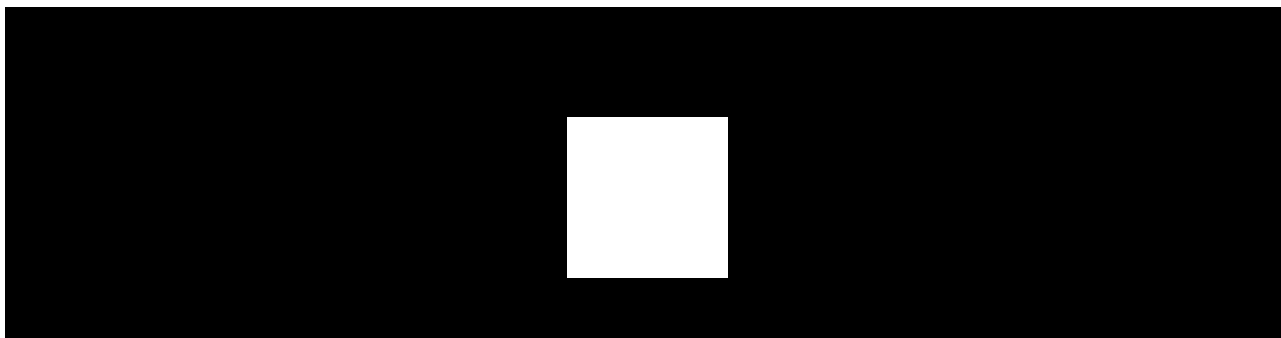

00:00

00:06

Event	Indication	Note
Alarm.	The siren beeps, and the LED frame flashes red.	The duration and volume of the sound signal depend on the siren settings.
An alarm is detected in the armed system (if the post-alarm indication is on).	The siren LED frame flashes red twice in the lower right corner at 3-second intervals until the system is disarmed.	The indication turns on after the siren has fully played the alarm signal.
The system is armed (if Beep on Armed Mode Change is enabled).	The LED frame flashes once, and the siren emits a short beep.	The volume of the sound signal depends on the Beeps Volume settings.
System is disarmed (if Beep on Armed Mode Change is enabled).	The LED frame flashes twice, and the siren emits two short beeps.	The volume of the sound signal depends on the Beeps Volume settings.
Siren in the armed mode (if the indication is configured in Armed mode).	The LED frame in the lower right corner flashes every second.	

Maintenance

Clean the siren enclosure from dust, cobwebs, and other contaminants as they emerge. Use a soft dry cloth suitable for equipment care.

Do not use substances that contain alcohol, acetone, gasoline, or other active solvents to clean the siren.

Technical specifications

[All technical specifications of StreetSiren DoubleDeck Fibra](#)

[Compliance with standards](#)

[Setup in compliance with EN requirements](#)

Complete set

1. StreetSiren DoubleDeck Fibra.
2. SmartBracket mounting panel.
3. Installation kit.
4. Quick Start Guide.

Warranty

Warranty for products of Limited Liability Company "Ajax Systems Manufacturing" is valid for 2 years after purchase.

If the device does not function correctly, please contact Ajax Technical Support first. In most cases, technical issues can be resolved remotely.

[Warranty obligations](#)

[User Agreement](#)

Contact Technical Support

- [email](#)
- [Telegram](#)

Manufactured by "AS Manufacturing" LLC

Subscribe to the newsletter about safe life. No spam

Subscribe