

MotionProtect Jeweller

Wireless indoor IR motion detector.



An Ajax hub is required for operation. Find the detailed information on the device by the link:

 <http://ajax.systems/support/devices/motionprotect/>



2
GRADE
EN 50131

PD 6662
2017

Key features

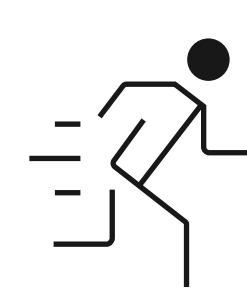

Up to 12 m detection distance

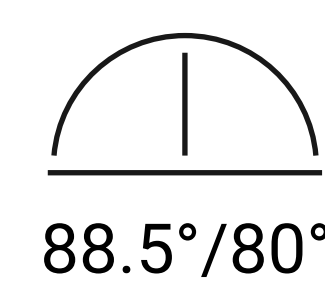

88.5°/80°

88.5°/80° viewing angles

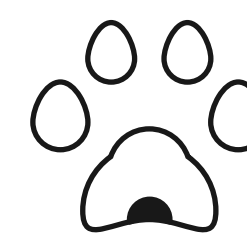

Pet immunity



Temperature compensation



False alarms prevention algorithm

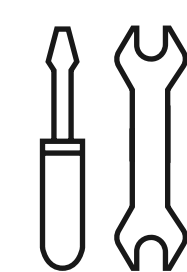

Effortless installation and replacement

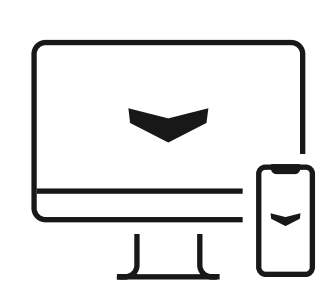

Remote control and setup via the app

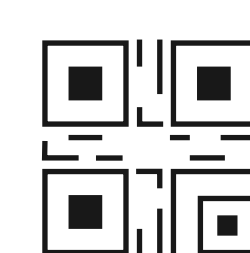

Connecting via QR code

Angles and range

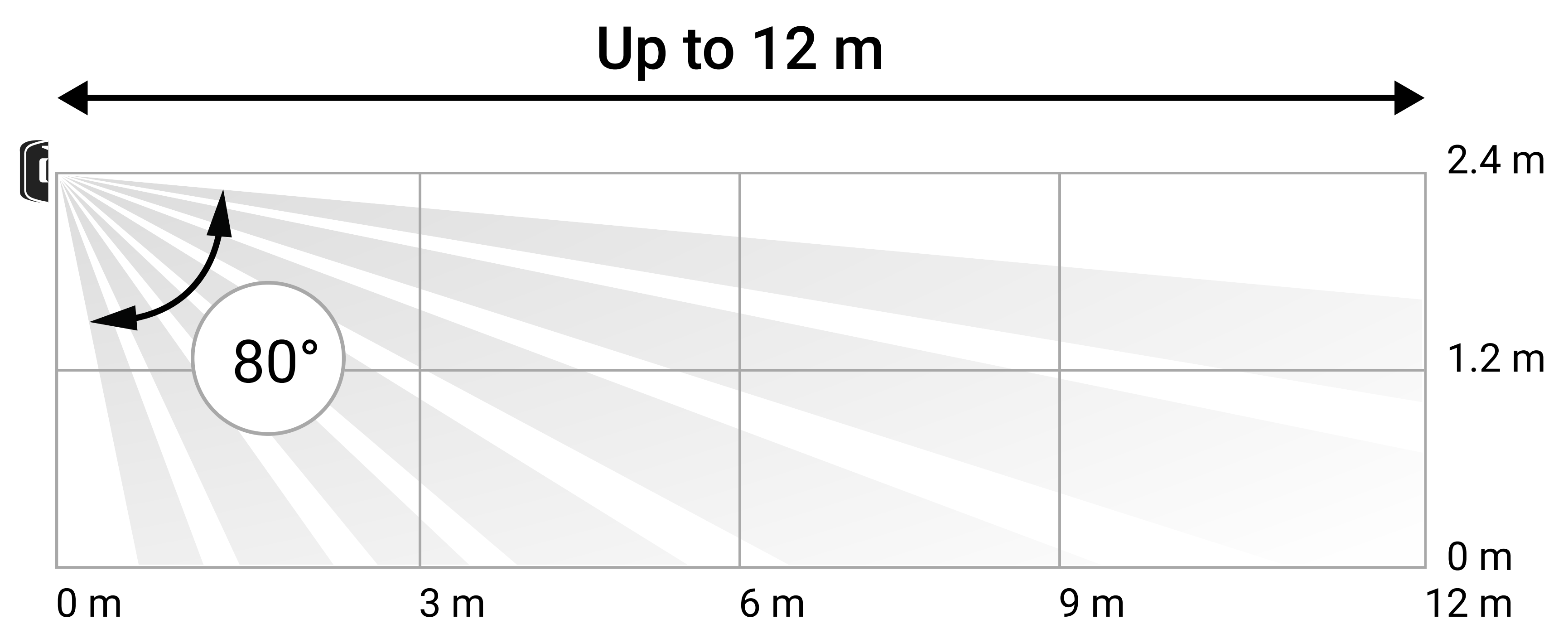
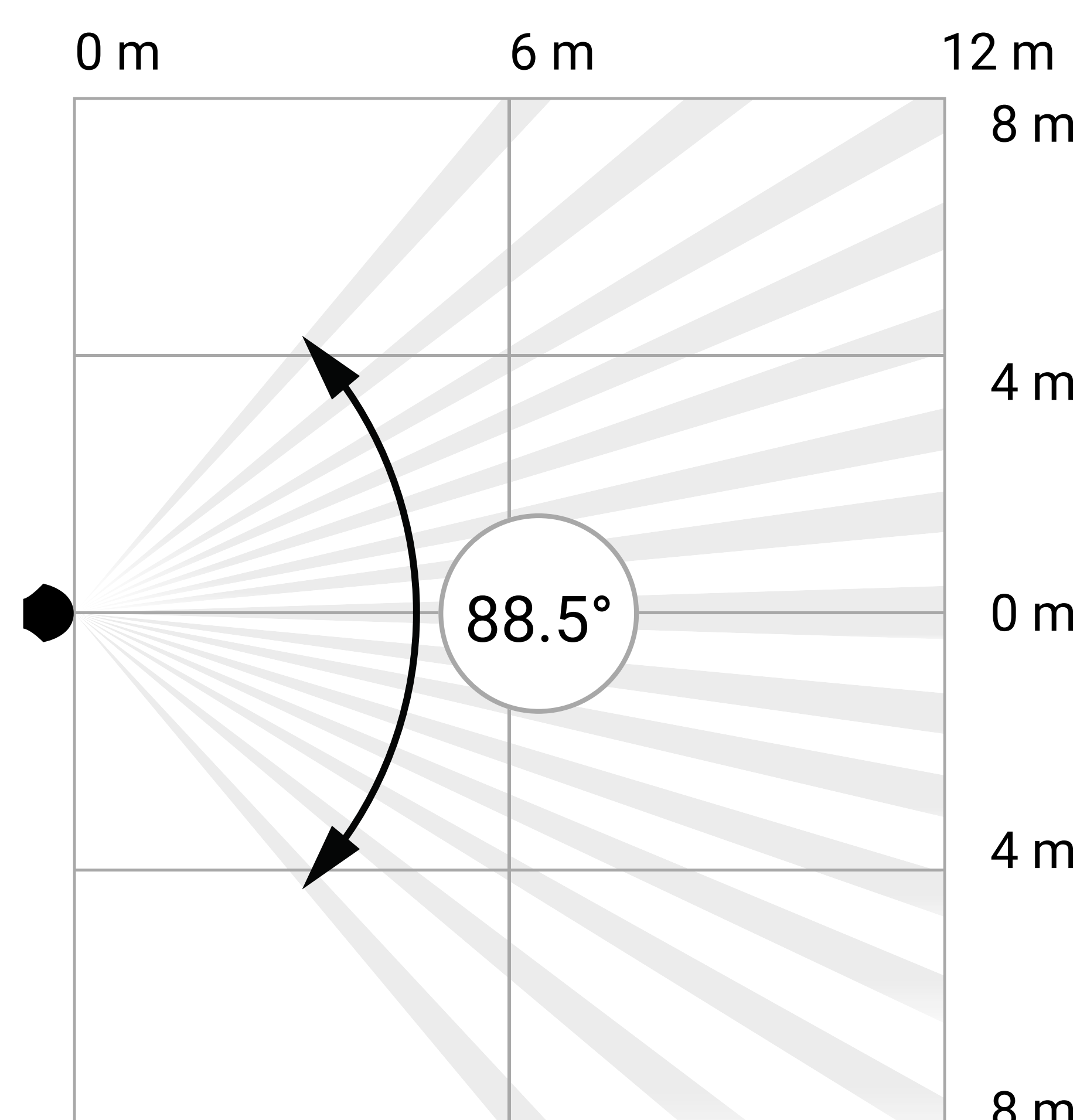

False alarm prevention

MotionProtect Jeweller combines special optics and software to filter false alarms. When professionally installed, the detector ignores pets and doesn't react to the most common sources of false alarms.

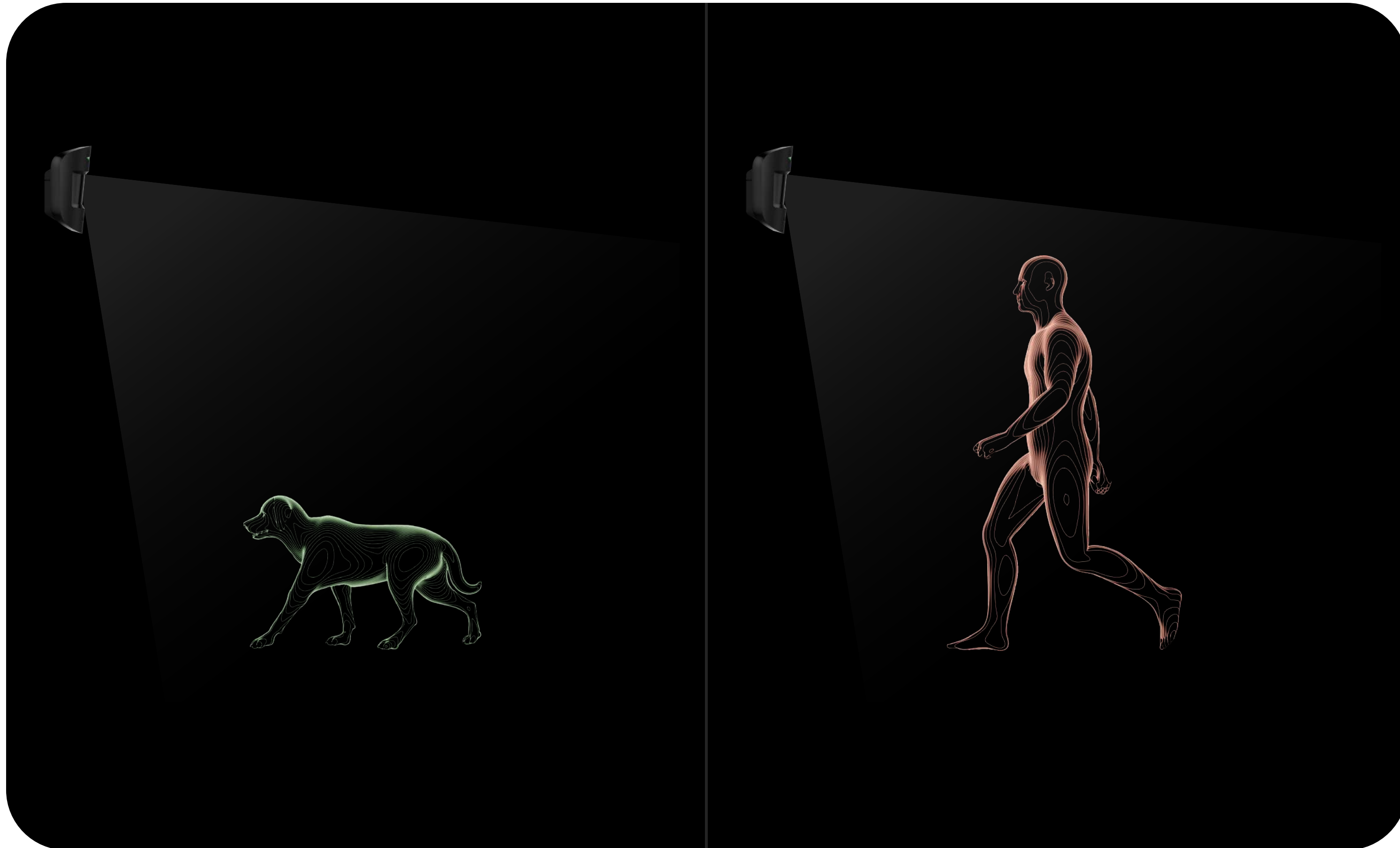

Optics

The detector lens increases sensitivity to human motion, cutting off false alarms to other sources of IR radiation. It is designed so that potential IR radiation from pets and other interferences affect only the small lens sections. Large sections, on the contrary, are aimed at the most likely places of burglar motion.

Software

For additional protection against false alarms, the detector uses the SmartDetect algorithm. The armed detector constantly analyses the thermal diagram from the PIR sensor: the intensity of IR radiation, the size of the thermal spots, the speed of movement and other parameters.

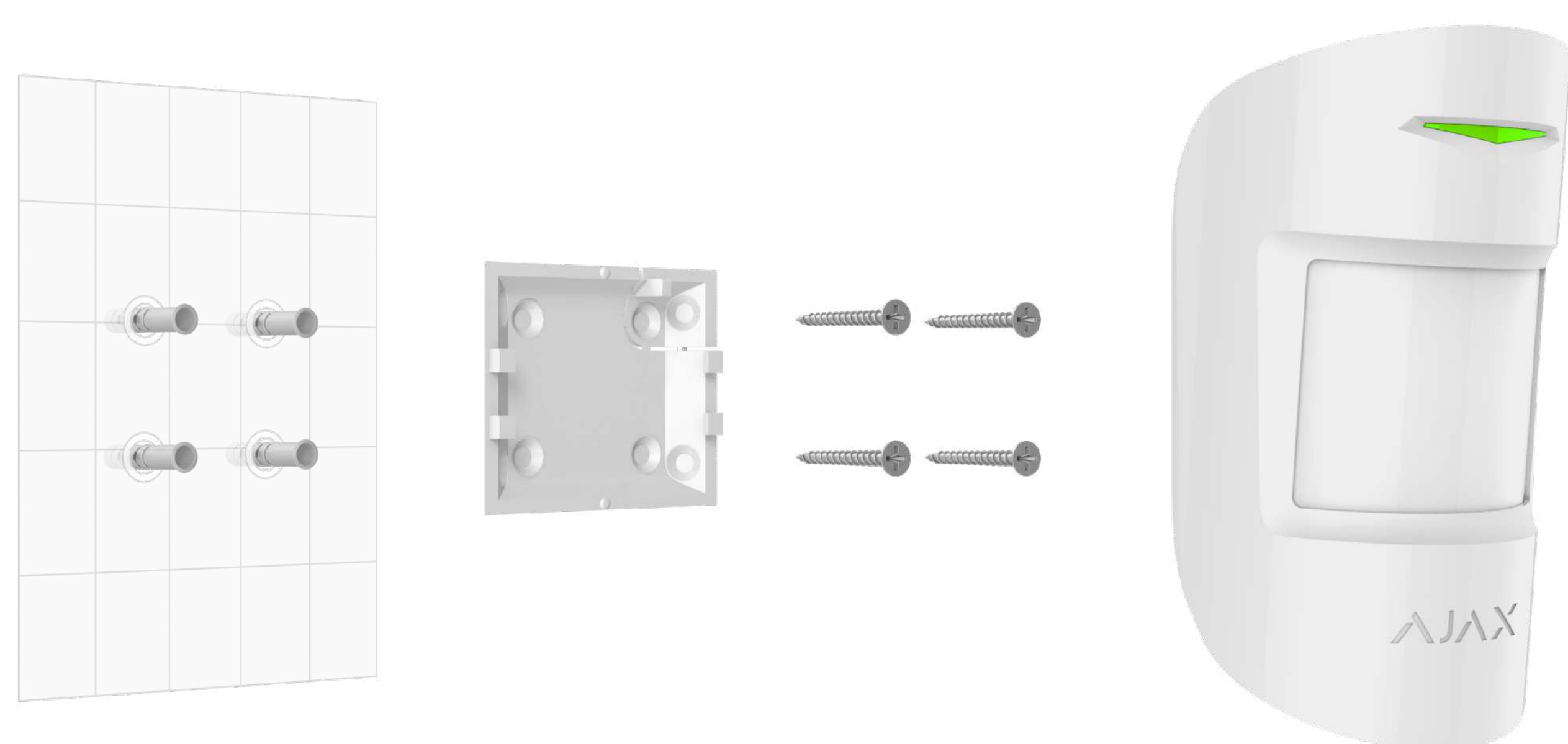
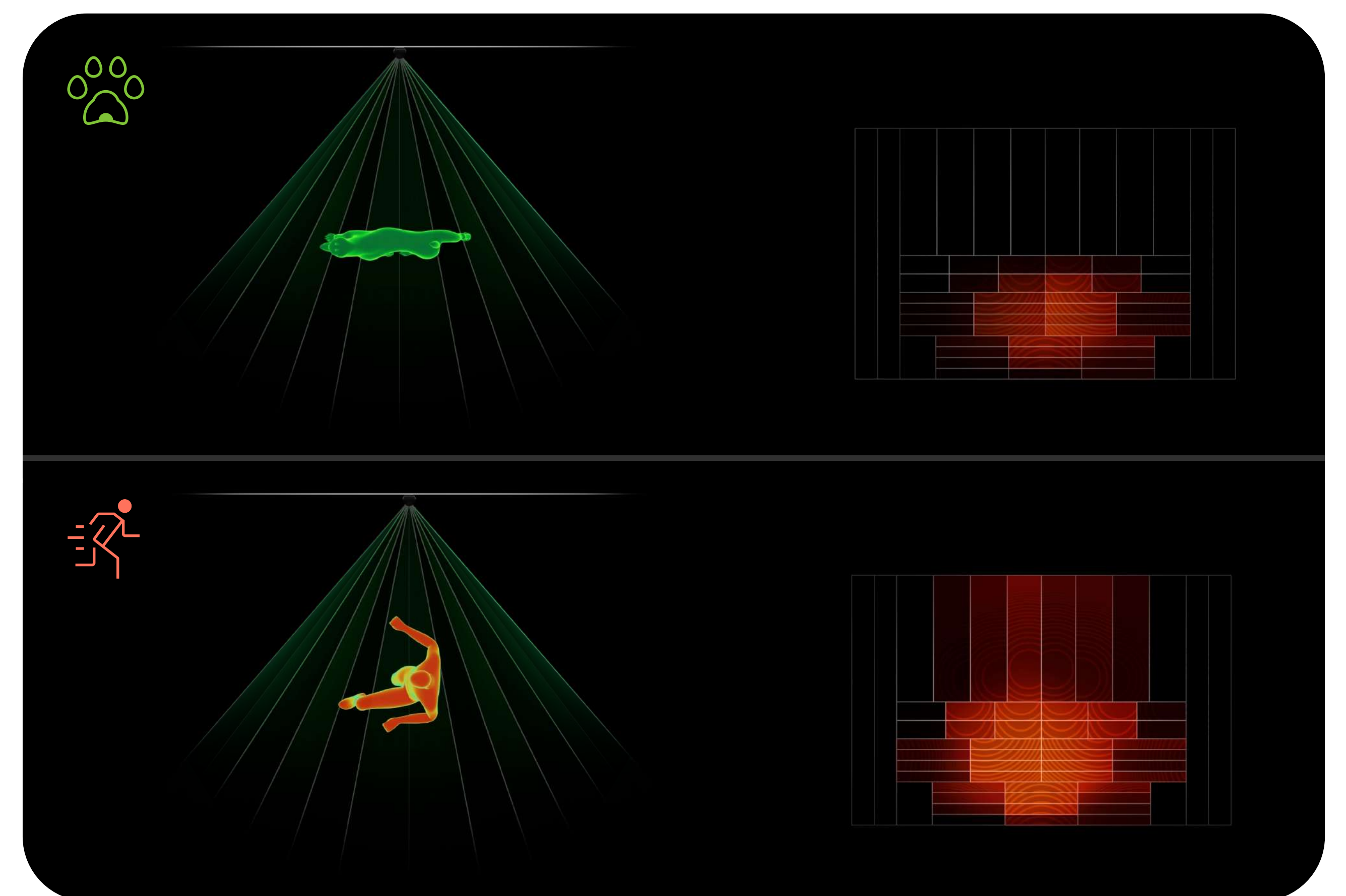

Installation

When properly installed and configured, the detector does not react to common sources of false alarms and pets under 50 cm tall and 20 kg in weight. For seamless installation, it has pre-installed batteries and the SmartBracket mounting panel. So, installers don't need to disassemble the detector and won't damage the electronics during installation.



Jeweller

communication technology



Jeweller is a **two-way wireless protocol** that provides fast and reliable communication between hubs and devices. The protocol delivers instant data-rich alarms: security companies and users know which device was triggered, when and where it happened.

Jeweller features **encryption** and **authentication** to prevent forgery, and **polling** to display devices' status in real time. Supporting **up to 1,700 m** of wireless connectivity, Jeweller is ready to protect facilities and deliver **the best user experience** for both end users and installers.

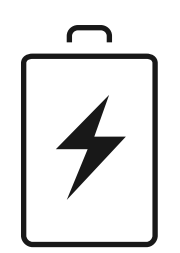

Up to 5 years of operation on pre-installed battery

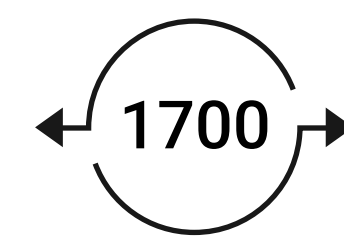

Up to 1,700 m of two-way encrypted wireless communication between hub and detector

Technical specifications

<p>Compliance with standards</p> <p>EN 50131 (Grade 2) PD 6662:2017</p>	<p>Compatibility</p> <p>Hubs all Ajax hubs</p> <p>Range extenders all Ajax radio signal range extenders</p>
<p>Communication with control panel</p> <p> Jeweller communication technology</p> <p>Frequency bands 866.0 – 866.5 MHz 868.0 – 868.6 MHz 868.7 – 869.2 MHz 905.0 – 926.5 MHz 915.85 – 926.5 MHz 921.0 – 922.0 MHz Depends on the region of sales</p>	<p>Motion detection</p> <p>Sensitive element 1 × PIR sensor</p> <p>Detection distance up to 12 m When installed at a height of 2.4 m</p> <p>Detection angles horizontal – 88.5° vertical – 80°</p>

<p>Communication with control panel</p>	<p>Maximum effective radiated power (ERP) $\leq 20 \text{ mW}$</p> <p>Communication range up to 1,700 m In an open space</p> <p>Polling interval 12–300 s Adjusted by PRO or user with admin rights in the Ajax app</p> <p>Protection against forgery Device authentication</p>	<p>Motion detection</p>	<p>Motion detection speed from 0.3 to 2.0 m/s The direction of the detector lens should be perpendicular to an alleged intrusion path into the facility.</p> <p>Temperature compensation</p> <p>Sensitivity 3 levels Adjusted by PRO or user with admin rights in the Ajax app</p> <p>Pet immunity weight: up to 20 kg height: up to 50 cm</p>
<p>Power supply</p>	<p>Battery 1 x CR123A Pre-installed</p> <p>Battery life up to 5 years</p>	<p>Installation</p>	<p>Recommended installation height 2.4 m</p> <p>Operating temperature range from -10°C to $+40^{\circ}\text{C}$</p> <p>Operating humidity up to 75%</p> <p>Protection class IP50</p>
<p>Enclosure</p>	<p>Colour white, black</p> <p>Dimensions 110 × 65 × 50 mm</p> <p>Weight 86 g</p> <p>Tampering alarm</p>	<p>Complete set</p>	<p>MotionProtect Jeweller 1 x CR123A Pre-installed SmartBracket Installation kit Quick Start Guide</p>